

current clamps catalogue



CLAMPS

Chauvin Arnoux has been designing, developing and manufacturing measurement instruments for over one hundred years now. As the inventor of the current clamp in 1934, Chauvin Arnoux masters the principles of current capture and measurement to perfection.

Backed by its in-depth knowledge of practical professional requirements, Chauvin Arnoux is able to provide users with:

- A large number of digital display models for the measurement of harmonics, power and earths, ...
- Together with a large number of special products, developed for customers, or personalised to their specifications.

By combining innovation with technological expertise, Chauvin Arnoux manufactures products with a reputation for quality that comply with international standards.

Chauvin Arnoux,
world leader in current clamps.

the Current Clamps catalogue

ES
TE
NC
EB
TE
NC
OO
CO
FO
OB
IO
AT

Clamps and flexible probes “accessories”

Theoretical overview i.1

Selection guides

AC i.2

AC/DC i.3

Leakage / Scope / Process / CT output i.4

AC current clamps and flexible probes

● MINI series 1.0

● MN series 2.0

● Y series 3.0

● C series 4.0

● D series 5.0

● B series 6.0

● Mini**FLEX** series 7.0

● Amp**FLEX**TM series 8.0

AC/DC current clamps

● K series 9.0

● E series 10.0

● PAC series 11.0

Accessories 12.0

See last page for details of "made to order" model.

A modern method for measuring electrical currents

Introduction

Clamps are designed to extend the current measuring capabilities of DMMs, power instruments, oscilloscopes, hand-held scopes, recorders or loggers, and other diverse instruments.

The clamp is placed around the current-carrying conductor to perform non-contact current measurements without interrupting the circuit under test. The clamp outputs current or voltage signals directly proportional to the measured current, thereby providing current measuring and displaying capabilities to instruments with low current or voltage inputs.

When making a measurement, the current-carrying conductor circuit is not broken and remains electrically isolated from the instrument's input terminals. As a result, the instrument's low input terminal may be either floated or earthed. It is not necessary to interrupt the power supply when using a current clamp for taking measurements, so costly downtime can be eliminated.

True RMS measurements within the clamp's frequency response are possible by using most Chauvin Arnoux current clamps with a true RMS multimeter.

In most cases, RMS measurements are not limited by the clamps, but by the instrument to which they are connected. Best results are provided by clamps offering inherent high accuracy, good frequency response, and minimal phase shift.

Several Chauvin Arnoux clamps are patented for their unique circuitry and design.

AC current clamp

Introduction

An AC current clamp may be viewed as a variant of a simple current transformer.

A transformer (figure 1) is essentially two coils wound on a common iron core. A current I_1 is applied through the coil C1, inducing through the common core a current I_2 in the coil C2. The number of turns of each coil and the current are related by:

$$N_1 \times I_1 = N_2 \times I_2$$

where N_1 and N_2 are the number of turns in each coil.

From this relationship:

$$I_2 = N_1 \times I_1 / N_2 \text{ ou } I_1 = N_2 \times I_2 / N_1.$$

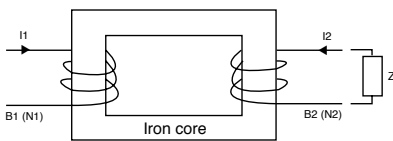

Figure 1

This same principle is applied to a current clamp (figure 2). The articulated magnetic core holds the coil B2 and clamps onto a conductor where the current I_1 is flowing.

B1 is simply the conductor where the user is measuring the current with the number of turns N_1 equal to one. The current sensor clamped around the conductor provides an output proportional to the number of turns in its coil B2, such that:

I_2 (clamp output) = $N_1/N_2 \times I_1$ where $N_1 = 1$ or clamp output = I_1/N_2 (number of turns in the clamp's coil).

It is often difficult to measure I_1 directly because of currents which are too high to be fed directly into a meter or simply because breaking into the circuit is not possible. To provide a manageable output level, a known number of turns is made on the clamp's coil.

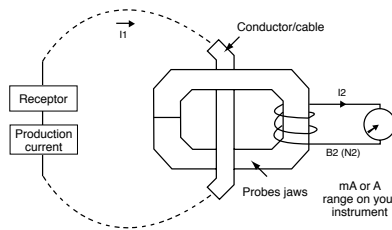

Figure 2

If N_2 equals 1000, then the clamp has a ratio of N_1/N_2 or $1/1000$, which is expressed as 1000:1. Another way to express this ratio is to say that the clamp output is 1 mA/A - the clamp output is 1 mA (I_2) for 1 A (or 1 A @ 1000 A) flowing in the jaw window. There are numerous other ratios possible : 500:5, 2000:2, 3000:1, 3000:5, etc. for different applications.

The most common application is the use of a current clamp with a digital multimeter. Take as an example a current clamp with a ratio of 1000:1 (model C100) with an output of 1 mA/A. This ratio means that any current flowing through the probe jaws will result in a current flowing at the output:

Conductor input	Clamp output
1000 A	1 A
750 A	750 mA
250 A	250 mA
10 A	10 mA

The clamp output is connected to a DMM set on the AC current range to handle the clamp output. Then, to determine the current in the conductor, multiply the reading of the DMM by the ratio (e.g., 150 mA read on the 200 mA DMM range represents $150 \text{ mA} \times 1000 = 150 \text{ A}$ in the conductor measured).

Current clamps may be used with other instruments with current ranges, provided that these instruments have the required input impedance (see figure 3).

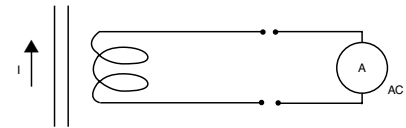

Figure 3

Current clamps may also have AC or DC voltage outputs to accommodate current measurements with instruments (loggers, scopes, etc.) with voltage ranges only (figures 4 and 5).

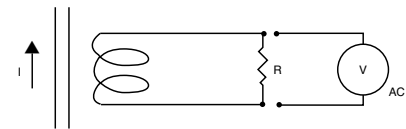

Figure 4

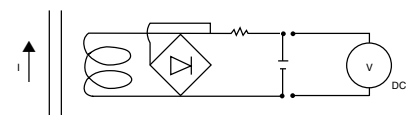

Figure 5

This is simply done by conditioning the current clamp output inside the clamp to provide voltage (e.g., model Y4N or MINI09). In these cases, the probe mV output is proportional to the measured current.

o rAtIn rInCl

The Amp**FLEX**™ and Mini**FLEX** sensors are based on the principle of the Rogowski coil.

The primary circuit is constituted by the conductor carrying the alternating current to be measured, while the secondary is formed by a special coil wound on a flexible support.

At its terminals, this coil develops a voltage proportional to the derivative of the primary current to be measured:

$$u = \frac{\mu_0 \cdot n}{2\pi \cdot r} \times S \cdot \frac{di}{dt}$$

where μ_0 = vacuum permeability
 S = surface area of a turn
 n = number of turns
 r = core radius

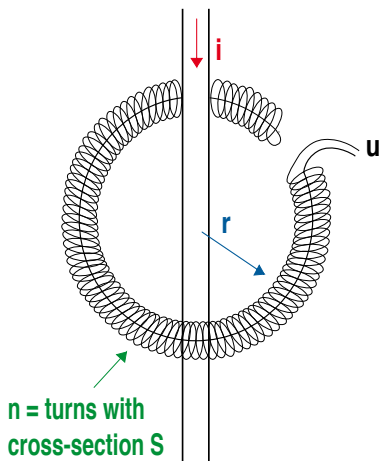

Rogowski coil

This AC voltage u is then passed via a screened cable to the casing containing all the processing electronics and the battery power supply.

Because there are not magnetic circuits on these sensors, they are very lightweight and flexible. Without magnetic circuits, there is no saturation effect or overheating.

This feature offers excellent linearity and low phase shift.

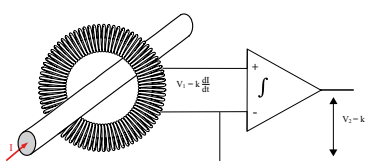

AC/DC Current sensor

t or-o o rAtIon A Ct

Unlike on traditional AC transformers, AC/DC current measurement is often achieved by measuring the strength of a magnetic field created by a current-carrying conductor in a semiconductor chip using the Hall-effect principle.

When a thin semiconductor (figure 6) is placed at right angles to a magnetic field (B), and a current (I_d) is applied to it, a voltage (V_h) is developed across the semiconductor. This voltage is known as the Hall voltage, named after the US scientist Edwin Hall who first reported the phenomenon.

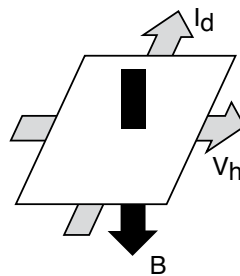

Figure 6

When the Hall device drive current (I_d) is held constant, the magnetic field (B) is directly proportional to the current in a conductor. Thus, the Hall output voltage (V_h) is representative of that current.

Such an arrangement has two important benefits for universal current measurement.

First, since the Hall voltage is not dependent on a reversing magnetic field, but only on its strength, the device can be used for DC measurement.

Second, when the magnetic field strength varies due to varying current flow in the conductor, response to change is instantaneous. Thus, complex AC wave forms may be detected and measured with high accuracy and low phase shift

The basic construction of a clamp jaw assembly is shown in figure 7, (note: one or two Hall generators are used depending on the type of current clamp).

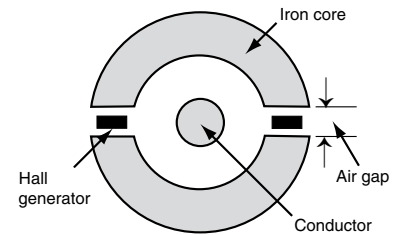

Figure 7

The Chauvin Arnoux AC/DC current clamps were developed using the above principle, together with patented electronic circuitry incorporating signal conditioning for linear output and a temperature compensation network. These have a wide dynamic range and frequency response with highly accurate linear output, for application in all areas of current measurement up to 1,500 A. Direct currents can be measured without the need of expensive, power-consuming shunts, and alternating currents up to several kHz can be measured accurately to respond to the requirements of complex signals and RMS measurements. The clamp outputs are in mV (mV DC when measuring DC, and mV AC when measuring AC) and may be connected to most instruments with a voltage input, such as DMMs, loggers, oscilloscopes, handheld scopes, recorders, etc.

Chauvin Arnoux also offers various technologies for DC measurements, as in the K1 and K2, designed to measure very low DC currents and using saturated magnetic circuit technology.

The AC/DC clamps also offer the opportunity to display or measure True RMS in AC or AC+DC.

AC or DC Current
 Connect the clamp to the instrument
 Select the function and range
 Clamp the clamp around a single conductor
 Read the conductor's current value

Examples (figure 8):

AC: clamp model: Y2N

Ratio : 1000:1
 Output: 1 mA AC/A AC
 DMM: set to 200 mA AC range
 DMM reading: 125 mA AC
 Current in conductor :
 $125 \text{ mA} \times 1000 = 125 \text{ A AC}$

DC : clamp model: PAC 21

1 mV DC/A DC (Hall sensor)
 DMM: set to 200 mV DC range
 DMM reading: 160 mV DC
 Current in conductor: 160 A DC

AC : clamp model: PAC 11

Output : 1 mV AC/A AC
 (Hall sensor)
 DMM: set to 200 mV AC range
 DMM reading: 120 mV AC
 Current in conductor: 120 A AC

DC : micro clamp K1

Output: 1 mV/mA
 DMM: set to 200 mV DC range
 DMM reading: 7.4 mV DC
 Current in conductor: 7.4 mA

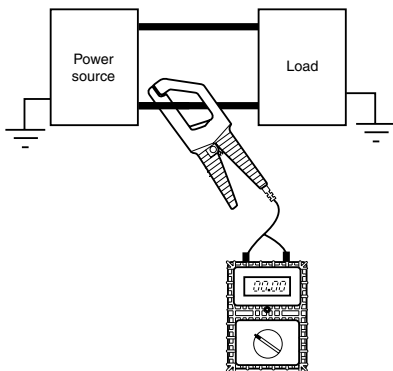

Figure 8

AC or DC Current
 Connect the clamp to the instrument
 Select the function and range
 Clamp the clamp around a single conductor
 Read the conductor's current value

Numerous clamps are offered for low current measurements. For example, models K1 and K2 have a 50 mA DC sensitivity and the model K2 may be used on 4-20 mA process loops.

Example: 4-20 mA loop

Clamp model: K2
 Output: 10 mV/mA
 DMM: set to 200 mV DC range
 DMM reading: 135 mV DC
 Loop current: 13.5 mA DC

When the current to be measured is too low for the clamp or better accuracy is required, it is possible to insert the conductor multiple times through the probe jaws. The value of the current is the ratio of the reading to the number of turns.

Example: figure 9

Clamp model: C100

Ratio: 1000:1
 DMM: set to 200 mA AC range
 Turns in clamp jaw: 10
 DMM reading: 60 mA AC
 Current in conductor:
 $60 \text{ mA} \times 1,000 / 10 = 6,000 \text{ mA} = 6 \text{ A}$

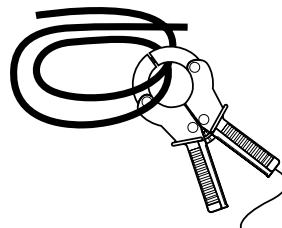

Figure 9

When the clamp is placed around two conductors with different polarities, the resulting reading will be the difference between the two currents. If the currents are the same, the reading will be zero (figure 10).

When a reading other than zero is obtained, the reading is the amount of leakage current on the load.

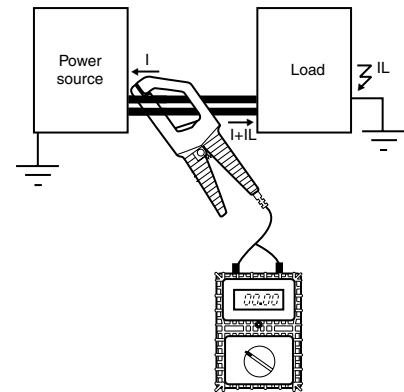

Figure 10

To measure low currents or leakage, you need a clamp which will measure low values, such as the model B102 or C173.

However, earth leakage currents may also be measured directly with the simple model (figure 11).

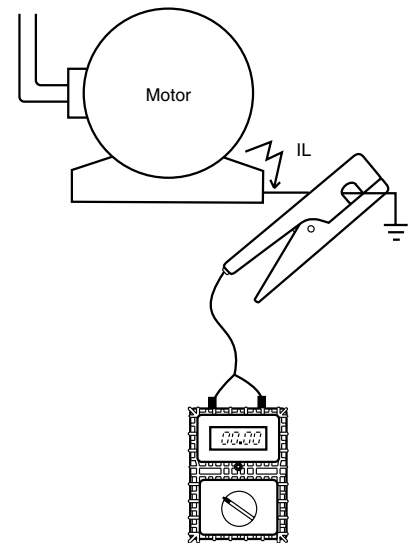

Figure 11

Example: figure 11

MINI 05

Ratio: 1 mV AC/mA AC
 DMM: set to 200 mA AC range
 DMM reading: 10 mV AC
 Leakage current: 10 mA AC

SELECTING A CURRENT PROBE

Answering the following questions will help you to select the appropriate clamp for your applications:

- 1- Determine if you are measuring AC or DC (DC current clamps are categorized as AC/DC because they measure both).
- 2- What is the the maximum current you will measure, and what is the minimum current you will measure? Check that the accuracy at low levels is appropriate, or select a low-current measurement clamp.

Most clamps perform with greater accuracy at the upper end of their range. Several clamps are designed to measure very low DC or AC.

3- What size conductor will you clamp onto? This parameter determines the clamp jaw size needed.

4- What type of clamp output do you need or can you work with (mA, mV, AC, DC, etc.)? Check the maximum receiver impedance to ensure that the clamp will perform to specifications.

Other factors you may want to consider:

What is the working voltage of the conductor to be measured ?

Chauvin Arnoux clamps must not be used above 600 volts (see specifications).



What type of termination do you need: sockets, banana leads or BNC leads ?

Will the probe be used for harmonics or power clamp ?

Look at the frequency specifications and phase shift specifications.

Measurement of AC current

Selection guide

Series	Model	Input						Output - Connections			Specific features					To order		
		Measuring range ⁽¹⁾						Current	Voltage	Lead + Ø 4 mm safety connectors ⁽³⁾	Ø 4 mm female sockets	BNC connector (coaxial)	Transformation ratio (input/output)	Output protected against voltage surges	Automatic DC voltage		Measurement of power (slight phase shift)	Bandwidth (frequency in Hz)
Very weak current	Weak current	Medium current	Strong current	AC	DC													
 Chap. 1	MINI 01	2...150 A			●		0.15 A AC		●			1000/1	●			48 Hz... 500 Hz	≤ 2.5%	P01105101Z
	MINI 02	50 mA...100 A			●		0.15 A AC		●			1000/1	●	●		48 Hz... 10 kHz	≤ 1%	P01105102Z
	MINI 03	1...100 A			●			0.1 V AC	●			1 A / 1 mV				48 Hz... 500 Hz	≤ 2%	P01105103Z
	MINI 05	5 mA...10 A			●			10 V AC	●			1 mA / 1 mV					≤ 3%	P01105105Z
	MINI 09	1...100 A			●			0.1 V AC	●			1 A / 1 mV					≤ 2%	P01105109Z
 Chap. 2	MN08	0.5...240 A			●		0.2 A AC		●	●		1000/1			40 Hz...10 kHz	≤ 1%	P01120401	
	MN09	0.5...240 A			●		0.2 A AC		●			1000/1				≤ 1%	P01120402	
	MN010	0.5...240 A			●		0.2 A AC		●	●		1000/1	●			≤ 2%	P01120403	
	MN011	0.5...240 A			●		0.2 A AC		●			1000/1	●			≤ 2%	P01120404	
	MN012	0.5...240 A			●			2 V AC	●	●		1 A / 10 mV				≤ 1%	P01120405	
	MN013	0.5 A...240 A			●			2 V AC	●			1 A / 10 mV				≤ 1%	P01120406	
	MN014	0.5 A...240 A			●			0.2 V AC	●	●		1 A / 1 mV				≤ 1%	P01120416	
	MN015	0.5 A...240 A			●			0.2 V AC	●			1 A / 1 mV				≤ 1%	P01120417	
	MN021	0.1 A...240 A			●		0.2 A AC		●			1000/1	●			≤ 2%	P01120418	
	MN023	0.1 A...240 A			●			2 V AC	●			1 A / 10 mV				≤ 1.5%	P01120419	
	MN038	0.1 A...24 A			●			2 V AC		●		1 A / 100 mV				≤ 1%	P01120407	
	MN039	0.5 A...240 A			●			2 V AC				1 A / 10 mV				≤ 1%	P01120408	
		0.1 A...24 A			●			2 V AC				1 A / 100 mV				≤ 2%	P01120409	
	MN060	0.5 A...600 Apeak			●			2 V AC			●	1 A / 10 mV				≤ 1.5%	P01120409	
		10 mA...12 A			●			1 V AC	●			1 A / 100 mV				≤ 1%	P01120420	
	MN073	10 mA...2.4 A			●			2 V AC	●			1 mA / 1 mV				≤ 1%	P01120421	
100 mA...240 A			●			2 V AC	●			1 A / 10 mV			≤ 2%	P01120410				
MN088	0.5 A...240 A			●			20 V DC ⁽²⁾	●	●		1 A / 100 mV			≤ 2%	P01120410			
MN089	0.5 A...240 A			●			20 V DC ⁽²⁾	●			1 A / 100 mV			≤ 2%	P01120415			
 Chap. 3	Y1N	4 A...600 A			●		0.5 A AC		●			1000/1	●		48 Hz...1 kHz	≤ 3%	P01120001A	
	Y2N	4 A...600 A			●		0.5 A AC		●			1000/1	●			≤ 1%	P01120028A	
	Y3N	4 A...600 A			●		5 A AC		●			100/1				≤ 3%	P01120029A	
	Y4N	4 A...600 A			●			0.5 V DC ⁽²⁾	●			500 A / 0.5 V				≤ 1%	P01120005A	
	Y7N	1 A...1200 Apeak			●			1 V AC		●		1 A / 1 mV				≤ 2%	P01120075	

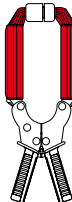

(1) The upper value corresponds to 120 % of the maximum rated value (2) Reformating of AC signal by diodes (3) Lead + electronic unit with Ø 4 mm safety connectors, centre distance 19 mm, for K and AmpFLEX™ series

Series	Model	Input						Output - Connections					Specific features						To order	
		Measuring range ⁽¹⁾						Current	Voltage	Lead + Ø 4 mm safety connectors ⁽³⁾	Ø 4 mm female sockets	BNC connector (coaxial)	Transformation ratio (input/output)	Output protected against voltage surges	Automatic DC voltage	Measurement of power (slight phase shift)	Bandwidth (frequency in Hz)	Typical accuracy		
		Very weak current	Weak current	Medium current	Strong current	AC	DC													
 Chap. 4	C100	0.1 A...1200 A				●		1 A AC		●			1000/1				30 Hz...10 kHz	≤ 0.5%	P01120301	
	C102	0.1 A...1200 A				●		1 A AC		●			1000/1	●				≤ 0.5%	P01120302	
	C103	0.1 A...1200 A				●		1 A AC		●			1000/1	●				≤ 0.5%	P01120303	
	C106	0.1 A...1200 A				●			1 V AC	●			1 A / 1 mV					≤ 0.5%	P01120304	
	C107	0.1 A...1200 A				●			1 V AC	●			1 A / 1 mV					≤ 0.5%	P01120305	
	C112	1 mA...1200 A				●		1 A AC		●			1000/1	●	●			≤ 0.3%	P01120314	
	C113	1 mA...1200 A				●		1 A AC		●			1000/1	●	●			≤ 0.3%	P01120315	
	C116	1 mA...1200 A				●			1 V AC	●			1 A / 1 mV		●			≤ 0.3%	P01120316	
	C117	1 mA...1200 A				●			1 V AC	●			1 A / 1 mV		●			≤ 0.3%	P01120317	
	C122	1 A...1200 A				●		5 A AC		●			1000/5	●				≤ 1%	P01120306	
	C148	1 A...300 A 1 A...600 A 1 A...1200 A				●		5 A AC		●			250/5 500/5 1000/5	●				48 Hz...1 kHz	≤ 2% ≤ 1% ≤ 1%	P01120307
	C160	0.1 A...30 A peak 0.1 A...300 A peak 1 A...2000 A peak				●			3 V peak 3 V peak 2 V peak		●		10 A / 1 V 100 A / 1 V 1000 A / 1 V					10 Hz ...100 kHz	≤ 3% ≤ 2% ≤ 1%	P01120308
C173	1 mA...1.2 A 0,01 A...12 A 0.1 A...120 A 1 A...1200 A				●			1 V AC	●			1 A / 1 V 10 A / 1 V 100 A / 1 V 1000 A / 1 V				10 Hz...3 kHz	≤ 0.7% ≤ 0.5% ≤ 0.3% ≤ 0.2%	P01120309		
 Chap. 5	D30N	1 A...3600 A				●		1 A AC		●			3000/1	●	●	30 Hz...5 kHz	≤ 0.5%	P01120049A		
	D30CN	1 A...3600 A				●		1 A AC		●			3000/1	●	●		≤ 0.5%	P01120064		
	D31N	1 A...600 A 1 A...1200 A 1 A...1800 A				●		1 A AC		●			500/1 1000/1 1500/1	●			30 Hz...1.5 kHz	≤ 3% ≤ 1% ≤ 0.5%	P01120050A	
	D32N	1 A...1200 A 1 A...2400 A 1 A...3600 A				●		1 A AC		●			1000/1 2000/1 3000/1	●	●		30 Hz...1 kHz	≤ 1% ≤ 0.5% ≤ 0.5%	P01120051A	
	D33N	1 A...3600 A				●		5 A AC		●			3000/5				30 Hz...5 kHz	≤ 1%	P01120052A	
	D34N	1 A...600 A 1 A...1200 A 1 A...1800 A				●		5 A AC		●			500/5 1000/5 1500/5				30 Hz...1.5 kHz	≤ 3% ≤ 1% ≤ 0.5%	P01120053A	
	D35N	1 A...1200 A 1 A...2400 A 1 A...3600 A				●		5 A AC		●			1000/5 2000/5 3000/5	●				≤ 1% ≤ 0.5% ≤ 0.5%	P01120054A	
	D36N	1 A...3600 A				●		3 A AC		●			3000/3	●	●			≤ 0.5%	P01120055A	
	D37N	0.1 A...36 A 1 A...360 A 1 A...3600 A				●			3 V AC	●			30 A/3 V 300 A/3 V 3000 A/3 V				30 Hz...5 kHz	≤ 2%	P01120056A	
	D38N	1 A...90 A peak 1 A...900 A peak 1 A...9000 A peak				●			1 V AC		●		1 A / 10 mV 1 A / 1 mV 1 A / 0.1 mV				30 Hz...50 kHz	≤ 2%	P01120057A	
Chap. 6	B102	500 µA...4 A 0.5 A...400 A				●			4 V AC 0.4 V AC	●			1 mA / 1 mV 1 A / 1 mV			10 Hz...1 kHz	≤ 0.5% ≤ 0.35%	P01120083		

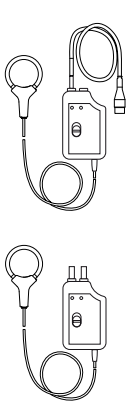
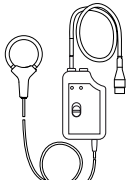
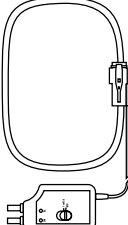
(1) The upper value corresponds to 120 % of the maximum rated value
 (3) Lead + electronic unit with Ø 4 mm safety connectors, centre distance 19 mm, for K and AmpFLEX™ series

Series	Model	Input						Output - Connections			Specific features						To order		
		Measuring range ⁽¹⁾						Current	Voltage	Lead + Ø 4 mm safety connectors ⁽³⁾	Ø 4 mm female sockets	BNC connector (coaxial)	Transformation ratio (input/output)	Output protected against voltage surges	Automatic DC voltage	Measurement of power (slight phase shift)		Bandwidth (frequency in Hz)	Typical accuracy
Very weak current	Weak current	Medium current	Strong current	AC	DC														
 <p>Chap. 7</p>	MA100 30-300/3 (17 cm)	0.5 A...30 A	0.5 A...300 A					3 V AC	●			100 mV/A 10 mV/A					5 kHz...20 kHz	≤ 1%	P01120560
	MA100 30-300 /3 (17 cm)	0.5 A...30 A	0.5 A...300 A					3 V AC		●		100 mV/A 10 mV/A						≤ 1%	P01120563
	MA100 300-3000/3 (25 cm)	0.5 A...300 A	0.5 A...3000 A					3 V AC	●			10 mV/A 1 mV/A						≤ 1%	P01120561
	MA100 300-3000/3 (25 cm)	0.5 A...300 A	0.5 A...3000 A					3 V AC			●	10 mV/A 1 mV/A						≤ 1%	P01120564
	MA100 300-3000 /3 (35 cm)	0.5 A...300 A	0.5 A...3000 A					3 V AC	●			10 mV/A 1 mV/A						≤ 1%	P01120562
	MA100 300-3000/3 (35 cm)	0.5 A...300 A	0.5 A...3000 A					3 V AC			●	10 mV/A 1 mV/A						≤ 1%	P01120565
 <p>Chap. 7</p>	MA200 30-300/3 (17 cm)	0.5 A...45 Apeak	0.5 A...450 Apeak					4.5 V peak			●	100 mV/A 10 mV/A					5 Hz...1 MHz	≤ 1% + 0.3 A	P01120570
	MA200 30-300/3 (25 cm)	0.5 A...45 Apeak	0.5 A...450 Apeak					4.5 V peak			●	100 mV/A 10 mV/A						≤ 1% + 0.3 A	P01120571
	MA200 3000 /3 (35 cm)	5 A...4500 Apeak						4.5 V peak			●	1 mV/A						≤ 1% + 0.3 A	P01120572
 <p>Chap. 8</p>	A100 20-200/2 (45 cm)	0.5 A...20 A	0.5 A...200 A					2 V AC	●			1 A / 100 mV 1 A / 10 mV					10 kHz...20 kHz	≤ 1%	P01120503
	A100 2000/2 (45 cm)		0.5 A...2000 A					2 V AC	●			1 A / 1 mV						≤ 1%	P01120501
	A100 2000/2 (80 cm)		0.5 A...2000 A					2 V AC	●			1 A / 1 mV						≤ 1%	P01120502
	A100 0.2-2 k/2 (45 cm)	0.5 A...200 A	0.5 A...2000 A					2 V AC	●			1 A / 10 mV 1 A / 1 mV						≤ 1%	P01120504
	A100 0.2-2 k/2 (80 cm)	0.5 A...200 A	0.5 A...2000 A					2 V AC	●			1 A / 10 mV 1 A / 1 mV						≤ 1%	P01120505
	A100 0.3-3 k/3 (45 cm)	0.5 A...300 A	0.5 A...3000 A					3 V AC	●			1 A / 10 mV 1 A / 1 mV						≤ 1%	P01120506
	A100 0.3-3 k/3 (80 cm)	0.5 A...300 A	0.5 A...3000 A					3 V AC	●			1 A / 10 mV 1 A / 1 mV						≤ 1%	P01120507
	A100 0.3-3 k/3 (120 cm)	0.5 A...300 A	0.5 A...3000 A					3 V AC	●			1 A / 10 mV 1 A / 1 mV						≤ 1%	P01120508
	A100 1-10 k/1 (120 cm)	0.5 A...1000 A	0.5 A...10000 A					1 V AC	●			1 A / 1 mV 1 A / 0.1 mV						≤ 1%	P01120509

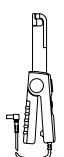

(1) The upper value corresponds to 120 % of the maximum rated value
 (3) Lead + electronic unit with Ø 4 mm safety connectors, centre distance 19 mm, for K and AmpFLEX™ series

Series	Model	Input				Output - Connections				Specific features					To order	
		Measuring range ⁽¹⁾				Current	Voltage	Lead + Ø 4 mm safety connectors ⁽³⁾	Ø 4 mm female sockets	BNC connector (coaxial)	Transformation ratio (input/output)	Output protected against voltage surges	Automatic DC voltage	Measurement of power (slight phase shift)		Bandwidth (frequency in Hz)
Very weak current	Weak current	Medium current	Strong current	AC	DC											
Chap. 9	 K1	1 mA...4.5 A DC 1 mA...3 A RMS 1 mA...4.5 Apeak				●	●	●			1 mA / 1 mV			DC...2 kHz	≤ 1%	P01120067A
	K2	100 µA...450 mA DC 100 µA...300 mA RMS 100 µA...450 mApeak				●	●	●			1 mA / 10 mV			DC...1.5 kHz	≤ 1%	P01120074A
Chap. 10		E1N	0,05 A...2 A DC 0,05 A...1.5 A AC 0.5 A...150 A AC/DC		●	●	●			1 A / 1 V 1 A / 1 mV			DC... 2 kHz DC... 8 kHz	≤ 2% ≤ 1.5%	P01120030A	
		E3N	0,05 A...10 Apeak 1 A...100 Apeak		●	●		●		1 A / 100 mV 1 A / 10 mV			DC...100 kHz	≤ 3% ≤ 4%	P01120043A	
		E6N	5 mA...2 A DC 5 mA...1.5 A AC 20 mA...80 A AC/DC		●	●	●			1 A / 1 V 1 A / 10 mV			DC... 2 kHz DC... 8 kHz	≤ 2% ≤ 4%	P01120040A	
Chap. 11		PAC10	0.5 A...400 A AC 0.5 A...600 A DC		●	●	●			1 A / 1 mV			DC...5 kHz	≤ 2%	P01120070	
		PAC11	0.2 A...40 A AC 0.4 A...60 A DC 0.5 A...400 A AC 0.5 A...600 A DC		●	●	●			1 A / 10 mV 1 A / 1 mV	●		DC...10 kHz	≤ 1.5% ≤ 2%	P01120068	
		PAC12	0.2 A...60 Apeak 0.4 A...60 A DC 0.5 A...600 Apeak 0.5 A...600 A DC		●	●	●			1 A / 10 mV 1 A / 1 mV	●		DC...10 kHz	≤ 1.5% ≤ 2%	P01120072	
Chap. 11		PAC20	0.5 A...1000 A AC 0.5 A...1400 A DC		●	●	●			1 A / 1 mV			DC...5 kHz	≤ 2%	P01120071	
		PAC21	0.2 A...100 A AC 0.4 A...150 A DC 0.5 A...1000 A AC 0.5 A...1400 A DC		●	●	●			1 A / 10 mV 1 A / 1 mV	●		DC...10 kHz	≤ 1.5% ≤ 2.5%	P01120069	
		PAC22	0.2 A...150 Apeak 0.4 A...150 A DC 0.5 A...1400 Apeak 0.5 A...1400 A DC		●	●	●			1 A / 10 mV 1 A / 1 mV	●		DC...10 kHz	≤ 1.5% ≤ 2.5%	P01120073	







(1) The upper value corresponds to 120 % of the maximum rated value
 (3) Lead + electronic unit with Ø 4 mm safety connectors, centre distance 19 mm, for K and AmpFLEX™ series

Series	Model	Input						Output - Connections			Specific features					To order
		Measuring range ⁽¹⁾						Current	Voltage	Lead + Ø 4 mm safety connectors ⁽³⁾	Ø 4 mm female sockets	BNC connector (coaxial)	Transformation ratio (input/output)	Output protected against voltage surges	Automatic DC voltage	
Very weak current	Weak current	Medium current	Strong current	AC	DC											

ea age current measurement

 Chap. 2	MN73	10 mA...2,4 A 100 mA...240 A					●				2 V AC 2 V AC	●			1 A / 1000 mV 1 A / 10 mV			40 Hz...10 kHz	≤ 1% ≤ 2%	P01120421
 Chap. 4	C173	1 mA...1.2 A 0,01 A...12 A 0.1 A...120 A 1 A...1200 A					●				1 V AC	●			1 A / 1 V 10 A / 1 V 100 A / 1 V 1000 A / 1 V			10 Hz...3 kHz	≤ 0.7% ≤ 0.3% ≤ 0.5% ≤ 0.2%	P01120309
 Chap. 6	B102	500 µA...4 A 0.5 A...400 A					●				4 V AC 0.4 V AC	●			1 mA / 1 mV 1 A / 1 mV	●		10 Hz...1 kHz	≤ 0.5% ≤ 0.35%	P01120083

ea surement on oscilloscope

 Chap. 2	MN60	0.1 A...60 Apeak 0.5 A...600 Apeak					●				2 V AC 2 V AC	●			1 A / 100 mV 1 A / 10 mV			40 Hz...40 kHz	≤ 2% ≤ 1.5%	P01120409
 Chap. 3	Y7N	1 A...1200 Apeak					●				1 V AC	●			1 mA / 1 mV			5 Hz...10 kHz	≤ 2%	P01120075
 Chap. 4	C160	0.1 A...30 Apeak 1 A...300 Apeak 1 A...2000 Apeak					●				3 V peak 3 V peak 2 V peak	●			10 A / 1 V 100 A / 1 V 1000 A / 1 V			10 Hz...100 kHz	≤ 3% ≤ 2% ≤ 1%	P01120308
 Chap. 5	D38N	1 A...90 Apeak 1 A...900 Apeak 1 A...9000 Apeak					●				1 V AC	●			1 A / 10 V 1 A / 1 mV 1 A / 0.1 mV			30 Hz...50 kHz	≤ 2%	P01120057A
 Chap. 10	E3N	0,05 A...10 Apeak 1 A...100 Apeak					●	●			1 V peak	●			1 A / 10 mV 1 A / 1 mV			DC...100 kHz	≤ 3% ≤ 4%	P01120043A
 Chap. 7	MA 200	MA200 30-300/3 (17 cm)	0.5 A...45 Apeak 0.5 A...450 Apeak				●				4.5 V peak	●			100 mV/A 10 mV/A				≤ 1% + 0.3 A	P01120570
		MA200 30-300/3 (25 cm)	0.5 A...45 Apeak 0.5 A...450 Apeak				●				4.5 V peak	●			100 mV/A 10 mV/A			5 Hz...1 MHz	≤ 1% + 0.3 A	P01120571
		MA200 3000 /3 (35 cm)	5 A...4500 Apeak				●				4.5 V peak	●			1 mV/A				≤ 1% + 0.3 A	P01120572
 Chap. 11	PAC12	0.2 A...60 Apeak 0.4 A...60 A DC 0.5 A...600 Apeak 0.5 A...600 A DC					●	●			600 mV AC/DC	●			1 A / 10 mV 1 A / 1 mV	●		DC...10 kHz	≤ 1.5% ≤ 2%	P01120072
 Chap. 11	PAC22	0.2 A...150 Apeak 0.4 A...150 A DC 0.5 A...1400 Apeak 0.5 A...1400 A DC					●	●			1.4 V AC/DC	●			1 A / 10 mV 1 A / 1 mV	●		DC...10 kHz	≤ 1.5% ≤ 2.5%	P01120073

ea surement of process current

 Chap. 9	K1	1 mA...4.5 A DC 1 mA...3 A RMS 1 mA...4.5 Apeak					●	●			4.5 V DC 3 V RMS 4.5 V peak	●			1 mA / 1 mV			DC...2 kHz	≤ 1%	P01120067A
	K2	100 µA...450 mA DC 100 µA...300 mA RMS 100 µA...450 mApeak					●	●			4.5 V DC 3 V RMS 4.5 V peak	●			1 mA / 10 mV			DC...1.5 kHz	≤ 1%	P01120074A

ea surement on secondary winding of current transformers

 Chap. 2	MN71	10 mA...12 A					●				1 V AC	●			1 A / 100 mV			40 Hz...10 kHz	≤ 1%	P01120420
--	------	--------------	--	--	--	--	---	--	--	--	--------	---	--	--	--------------	--	--	----------------	------	-----------

(1) The upper value corresponds to 120 % of the maximum rated value
(3) Lead + electronic unit with Ø 4 mm safety connectors, centre distance 19 mm, for K and AmpFLEX™ series



MINI series

Small, compact and particularly resistant, this range of miniature clamps is designed for measurements from a few milli-amperes to 150 A AC. Their shape makes them very practical in confined spaces, such as circuit-breaker boards, control panels or control boxes. They are ideal for use with multimeters.

There are two types of MINI clamps.

The first type operates like a traditional current transformer and provides a current output (mA) which can be used with multimeters, loggers or instruments with current calibres.

The second provides a voltage output proportional to the current measured.

This voltage output enables instruments with AC voltage calibres to display or store current values.

There is also a model with a DC voltage output.

The MINI clamps give True RMS results when used with a True RMS instrument.

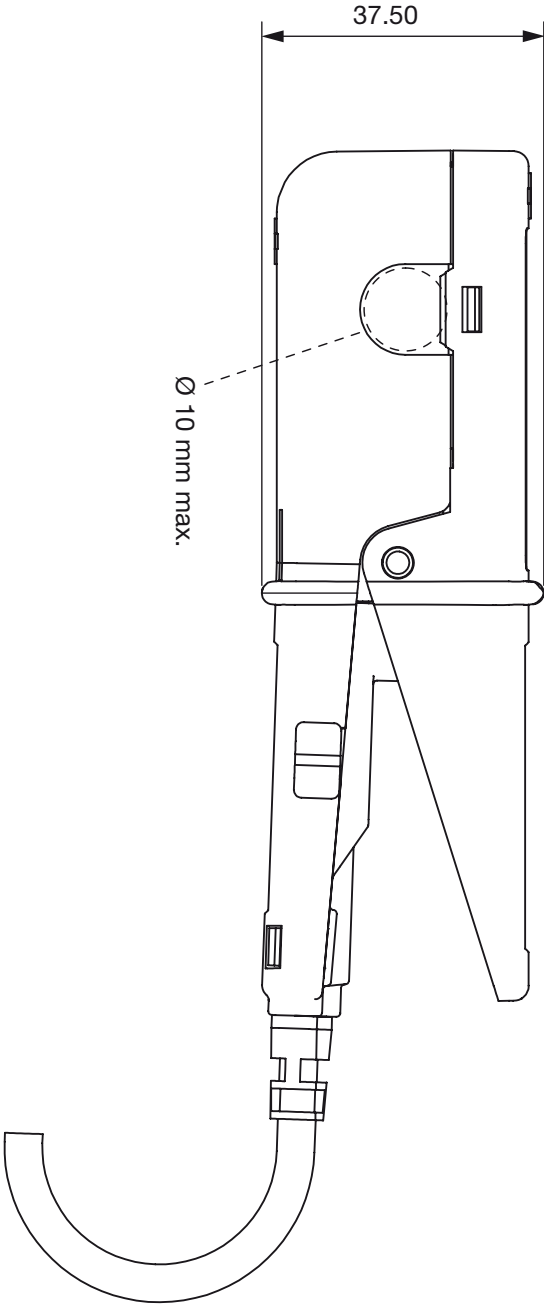
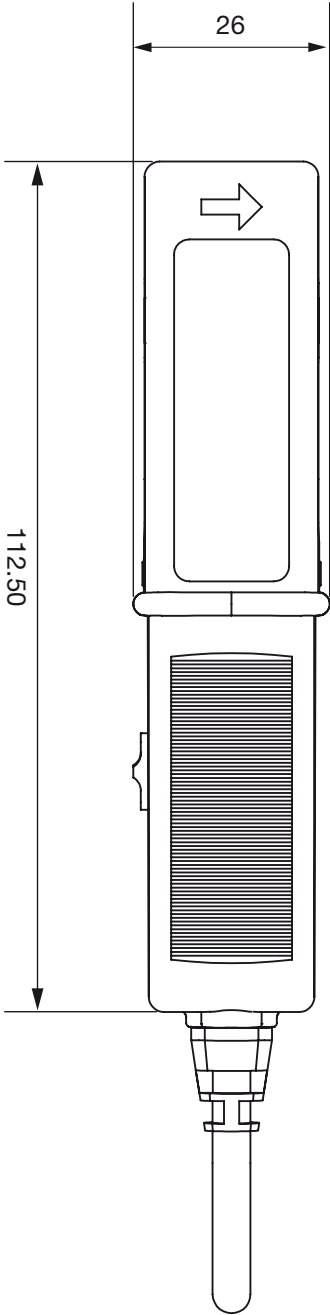

Current clamp for AC current

odel Inl “

MINI series

Calibre	150 A AC
Sensitivity	1 mA/A (1000/1)

Description

Small and compact, the MINI 01 current clamp is the ideal complement for any multimeter to measure AC currents in low-power tertiary or industrial applications. If there is a current in the conductor clamped, the MINI 01 clamp is protected against overvoltages during disconnection from the measurement instrument.



Main specifications ⁽¹⁾

Calibre	150 A
Measurement range	2 A...150 A
Accuracy in %	≤ 2.5 % + 0.15 A (load 1 Ω) ≤ 3 % + 0.15 A (load 10 Ω)
Phase shift	not specified
Output signal	1 mA AC/A AC (1000/1) (150 mA for 150 A)

Output:

Double-insulated cable 1.5 m long, terminated by 2 insulated elbowed male banana connectors Ø 4 mm

Bandwidth:

48 Hz...500 Hz

Clamping capacity:

Cable Ø max 10 mm

Electrical specifications

Load impedance:

≤ 10 Ω

Maximum currents:

I < 150 A permanent from 48 Hz...500 Hz

Influence of temperature:

≤ 0.2 % per 10 °K

Influence of adjacent conductor:

≤ 2 mA/A at 50 Hz

Influence of conductor position in jaws:

≤ 0.1 % at 50/60 Hz

Influence of frequency:

≤ 2 % from 65 Hz to 500 Hz

Maximum output voltage (secondary open):

30 V

Mechanical specifications

Operating temperature:

-10 °C to +50 °C

Storage temperature:

-40 °C to +80 °C

Relative humidity for operation:

From 0 to 85 % RH with a linear decrease above 35 °C

Operating altitude:

0 to 2,000 m

Casing protection rating (leakproofing):

IP40 ⁽²⁾ (EN 60529 Ed. 1992)

Drop test:

1.5 m (IEC 68-2-32)

Shock resistance:

100 g / 6 ms / half-period (IEC 68-2-27)

Vibration resistance ⁽³⁾:

5-15 Hz (1.5 mm), 15-25 Hz (1 mm),
25-55 Hz (0.25 mm) (IEC 68-2-6)

Self-extinguishing capability:

casing UL94 V2

Dimensions:

130 x 37 x 25 mm

Weight:

approx. 180 g

Colour:

Black casing

Safety specifications

Electrical safety:

Instrument with double insulation or reinforced insulation between the primary, the secondary and the grippable part located under the guard as per EN 61010-1 Ed. 2:2001, EN 61010-2-031 Ed. 2002 & EN 61010-2-032 Ed. 2003

- 600 V category III, pollution degree 2
- 300 V category IV, pollution degree 2

Electromagnetic compatibility:

CE-certified equipment compliant with standard EN 61326-1 (Ed.97) + A1 (Ed.98) + A2 (Ed.01)

- Emission: stipulations for class B equipment (domestic use).
- Immunity: stipulations for equipment used intermittently on industrial sites.

(1) Conditions of reference: 23 °C ± 3 °K, 20 °C to 75 % RH, sinusoidal signal with frequency of 48 Hz to 65 Hz, distortion factor < 1 % with no DC component, external DC magnetic field < 40 A/m, no external AC magnetic field, no external conductor with circulating current, conductor centred for measurement, measurement instrument load impedance ≤ 10 Ω.

(2) With clamp closed.

(3) Vibrations expressed in mm peak, scanning of 1 octave/minute for 10 minutes on 3 axes.

To order	Reference
AC current clamp model MINI 01 with operating manual	P01105101Z

Current clamp for AC current

odel Inl ”

MINI series

Calibre	100 AAC
Sensitivity	1 mA/A (1000/1)

Description

The MINI 02 current clamp, whose jaws are equipped with a high-performance magnetic material and a double coil, offers excellent linearity and improved performance.

Small and compact, it is ideal for measuring AC currents in low-power tertiary or industrial applications.

If a current is present in the conductor being clamped, the MINI 02 clamp is protected against voltage surges when it is disconnected from the measurement instrument.



Main specifications ⁽¹⁾

Calibre	100 A
Measurement range	50 mA .. 100 A (load 1 Ω) 50 mA .. 90 A (load 10 Ω)
Accuracy in % (48 Hz to 10 kHz)	≤ 1 % + 0.02 A (load 1 Ω) ≤ 1.5 % + 0.01 A (load 10 Ω)
Phase shift (50 Hz to 60 Hz)	≤ 3° (load 1 Ω) ≤ 6° (load 10 Ω)
Output signal	1 mA AC/A AC (1000/1) (100 mA for 100 A)

Output:

Double-insulated cable 1.5 m long, terminated by 2 insulated elbowed male banana connectors Ø 4 mm

Bandwidth:

48 Hz ... 10 000 Hz

Clamping capacity:

Cable Ø max 10 mm

Electrical specifications

Load impedance:

≤ 100 Ω

Influence of load impedance:

see curves

Maximum currents:

I < 100 A permanent from 48 Hz ... 10,000 Hz

Influence of temperature:

≤ 0.2 % per 10 °K

Influence of adjacent conductor:

≤ 2 mA/A at 50 Hz

Influence of conductor position in jaws:

≤ 0.1 % at 50/60 Hz

Influence of frequency:

≤ 2 % from 65 Hz to 500 Hz

Maximum output voltage

(secondary open):

≤ 30 V

Mechanical specifications

Operating temperature:

-10 °C to +50 °C

Storage temperature:

-40 °C to +80 °C

Relative humidity for operation:

From 0 to 85 % RH with a linear decrease above 35 °C

Operating altitude:

0 to 2,000 m

Casing protection rating (leakproofing):

IP40 ⁽²⁾ (EN 60529 Ed. 1992)

Drop test:

1.5 m (IEC 68-2-32)

Shock resistance:

100 g / 6 ms / half-period (IEC 68-2-27)

Vibration resistance ⁽³⁾:

5-15 Hz (1.5 mm), 15-25 Hz (1 mm),
25-55 Hz (0.25 mm) (IEC 68-2-6)

Self-extinguishing capability:

Casing UL94 V2

Dimensions:

130 x 37 x 25 mm

Weight:

Approx. 180 g

Colour:

Black casing

Safety specifications

Electrical safety:

Instrument with double insulation or reinforced insulation between the primary, the secondary and the grippable part located under the guard as per EN 61010-1 Ed. 2:2001, EN 61010-2-031 Ed. 2002 & EN 61010-2-032 Ed. 2003

- 600 V category III, pollution degree 2

- 300 V category IV, pollution degree 2

Electromagnetic compatibility:

CE-certified equipment compliant with standard EN 61326-1 (Ed.97) + A1 (Ed.98) + A2 (Ed.01)

- Emission: stipulations for class B equipment (domestic use).

- Immunity: stipulations for equipment used intermittently on industrial sites.

Current clamp for AC current model IN1

MINI series

Curves at 50 Hz

Typical linearity error for loads of 1, 10, 30 and 100 Ω

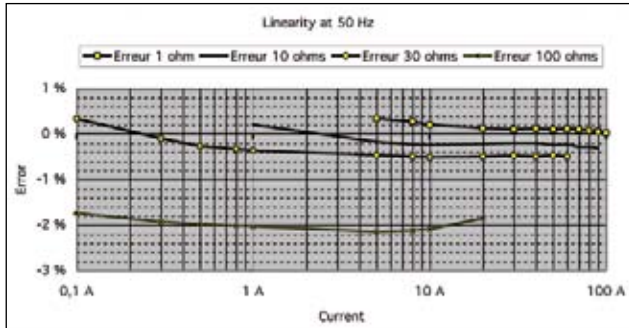

Typical phase shift for loads of 1, 10, 30 and 100 Ω

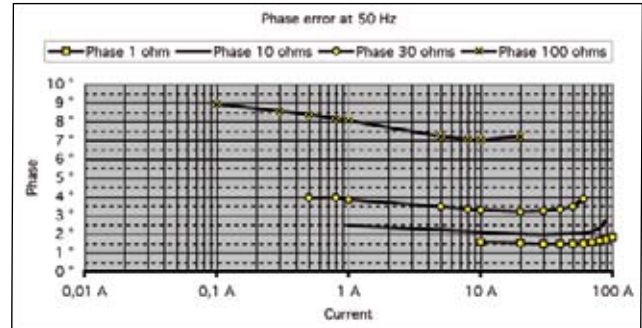

Frequency response at 10 A

Typical linearity error for loads of 1, 10, 30 and 100 Ω

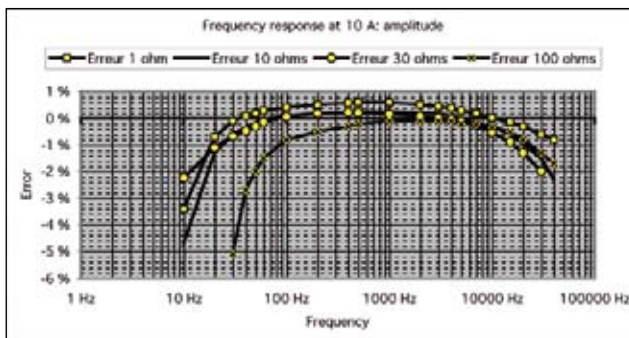

Typical phase shift for loads of 1, 10, 30 and 100 Ω

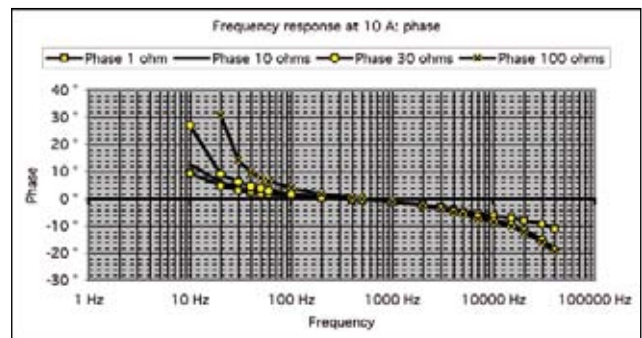

- (1) Conditions of reference: 23 °C ± 3 °K, 20 °C to 75 % RH, sinusoidal signal with frequency of 48 Hz at 10 kHz, distortion factor < 1 % with no DC component, external DC magnetic field < 40 A/m, no external AC magnetic field, no external conductor with circulating current, conductor centred for measurement, measurement instrument load impedance ≤ 10 Ω.
- (2) With clamp closed.
- (3) Vibrations expressed in mm peak, scanning of 1 octave/minute for 10 minutes on 3 axes.

To order	Reference
AC current clamp model MINI 02 with operating manual	P01105102Z

Current clamp for AC current

odel Inl

MINI series

Calibre	100 AAC
Sensitivity	1 mV/A

■ Description

Small and compact, the MINI 03 current clamp is the ideal complement for any multimeter to measure AC currents in low-power tertiary or industrial applications. When used with an AC voltmeter, it allows you to directly read the current measured on the voltmeter.



■ Main specifications ⁽¹⁾

Calibre	100 A
Measurement range	1 A...100 A
Accuracy in %	≤ 2 % + 50 mA
Phase shift	not specified
Output signal	1 mVAC/A AC (100 mV for 100 A)

Output:

Double-insulated cable 1.5 m long, terminated by 2 insulated elbowed male banana connectors Ø 4 mm

Bandwidth:

48 Hz...500 Hz

Clamping capacity:

Cable Ø max 10 mm

■ Electrical specifications

Maximum currents:

I < 150 A permanent from 48 Hz...500 Hz

Influence of temperature:

≤ 0.2 % per 10 °K

Influence of adjacent conductor:

≤ 2 mA/A at 50 Hz

Influence of conductor position in jaws:

≤ 0.1 % at 50/60 Hz

Influence of frequency:

≤ 1 % from 65 Hz to 500 Hz

■ Mechanical specifications

Operating temperature:

-10 °C to +50 °C

Storage temperature:

-40 °C to +80 °C

Relative humidity for operation:

from 0 to 85 % RH with a linear decrease above 35 °C

Operating altitude:

0 to 2,000 m

Casing protection rating (leakproofing):

IP40 ⁽²⁾ (EN 60529 Ed. 1992)

Drop test:

1.5 m (IEC 68-2-32)

Shock resistance:

100 g / 6 ms / half-period (IEC 68-2-27)

Vibration resistance ⁽³⁾:

5-15 Hz (1.5 mm), 15-25 Hz (1 mm),

25-55 Hz (0.25 mm) (IEC 68-2-6)

Self-extinguishing capability:

Casing UL94 V2

Dimensions:

130 x 37 x 25 mm

Weight:

Approx. 180 g

Colour:

Black casing

■ Safety specifications

Electrical safety:

Instrument with double insulation or reinforced insulation between the primary, the secondary and the grippable part located under the guard as per EN 61010-1 Ed. 2:2001, EN 61010-2-031 Ed. 2002 & EN 61010-2-032 Ed. 2003

- 600 V category III, pollution degree 2

- 300 V category IV, pollution degree 2

Electromagnetic compatibility:

CE-certified equipment compliant with standard EN 61326-1 (Ed. 97) + A1 (Ed. 98) + A2 (Ed. 01)

- Emission: stipulations for class B equipment (domestic use).

- Immunity: stipulations for equipment used intermittently on industrial sites.

(1) Conditions of reference: 23 °C ± 3 °K, 20 °C to 75 % RH, sinusoidal signal with frequency of 48 Hz to 65 Hz, distortion factor < 1 % with no DC component, external DC magnetic field < 40 A/m, no external AC magnetic field, no external conductor with circulating current, conductor centred for measurement, measurement instrument load impedance ≥ 10 kΩ.

(2) With clamp closed.

(3) Vibrations expressed in mm peak, scanning of 1 octave/minute for 10 minutes on 3 axes.

To order	Reference
AC current clamp model MINI 03 with operating manual	P01105103Z

Current clamp for AC current

odel InI

MINI series

Calibre	10 A AC	100 A AC
Sensitivity	1 mV/mA	1 mV/A

Description

Small and compact, the MINI 05 current clamp is the ideal complement for any multimeter to measure AC currents in low-power tertiary or industrial applications. With its 2 calibres, it offers excellent resolution for measuring AC currents from 5 mA to 100 A.



Main specifications ⁽¹⁾

Calibre	10 A	100 A
Measurement range	5 mA...10 A	1 A...100 A
Accuracy in %	≤ 3 % + 0.15 mA	≤ 2 % + 50 mA
Phase shift	not specified	
Output signal	1 mVAC/mAAC (10 V for 10 A)	1 mVAC/AAC (100 mV for 100 A)

Output:

Double-insulated cable 1.5 m long, terminated by 2 insulated elbowed male banana connectors Ø 4 mm

Bandwidth:

48 Hz...500 Hz

Clamping capacity:

Cable Ø max 10 mm

Electrical specifications

Maximum currents:

100 A calibre
I < 150 A permanent from 48 Hz...500 Hz

10 A calibre
I < 15 A permanent from 48 Hz...500 Hz

Influence of temperature:

≤ 0.2 % per 10 °K

Influence of adjacent conductor:

≤ 2 mA/A at 50 Hz

Influence of conductor position in jaws:

≤ 0.1 % at 50/60 Hz

Influence of frequency:

100 A calibre:
≤ 1 % from 65 Hz to 500 Hz

10 A calibre:
≤ 3 % from 65 Hz to 500 Hz

Mechanical specifications

Operating temperature:

-10 °C to +50 °C

Storage temperature:

-40 °C to +80 °C

Relative humidity for operation:

from 0 to 85 % RH with a linear decrease above 35 °C

Operating altitude:

0 to 2,000 m

Casing protection rating (leakproofing):

IP40 ⁽²⁾ (EN 60529 Ed. 1992)

Drop test:

1.5 m (IEC 68-2-32)

Shock resistance:

100 g / 6 ms / half-period (IEC 68-2-27)

Vibration resistance ⁽³⁾:

5-15 Hz (1.5 mm), 15-25 Hz (1 mm),
25-55 Hz (0.25 mm) (IEC 68-2-6)

Self-extinguishing capability:

casing UL94 V2

Dimensions:

130 x 37 x 25 mm

Weight:

Approx. 180 g

Colour:

Black casing

Safety specifications

Electrical safety:

Instrument with double insulation or reinforced insulation between the primary, the secondary and the grippable part located under the guard as per EN 61010-1 Ed. 2:2001, EN 61010-2-031 Ed. 2002 & EN 61010-2-032 Ed. 2003

- 600 V category III, pollution degree 2
- 300 V category IV, pollution degree 2

Electromagnetic compatibility:

CE-certified equipment compliant with standard EN 61326-1 (Ed. 97) + A1 (Ed. 98) + A2 (Ed. 01)

- Emission: stipulations for class B equipment (domestic use).
- Immunity: stipulations for equipment used intermittently on industrial sites.

(1) Conditions of reference: 23 °C ± 3 °K, 20 °C to 75 % RH, sinusoidal signal with frequency of 48 Hz to 65 Hz, distortion factor < 1 % with no DC component, external DC magnetic field < 40 A/m, no external AC magnetic field, no external conductor with circulating current, conductor centred for measurement, measurement instrument load impedance ≥ 1 MΩ (10 A calibre) & ≥ 10 kΩ (100 A calibre).

(2) With clamp closed.

(3) Vibrations expressed in mm peak, scanning of 1 octave/minute for 10 minutes on 3 axes.

To order	Reference
AC current clamp model MINI 05 with operating manual	P01105105Z

Current clamp for AC current

odel InI

MINI series

Calibre	150 AAC
Sensitivity	100 mVDC / A AC

Description

Small and compact, the MINI 09 current clamp is the ideal complement for any multimeter to measure AC currents in low-power tertiary or industrial applications. Its DC voltage output helps to overcome the low sensitivity of certain AC measurement instruments.

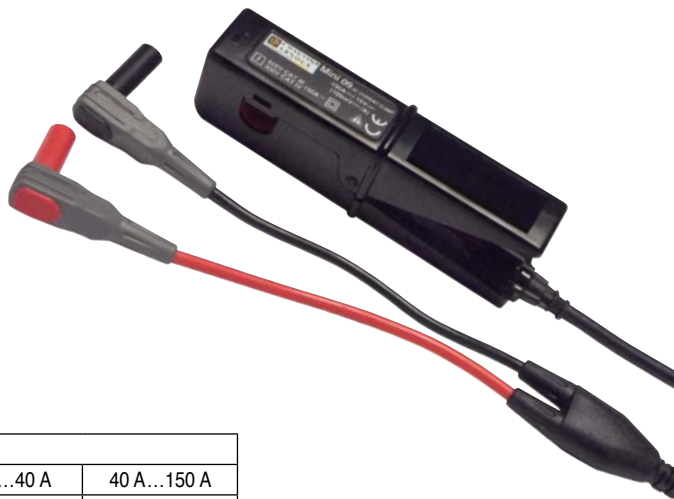

Main specifications ⁽¹⁾

Calibre	150 A			
Measurement range	1 A...5 A	5 A...15 A	15 A...40 A	40 A...150 A
Accuracy in %	≤ 10 % + 0.2 A	≤ 6 % + 0.2 A	≤ 3 % + 0.2 A	≤ 4 %
Phase shift	not specified			
Output signal	100 mVDC / A AC (15 VDC for 150 A)			

Output:

Double-insulated cable 1.5 m long, terminated by 2 insulated elbowed male banana connectors Ø 4 mm

Bandwidth:

48 Hz...500 Hz

Clamping capacity:

Cable Ø max 10 mm

Electrical specifications

Maximum currents:

I < 150 A permanent from 65 Hz...500 Hz

Influence of temperature:

≤ 0.2 % per 10 °K

Influence of adjacent conductor:

≤ 2 mA/A at 50 Hz

Influence of conductor position in jaws:

≤ 0.1 % at 50/60 Hz

Influence of frequency:

≤ 3 % from 65 Hz to 500 Hz

Mechanical specifications

Operating temperature:

-10 °C to +50 °C

Storage temperature:

-40 °C to +80 °C

Relative humidity for operation:

0 to 85 % RH decreasing linearly above 35 °C

Operating altitude:

0 to 2,000 m

Casing protection rating (leakproofing):

IP40 ⁽²⁾ (EN 60529 Ed. 1992)

Drop test:

1.5 m (IEC 68-2-32)

Shock resistance:

100 g / 6 ms / half-period (IEC 68-2-27)

Vibration resistance ⁽³⁾:

5-15 Hz (1.5 mm), 15-25 Hz (1 mm), 25-55 Hz (0.25 mm) (IEC 68-2-6)

Self-extinguishing capability:

Casing UL94 V2

Dimensions:

130 x 37 x 25 mm

Weight:

Approx. 180 g

Colour:

Black casing

Safety specifications

Electrical safety:

Instrument with double insulation or reinforced insulation between the primary, the secondary and the grippable part located under the guard as per EN 61010-1 Ed. 2:2001, EN 61010-2-031 Ed. 2002 & EN 61010-2-032 Ed. 2003
 - 600 V category III, pollution degree 2
 - 300 V category IV, pollution degree 2

Electromagnetic compatibility:

CE-certified equipment compliant with standard EN 61326-1 (Ed. 97) + A1 (Ed. 98) + A2 (Ed. 01)
 - Emission: stipulations for class B equipment (domestic use).
 - Immunity: stipulations for equipment used intermittently on industrial sites.

(1) Conditions of reference: 23 °C ± 3 °K, 20 % to 75 % RH, sinusoidal signal with frequency of 48 Hz to 65 Hz, distortion factor < 1 % with no DC component, external DC magnetic field < 40 A/m, no external AC magnetic field, no external conductor with circulating current, conductor centred for measurement, measurement instrument load impedance ≥ 50 kΩ.

(2) With clamp closed.

(3) Vibrations expressed in mm peak, scanning of 1 octave/minute for 10 minutes on 3 axes.

To order	Reference
AC current clamp model MINI 09 with operating manual	P01105109Z



MN series

These ergonomic mini-clamps are designed to make light work of measuring low and medium currents from 0.01 A to 240 AAC.

The shape of the jaws makes 'hooking' onto cables easy, even in areas of restrictive access. The jaws can grip conductors up to 20 mm in diameter.

Depending on the particular model, they have one or two calibres. The output is via either jack sockets or a lead with 4 mm Ø plugs, hence these clamps are compatible with all multimeters and testers on the market.

There are two types of MN series clamps available. The first kind operates as a current transformer (ratio 1000/1) and gives a current output (mA) for use with any tester with current calibres.

The second type gives a voltage output (DC or AC depending on the model) proportional to the measured current (1, 10, 100 or 1000 mV/A). This voltage output means that, even with testers without any current calibres, it is possible to measure currents by means of the DC or AC voltage calibres.

There are specific models in the MN series that have been designed with particular applications in mind such as measurement on current transformer outputs, on oscilloscopes and even of leakage currents.

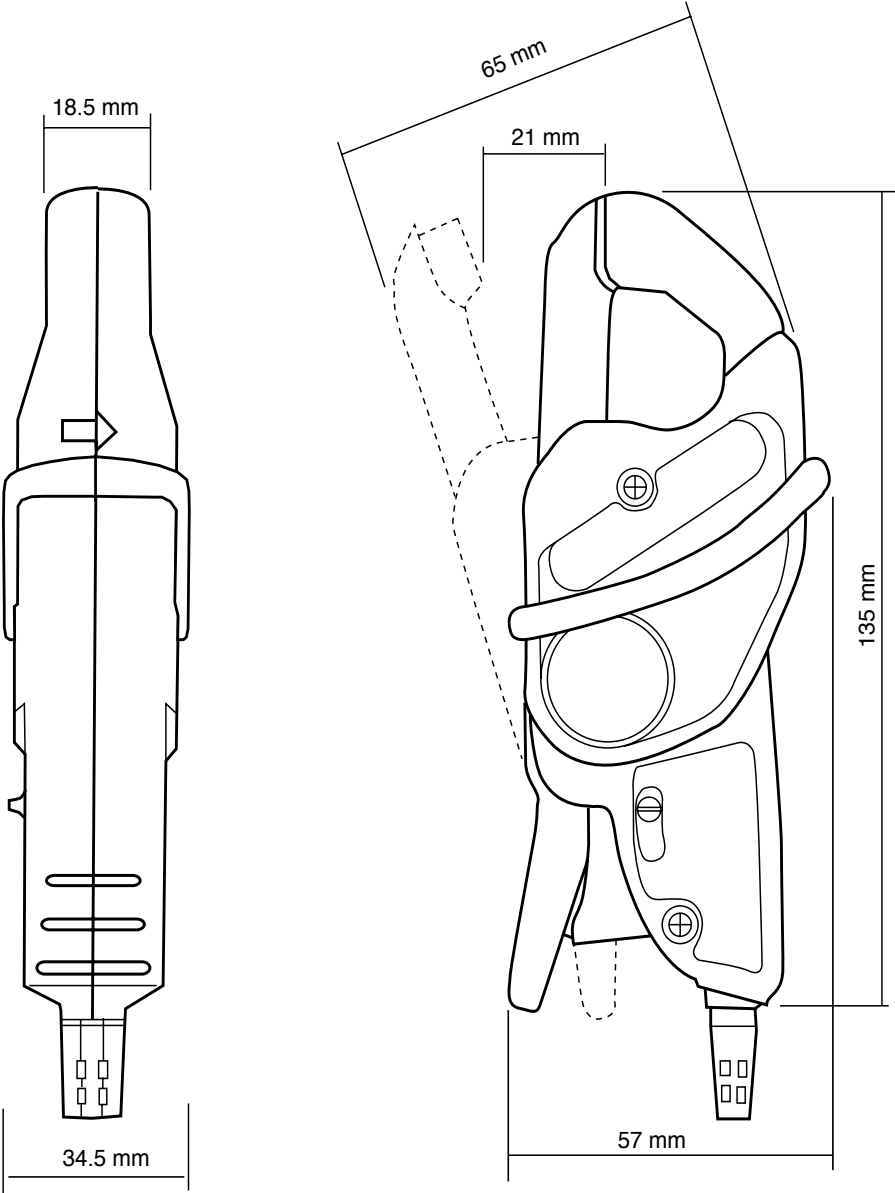

Current clamps for AC current models MN08 and MN09

MN series

Current	200 A AC
Ratio	1000/1
Output	1 mA/A

Electrical specifications

Current calibre:

0.5 A AC ... 240 A AC

Current transformation ratio:

1000/1

Output signal:

1 mA AC/A AC (240 mA for 240 A)

Accuracy and phase shift⁽¹⁾:

Primary current	0.5 A...10 A	10 A...40 A	40 A...100 A	100 A...240 A
% Accuracy of output signal	≤ 3 % + 0.5 mA	≤ 2.5 % + 0.5 mA	≤ 2 % + 0.5 mA	≤ 1 % + 0.5 mA
Phase shift	not specified	≤ 5°	≤ 3°	≤ 2.5°

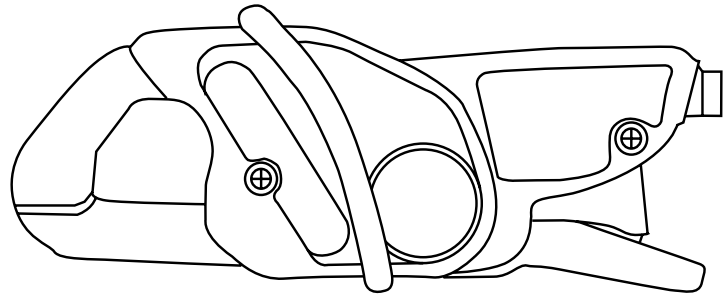

Bandwidth:

40 Hz ... 10 kHz

Crest factor:

3 for a current of 200 A rms

Maximum currents:

200 A continuous for a frequency ≤ 3 kHz (limitation proportional to the inverse of one third of frequency beyond)

Load impedance:

≤ 10 Ω

Operating voltage:

600 V rms

Common mode voltage:

600 V category III and pollution degree 2

Influence of adjacent conductor:

≤ 15 mA/A at 50 Hz

Influence of conductor position in jaws:

≤ 0.5 % of output signal at 50/60 Hz

Load influence: 0.2 ... 10 Ω

< 0.5 % on measurement

< 0.5° on phase

Influence of frequency⁽²⁾:

< 3 % of output signal from 40 Hz ... 1 kHz

< 12 % of output signal from 1 kHz ... 10 kHz

Influence of crest factor:

< 4 % of output signal for a crest factor of 3 and current 200 of A rms

Mechanical specifications

Operating temperature:

-10 °C to +55 °C

Storage temperature:

-40 °C to +70 °C

Influence of temperature:

≤ 0.15 % of output signal per 10 °K

Relative humidity for operation:

0 to 85 % RH decreasing linearly above 35 °C

Influence of relative humidity:

< 0.2 % of output signal from 10 % to 85 % RH

Operating altitude:

0 to 2,000 m

Max. jaw opening: 20 mm

Clamping capacity:

Cable: Ø max 20 mm

Busbar: 1 busbar of 20 x 5 mm

Casing protection rating:

IP40 (IEC 529)

Drop test: 1 m (IEC 68-2-32)

Shock resistance:

100 g (IEC 68-2-27)

Vibration resistance:

10/55/10 Hz, 0.15 mm (IEC 68-2-6)

Self-extinguishing capability:

Casing: UL94 V2

Jaws: UL94 V0

Dimensions:

135 x 51 x 30 mm

Weight:

180 g

Colours:

Dark grey case with red jaws

Output:

MN08:

Safety sockets (4 mm)

MN09:

1.5 m two-wire lead with double or reinforced insulation terminated by 2 elbowed male safety plugs (4 mm)

Safety specifications

Electrical safety:

Instrument with double insulation or reinforced insulation between the primary, the secondary and the grippable part located under the guard as per IEC 1010-1 & IEC 1010-2-032.

- 600 V category III, pollution degree 2

- 300 V category IV, pollution degree 2

Electromagnetic compatibility (EMC):

EN 50081-1: class B

EN 50082-2:

- Electrostatic discharge: IEC 1000-4-2

- Radiated field: IEC 1000-4-3

- Fast transients: IEC 1000-4-4

- Magnetic field at 50/60 Hz: IEC 1000-4-8

(1) Conditions of reference: 23 °C ± 3 °K, 20 to 70 % RH, sinusoidal signal with frequency of 48 Hz to 65 Hz, external magnetic field < 40 A/m, no DC components, no external conductor with circulating current, conductor centred for measurement, 1 Ω load.

(2) Out of reference domain.

To order	Reference
AC current clamp model MN08 with operating manual	P01120401
AC current clamp model MN09 with operating manual	P01120402

Current clamps for AC current models n^o and n^o

MN series

Current	200 A AC
Ratio	1000/1
Output	1 mA/A

Description

An electronic voltage-limiting system protects output of clamp when operating, if the secondary circuit is opened.

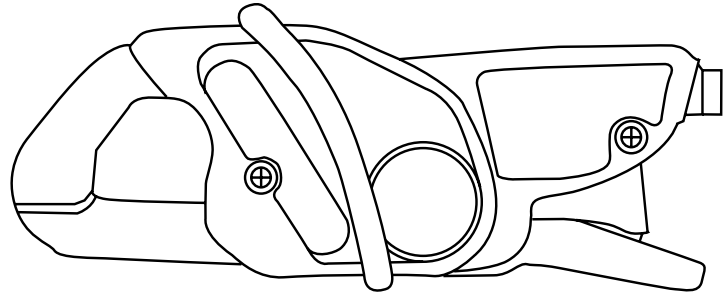

Electrical specifications

Current calibre:

0.5 A AC ... 240 A AC

Current transformation ratio:

1000/1

Output signal:

1 mA AC / A AC (240 mA for 240 A)

Accuracy and phase shift⁽¹⁾:

Primary current	0.5 A...10 A	10 A...40 A	40 A...100 A	100 A...150 A	150 A...200 A	200 A...240 A
Accuracy in % of output signal	≤ 3 % + 0.5 mA	≤ 2.5 % + 0.5 mA	≤ 2 % + 0.5 mA	≤ 1 % + 0.5 mA	≤ 2 % + 0.5 mA	≤ 3 % + 0.5 mA
Phase shift	not specified	≤ 5°	≤ 3°	≤ 2.5°	≤ 2.5°	≤ 2.5°

Bandwidth:

40 Hz ... 10 kHz

Crest factor:

3 for a current of 200 Arms

Maximum currents:

200 A continuous for a frequency ≤ 3 kHz (limitation proportional to the inverse of one third of frequency beyond)

Load impedance:

≤ 10 Ω

Maximum output voltage (secondary open):

Limited to 8 V peak max.

Operating voltage:

600 Vrms

Common mode voltage:

600 V category III and pollution degree 2

Influence of adjacent conductor:

≤ 15 mA/A at 50 Hz

Influence of conductor position in jaws:

≤ 0.5 % of output signal at 50/60 Hz

Load influence: 0.2 ... 10 Ω

< 0.5 % on measurement

< 0.5° on phase

Influence of frequency⁽²⁾:

< 3 % of output signal from 40 Hz ... 1 kHz

< 12 % of output signal from 1 kHz ... 10 kHz

Influence of crest factor:

< 4 % of output signal for a crest factor of 3 and current of 200 A rms

Mechanical specifications

Operating temperature:

-10 °C to +55 °C

Storage temperature:

-40 °C to +70 °C

Influence of temperature:

≤ 0.15 % of output signal per 10 °K

Relative humidity for operation:

0 to 85 % RH decreasing linearly above 35 °C

Influence of relative humidity:

< 0.2 % of output signal from 10 % to 85 % RH

Operating altitude:

0 to 2,000 m

Max. jaw opening:

20 mm

Clamping capacity:

Cable: Ø max 20 mm

Busbar: 1 busbar of 20 x 5 mm

Casing protection rating:

IP40 (IEC 529)

Drop test:

1 m (IEC 68-2-32)

Shock resistance:

100 g (IEC 68-2-27)

Vibration resistance:

10/55/10 Hz, 0.15 mm (IEC 68-2-6)

Self-extinguishing capability:

Casing: UL94 V2

Jaws: UL94 V0

Dimensions:

135 x 51 x 30 mm

Weight:

180 g

Colours:

Dark grey case with red jaws

Output:

MN10:

Safety sockets (4 mm)

MN11:

1.5 m two-wire lead with double or reinforced insulation terminated by 2 elbowed male safety plugs (4 mm)

Safety specifications

Electrical safety:

Instrument with double insulation or reinforced insulation between the primary, the secondary and the grippable part located under the guard as per IEC 1010-1 & IEC 1010-2-032

- 600 V category III, pollution degree 2

- 300 V category IV, pollution degree 2

- 300 V category IV, pollution degree 2

Electromagnetic compatibility (EMC):

EN 50081-1: class B

EN 50082-2:

- Electrostatic discharge: IEC 1000-4-2

- Radiated field: IEC 1000-4-3

- Fast transients: IEC 1000-4-4

- Magnetic field at 50/60 Hz: IEC 1000-4-8

(1) Conditions of reference: 23 °C ± 3 °K, 20 to 70 % RH, sinusoidal signal with frequency of 48 Hz to 65 Hz, external magnetic field < 40 A/m, no DC components, no external conductor with circulating current, conductor centred for measurement, 1 Ω load.

(2) Out of reference domain.

To order	Reference
AC current clamp model MN10 with operating manual	P01120403
AC current clamp model MN11 with operating manual	P01120404

Current clamps for AC current models n[“] and n[“]

MN series

Current	200 A AC
Output	10 mV/A

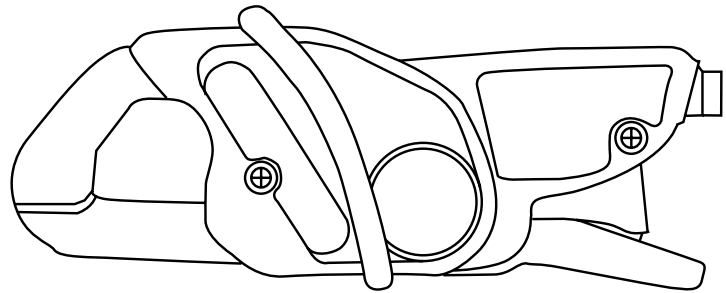

Electrical specifications

Current calibre:

0.5 A AC ... 240 A AC

Output signal:

10 mV/AC/A AC (2.4 V for 240 A)

Accuracy and phase shift ⁽¹⁾:

Primary current	0.5 A...10 A	10 A...40 A	40 A...100 A	100 A...240 A
% Accuracy of output signal	≤ 3.5 % + 5 mV	≤ 2.5 % + 5 mV	≤ 2 % + 5 mV	≤ 1 % + 5 mV
Phase shift	not specified	≤ 5°	≤ 3°	≤ 2.5°

Bandwidth:

40 Hz ... 10 kHz

Crest factor:

3 for a current of 200 Arms

Maximum currents:

200 A continuous for a frequency ≤ 1 kHz (derating proportional to the inverse of frequency beyond)

Load impedance:

> 1 MΩ

Operating voltage:

600 V rms

Common mode voltage:

600 V category III and pollution degree 2

Influence of adjacent conductor:

≤ 15 mA/A at 50 Hz

Influence of conductor position in jaws:

≤ 0.5 % of output signal at 50/60 Hz

Influence of frequency ⁽²⁾:

< 3 % of output signal from 40 Hz ... 1 kHz
< 12 % of output signal from 1 kHz ... 10 kHz

Influence of crest factor:

< 3 % of output signal for a crest factor of 3 and current of 200 A rms

Mechanical specifications

Operating temperature:

-10 °C to +55 °C

Storage temperature:

-40 °C to +70 °C

Influence of temperature:

≤ 0.15 % of output signal per 10 °K

Relative humidity for operation:

0 to 85 % RH decreasing linearly above 35 °C

Influence of relative humidity:

< 0.2 % of output signal from 10 % to 85 % RH

Operating altitude:

0 to 2,000 m

Max. jaw opening:

20 mm

Clamping capacity:

Cable: Ø max 20 mm
Busbar: 1 busbar of 20 x 5 mm

Casing protection rating:

IP40 (IEC 529)

Drop test: 1 m (IEC 68-2-32)

Shock resistance:

100 g (IEC 68-2-27)

Vibration resistance:

10/55/10Hz, 0.15 mm (IEC 68-2-6)

Self-extinguishing capability:

Casing: UL94 V2
Jaws: UL94 V0

Dimensions:

135 x 51 x 30 mm

Weight:

180 g

Colours:

Dark grey case with red jaws

Output:

MN12:

Safety sockets (4 mm)

MN13:

1.5 m two-wire lead with double or reinforced insulation terminated by 2 elbowed male safety plugs (4 mm)

Safety specifications

Electrical safety:

Instrument with double insulation or reinforced insulation between the primary, the secondary and the grippable part located under the guard as per IEC 1010-1 & IEC 1010-2-032

- 600 V category III, pollution degree 2

- 300 V category IV, pollution degree 2

Electromagnetic compatibility (EMC):

EN 50081-1: class B

EN 50082-2:

- Electrostatic discharge: IEC 1000-4-2

- Radiated field: IEC 1000-4-3

- Fast transients: IEC 1000-4-4

- Magnetic field at 50/60 Hz: IEC 1000-4-8

(1) Conditions of reference: 23 °C ± 3 °K, 20 to 70 % RH, sinusoidal signal with frequency of 48 Hz to 65 Hz, external magnetic field < 40 A/m, no DC components, no external conductor with circulating current, conductor centred for measurement, load impedance > 1 MΩ.

(2) Out of reference domain

To order	Reference
AC current clamp model MN12 with operating manual	P01120405
AC current clamp model MN13 with operating manual	P01120406

Current clamps for AC current models n^o and n^o

MN series

Current	200 A AC
Output	1 mV/A

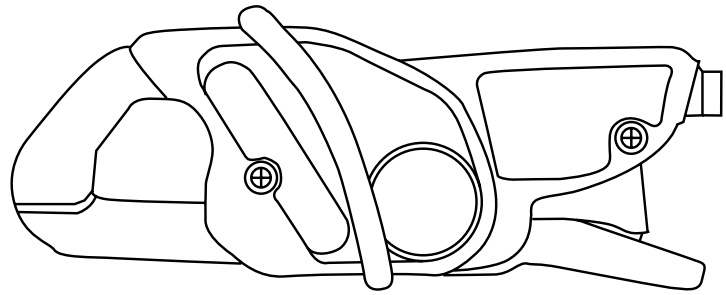

■ Electrical specifications

Current calibre:

0.5 A AC ... 240 A AC

Output signal:

1 mVAC/A AC (240 mV for 240 A)

Accuracy and phase shift ⁽¹⁾:

Primary current	0.5 A...10 A	10 A...40 A	40 A...100 A	100 A...240 A
% Accuracy of output signal	≤ 3 % + 5 mV	≤ 2.5 % + 5 mV	≤ 2 % + 5 mV	≤ 1 % + 5 mV
Phase shift	not specified	≤ 5°	≤ 3°	≤ 2.5°

Bandwidth:

40 Hz ... 10 kHz

Crest factor:

3 for a current of 200 Arms

Maximum currents:

200 A continuous for a frequency ≤ 1 kHz (limitation proportional to the inverse of frequency beyond)

Load impedance:

> 1 MΩ

Operating voltage:

600 V rms

Common mode voltage:

600 V category III and pollution degree 2

Influence of adjacent conductor:

≤ 15 mA/A at 50/60 Hz

Influence of conductor position in jaws:

≤ 0.5 % of output signal at 50/60 Hz

Influence of frequency ⁽²⁾:

< 3 % of output signal from 40 Hz ... 1 kHz

< 12 % of output signal from 1 kHz ... 10 kHz

Influence of crest factor:

< 3 % of output signal for a crest factor of 3 and current of 200 A rms

■ Mechanical specifications

Operating temperature:

-10 °C to +55 °C

Storage temperature:

-40 °C to +70 °C

Influence of temperature:

≤ 0.15 % of output signal per 10 °K

Relative humidity for operation:

0 to 85 % RH decreasing linearly above 35 °C

Influence of relative humidity:

< 0.2 % of output signal of 10 % at 90 % RH

Operating altitude:

0 to 2,000 m

Max. jaw opening:

20 mm

Clamping capacity:

Cable: Ø max 20 mm

Busbar: 1 busbar of 20 x 5 mm

Casing protection rating:

IP40 (IEC 529)

Drop test:

1 m (IEC 68-2-32)

Shock resistance:

100 g (IEC 68-2-27)

Vibration resistance:

10/55/10 Hz, 0.15 mm (IEC 68-2-6)

Self-extinguishing capability:

Casing: UL94 V2

Jaws: UL94 V0

Dimensions:

135 x 51 x 30 mm

Weight:

180 g

Colours:

Dark grey case with red jaws

Output:

MN14:

Safety sockets (4 mm)

MN15:

1.5 m two-wire lead with double or reinforced insulation terminated by 2 elbowed male safety plugs (4 mm)

■ Safety specifications

Electrical safety:

Instrument with double insulation or reinforced insulation between the primary, the secondary and the grippable part located under the guard as per IEC 1010-1 & IEC 1010-2-032

- 600 V category III, pollution degree 2

- 300 V category IV, pollution degree 2

Electromagnetic compatibility (EMC):

EN 50081-1: class B

EN 50082-2:

- Electrostatic discharge: IEC 1000-4-2

- Radiated field: IEC 1000-4-3

- Fast transients: IEC 1000-4-4

- Magnetic field at 50 Hz: IEC 1000-4-8

(1) Conditions of reference: 23 °C ± 3 °K, 20 to 70 % RH, sinusoidal signal with frequency of 48 Hz to 65 Hz, external magnetic field < 40 A/m, no DC components, no external conductor with circulating current, conductor centred for measurement, load impedance > 1 MΩ.

(2) Out of reference domain

To order	Reference
AC current clamp model MN14 with operating manual	P01120416
AC current clamp model MN15 with operating manual	P01120417

odel n”“

Current	200 A AC
Ratio	1000/1
Output	1 mA/A

Description

An electronic voltage-limiting system protects output of clamp when operating, if the secondary circuit is opened.

Electrical specifications

Current calibre:

0.1 A AC ... 240 A AC

Current transformation ratio: 1000/1

Output signal:

1 mA AC/A AC (240 mA for 240 A)

Accuracy and phase shift ⁽¹⁾:

Primary current	0.1 A...10 A	1 A...20 A	20 A...80 A	80 A...150 A	150 A...200 A
% Accuracy of output signal	≤ 2 % + 20 μA	≤ 1 % + 20 μA	≤ 1 %	≤ 2 %	≤ 4 %
Phase shift	not specified	≤ 2°	≤ 1.5°	≤ 1.5°	≤ 2°

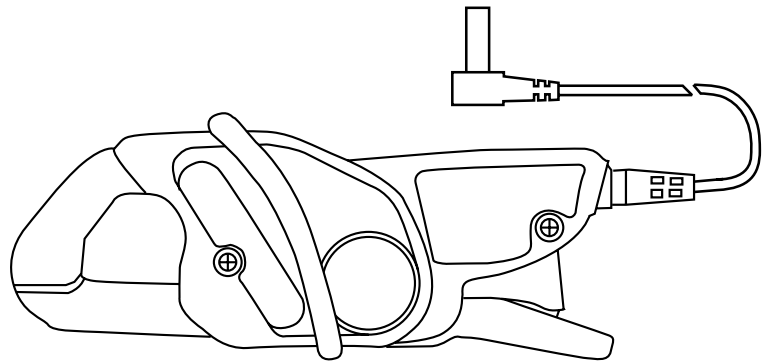

Bandwidth:

40Hz ... 10kHz

Crest factor:

5 for a current of 280 A peak

Maximum currents:

200 A continuous for a frequency ≤ 3 kHz (limitation proportional to the inverse of one third of frequency beyond)

Load impedance:

≤ 10 Ω

Maximum output voltage

(secondary open):

Limited to 8 V peak max.

Operating voltage:

600 Vrms

Common mode voltage:

600 V category III and pollution degree 2

Influence of adjacent conductor:

≤ 15 mA/A at 50 Hz

Influence of conductor position in jaws:

≤ 0.5 % of output signal at 50/60 Hz

Load influence:

0.1 ... 5 Ω

< 0.5 % on measurement

< 0.5° on phase

Influence of frequency I_p < 150 A ⁽²⁾:

< 5 % of output signal from 40 Hz ... 1 kHz

< 15 % of output signal from 1 kHz ... 10 kHz

add 5 % error if 150 A < I_p < 200 A

Influence of crest factor:

< 3 % of output signal for crest factor < 5 with current < 280 A peak (50 Arms)

Mechanical specifications

Operating temperature:

-10 °C to +55 °C

Storage temperature:

-40 °C to +70 °C

Influence of temperature:

≤ 0.20 % of output signal per 10 °K

Relative humidity for operation:

0 to 85 % RH decreasing linearly above 35 °C

Influence of relative humidity:

< 0.2 % of output signal from 10 % to 85 % RH

Operating altitude:

0 to 2,000 m

Max. jaw opening:

20 mm

Clamping capacity:

Cable: Ø max 20 mm

Busbar: 1 busbar of 20 x 5 mm

Casing protection rating:

IP40 (IEC 529)

Drop test: 1 m (IEC 68-2-32)

Shock resistance:

100 g (IEC 68-2-27)

Vibration resistance:

10/55/10 Hz, 0.15 mm (IEC 68-2-6)

Self-extinguishing capability:

Casing: UL94 V2

Jaws: UL94 V0

Dimensions:

135 x 51 x 30 mm

Weight:

180 g

Colours:

Dark grey case with red jaws

Output:

1.5 m two-wire lead with double or reinforced insulation terminated by 2 elbowed male safety plugs (4 mm)

Safety specifications

Electrical safety:

Instrument with double insulation or reinforced insulation between the primary, the secondary and the grippable part located under the guard as per IEC 1010-1 & IEC 1010-2-032

- 600 V category III, pollution degree 2

- 300 V category IV, pollution degree 2

Electromagnetic compatibility (EMC):

EN 50081-1: class B

EN 50082-2:

- Electrostatic discharge: IEC 1000-4-2

- Radiated field: IEC 1000-4-3

- Fast transients: IEC 1000-4-4

- Magnetic field at 50 Hz: IEC 1000-4-8

(1) Conditions of reference: 23 °C ± 3 °K, 20 to 70 % RH, sinusoidal signal with frequency of 48 Hz to 65 Hz, external magnetic field < 40 A/m, no DC components, no external conductor with circulating current, conductor centred for measurement, 1 Ω load.

(2) Out of reference domain

To order	Reference
AC current clamp model MN21 with operating manual	P01120418

odel n”

Current	200 A AC
Output	10 mV/A

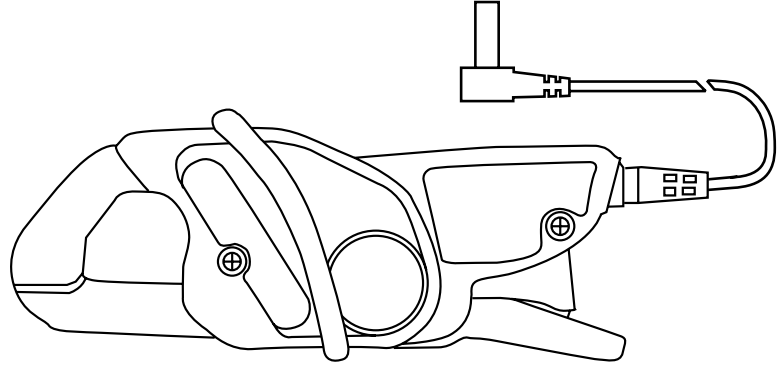

Electrical specifications

Current calibre:

0.1 A AC ... 240 A AC

Output signal:

10 mVAC/A AC (2.4 V for 240 A)

Accuracy and phase shift⁽¹⁾:

Primary current	0.1 A...1 A	1 A...20 A	20 A...80 A	80 A...150 A	150 A...200 A
% Accuracy of output signal	≤ 3 % + 200 μA	≤ 2 % + 200 μA	≤ 1 %	≤ 4 %	≤ 10 %
Phase shift	not specified	≤ 3°	≤ 2°	≤ 2.5°	≤ 3.5°

Bandwidth:

40 Hz ... 10 kHz

Crest factor:

5 for a current of 280 A peak

Maximum currents:

200 A continuous for a frequency ≤ 1 kHz (limitation proportional to the inverse of frequency beyond)

Load impedance:

> 1 MΩ

Operating voltage:

600 Vrms

Common mode voltage:

600 V category III and pollution degree 2

Influence of adjacent conductor:

≤ 15 mA/A at 50 Hz

Influence of conductor position in jaws:

≤ 0.5 % of output signal at 50/60 Hz

Influence of frequency at IP < 100 A⁽²⁾:

< 5 % of output signal from 40 Hz ... 1 kHz**

< 15 % of output signal from 1 kHz ... 10 kHz

**Add 10 % error if 100 < IP < 200 A

Influence of crest factor:

< 3 % of output signal for a crest factor < 5 to a current < 280 A peak (50 A rms)

Mechanical specifications

Operating temperature:

-10 °C to +55 °C

Storage temperature:

-40 °C to +70 °C

Influence of temperature:

≤ 0.20 % of output signal per 10 °K

Relative humidity for operation:

0 to 85 % RH decreasing linearly above 35 °C

Influence of relative humidity:

< 0.2 % of output signal from 10 % to 85 % RH

Operating altitude:

0 to 2,000 m

Max. jaw opening:

20 mm

Clamping capacity:

Cable: Ø max 20 mm

Busbar: 1 busbar of 20 x 5 mm

Casing protection rating:

IP40 (IEC 529)

Drop test: 1 m (IEC 68-2-32)

Shock resistance:

100 g (IEC 68-2-27)

Vibration resistance:

10/55/10 Hz, 0.15 mm (IEC 68-2-6)

Self-extinguishing capability:

Casing: UL94 V2

Jaws: UL94 V0

Dimensions:

135 x 51 x 30 mm

Weight:

180 g

Colours:

Dark grey case with red jaws

Output:

1.5 m two-wire lead with double or reinforced insulation terminated by 2 elbowed male safety plugs (4 mm)

Safety specifications

Electrical safety:

Instrument with double insulation or reinforced insulation between the primary, the secondary and the grippable part located under the guard as per IEC 1010-1 & IEC 1010-2-032

- 606,5 V category III, pollution degree 2

- 306,5 V category IV, pollution degree 2

Electromagnetic compatibility (EMC):

EN 50081-1: class B

EN 50082-2:

- Electrostatic discharge: IEC 1000-4-2

- Radiated field: IEC 1000-4-3

- Fast transients: IEC 1000-4-4

- Magnetic field at 50 Hz:

IEC 1000-4-8

(1) Conditions of reference: 23 °C ± 3 °K, 20 to 70 % RH, sinusoidal signal with frequency of 48 Hz to 65 Hz, external magnetic field < 40 A/m, no DC components, no external conductor with circulating current, conductor centred for measurement, load impedance > 1 MΩ.

(2) Out of reference domain

To order	Reference
AC current clamp model MN23 with operating manual	P01120419

Current clamps for AC current models MN38 and MN39

MN series

Current	20 A AC	200 A AC
Output	100 mV/A	10 mV/A

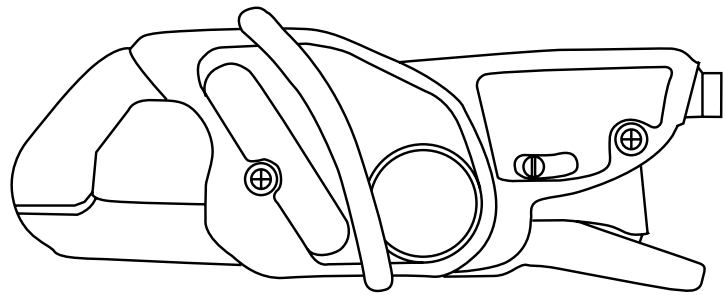

Electrical specifications

Current calibres:
0.1 A AC...24 A AC
0.5 A AC...240 A AC

Output signal:
100 mVAC/A AC (2.4 V for 24 A)
10 mVAC/A AC (2.4 V for 240 A)

Accuracy and phase shift⁽¹⁾:

Calibre	200 A				
	20 A	0.5 A...10 A	10 A...40 A	40 A...100 A	100 A...240 A
Primary current	0.1 A...20 A	0.5 A...10 A	10 A...40 A	40 A...100 A	100 A...240 A
% Accuracy of output signal	≤ 1 % + 50 mV	≤ 3 % + 5 mV	≤ 2.5 % + 5 mV	≤ 2 % + 5 mV	≤ 1 % + 5 mV
Phase shift	not specified	not specified	≤ 5°	≤ 3°	≤ 2.5°

Bandwidth:
40 Hz...10 kHz

Crest factor:
3 for a current of 200 Arms

Maximum currents:
200 A continuous for a frequency ≤ 1 kHz (limitation proportional to the inverse of frequency beyond)

Load impedance:
> 1 MΩ

Operating voltage:
600 V rms

Common mode voltage:
600 V category III and pollution degree 2

Influence of adjacent conductor:
≤ 15 mA/A at 50 Hz

Influence of conductor position in jaws:
≤ 0.5 % of output signal at 50/60 Hz

Influence of frequency⁽²⁾:
20 A calibre:

< 5 % of output signal from 40 Hz...1 kHz
< 15 % of output signal from 1 kHz...10 kHz

200 A calibre:
< 3 % of output signal from 40 Hz...1 kHz
< 12 % of output signal from 1 kHz...10 kHz

Influence of crest factor:
< 3 % of output signal for a crest factor of 3 and current of 200 A rms

Mechanical specifications

Operating temperature:
-10 °C to +55 °C

Storage temperature:
-40 °C to +70 °C

Influence of temperature:
≤ 0.15 % of output signal per 10 °K

Relative humidity for operation:
0 to 85 % RH decreasing linearly above 35 °C

Influence of relative humidity:
< 0.2 % of output signal from 10 % to 85 % RH

Operating altitude:
0 to 2,000 m

Max. jaw opening:
20 mm

Clamping capacity:
Cable: Ø max 20 mm
Busbar: 1 busbar of 20 mm x 5 mm

Casing protection rating:
IP40 (IEC 529)

Drop test:
1 m (IEC 68-2-32)

Shock resistance:
100 g (IEC 68-2-27)

Vibration resistance:
10/55/10 Hz, 0.15 mm (IEC 68-2-6)

Self-extinguishing capability:
Casing: UL94 V2
Jaws: UL94 V0

Dimensions:
135 x 51 x 30 mm

Weight:
180 g

Colours:
Dark grey case with red jaws

Output:
MN38:
Safety jacks (4 mm)

MN39:
1.5 m two-wire lead with double or reinforced insulation terminated by 2 elbowed male safety plugs (4 mm)

Safety specifications

Electrical safety:
Instrument with double insulation or reinforced insulation between the primary, the secondary and the grippable part located under the guard as per IEC 1010-1 & IEC 1010-2-032

- 600 V category III, pollution degree 2
- 300 V category IV, pollution degree 2

Electromagnetic compatibility (EMC):
EN 50081-1: class B

EN 50082-2:

- Electrostatic discharge: IEC 1000-4-2
- Radiated field: IEC 1000-4-3
- Fast transients: IEC 1000-4-4
- Magnetic field at 50/60 Hz: IEC 1000-4-8

(1) Conditions of reference: 23 °C ± 3 °K, 20 to 70 % RH, sinusoidal signal with frequency of 48 Hz to 65 Hz, external magnetic field < 40 A/m, no DC components, no external conductor with circulating current, conductor centred for measurement, load impedance > 1 MΩ.

(2) Out of reference domain

To order	Reference
AC current clamp model MN38 with operating manual	P01120407
AC current clamp model MN39 with operating manual	P01120408

odel n insulated AC current probe

Current	60 A peak	600 A peak
Output	100 mV/A	10 mV/A

Description

This 200 A AC clamp enables easy display and measurement of "current" curves. It fits any oscilloscope since it has a coaxial lead with BNC plug. It produces a mV signal directly proportional to current. It offers 2 different sensitivities.

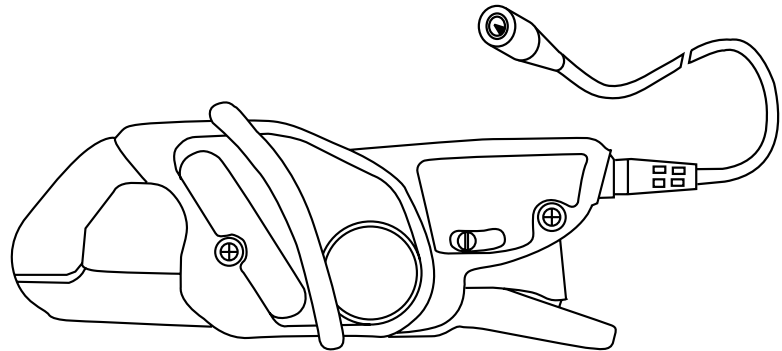

Electrical specifications

Current calibres:

0.1 A AC ... 20 A AC (60 A peak)
0.5 A AC ... 200 A AC (600 A peak)

Output signal:

100 mVAC/A AC (2 V for 20 A)
10 mVAC/A AC (2 V for 200 A)

Accuracy and phase shift ⁽¹⁾:

Calibre	200 A				
	20 A	0.5 A...10 A	10 A...40 A	40 A...100 A	100 A...240 A
Primary current	0.1 A...20 A	0.5 A...10 A	10 A...40 A	40 A...100 A	100 A...240 A
Accuracy in % of output signal	≤ 2 % + 50 mV	≤ 3.5 % + 5 mV	≤ 3 % + 5 mV	≤ 2.5 % + 5 mV	≤ 1.5 % + 5 mV
Phase shift	not specified	not specified	≤ 6°	≤ 4°	≤ 3°

Bandwidth:

40 Hz ... 40 kHz (-3 dB) (depending on current value)

Rise/fall time from 10 % to 90 %:

20 A calibre: 7.4 μs
200 A calibre: 8.7 μs

10 % delay time: 0.1 μs

Ampere second product:

20 A calibre: 25 A.s
200 A calibre: 2 A.s

Insertion impedance (at 400 Hz / 10 kHz)

20 A calibre: < 0.3 mΩ / < 7.2 mΩ
200 A calibre: < 1 mΩ / < 26 mΩ

Maximum currents:

200 A continuous for a frequency ≤ 3 kHz (limitation proportional to inverse of one third of frequency beyond)

Influence of temperature:

≤ 150 ppm / K or 0.15 % of output signal per 10 °K

Influence of relative humidity:

< 0.2 % of output signal

Influence of adjacent conductor:

≤ 15 mA/A at 50 Hz

Influence of DC current < 10 % of rated calibre superimposed on the rated current:

20 A calibre:
For I DC < 2 A: influence < 0.5 %
200 A calibre:
For I DC < 20 A: influence < 5 %

Influence of conductor position in jaws:

≤ 0.5 % of output signal at 50/60 Hz

Influence of frequency ⁽²⁾:

20 A calibre:
< 10 % of output signal from 40 Hz ... 1 kHz
< 15 % of output signal from 1 kHz ... 10 kHz
200 A calibre:
< 3 % of output signal from 40 Hz ... 1 kHz
< 12 % of output signal from 1 kHz ... 10 kHz

Influence of crest factor:

< 3 % of output signal for a crest factor of 3 and current of 200 A rms

Mechanical specifications

Operating temperature:

-10 °C to +55 °C

Storage temperature:

-40 °C to +70 °C

Relative humidity for operation:

0 to 85 % RH decreasing linearly above 35 °C

Operating altitude:

0 to 2,000 m

Max. jaw opening:

20 mm

Clamping capacity:

Cable: Ø max 20 mm
Busbar: 1 busbar of 20 x 5 mm

Casing protection rating:

IP40 (IEC 529)

Drop test:

1 m (IEC 68-2-32)

Shock resistance:

100 g / 6 ms / half-period (IEC 68-2-27)

Protection against impacts:

IK04 0.5 J (EN 50102)

Vibration resistance:

10/55/10 Hz, 0.15 mm (IEC 68-2-6)

Self-extinguishing capability:

Casing: UL94 V2
Jaws: UL94 V0

Dimensions:

128 x 49 x 28 mm

Weight:

180 g

Colours:

Dark grey case with red jaws

Output:

Coaxial cable 2 m long, terminated by an insulated BNC connector

Safety specifications

Electrical safety:

Instrument with double insulation or reinforced insulation between the primary, the secondary and the grippable part located under the guard as per IEC 1010-1 & IEC 1010-2-032
- 600 V category III, pollution degree 2
- 300 V category IV, pollution degree 2

Electromagnetic compatibility (EMC):

EN 50081-1: class B
EN 50082-2:
- Electrostatic discharge: IEC 1000-4-2
4 kV level 2 performance criterion B
8 kV in the air level 3 performance criterion B
- Radiated field: IEC 1000-4-3
10 V/m performance criterion A
- Fast transients: IEC 1000-4-4
1 kV level 2 performance criterion B
2 kV level 3 performance criterion B
- Magnetic field at 50/60 Hz: IEC 1000-4-8
field of 400 A/m at 50 Hz: < 1 A

oscilloscope clamp for AC current

MN series

odel n insulated AC current probe

Curves at 50 Hz

200 A calibre

20 A calibre

Error on measurement

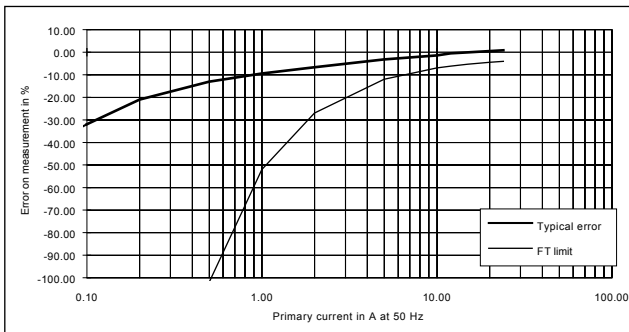
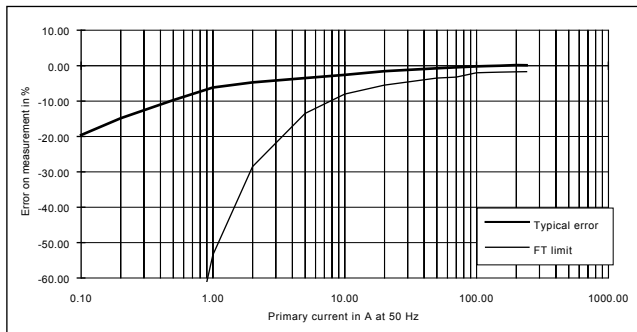

Phase shift

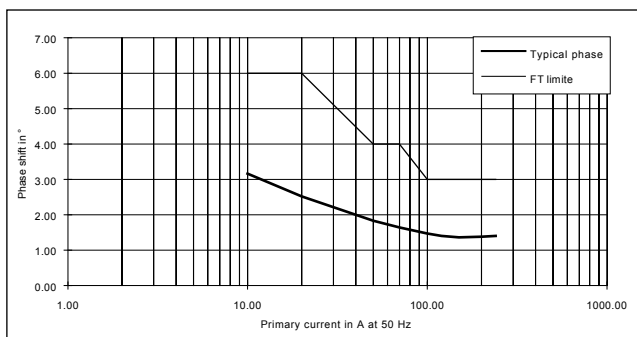

Frequency response

200 A calibre

20 A calibre

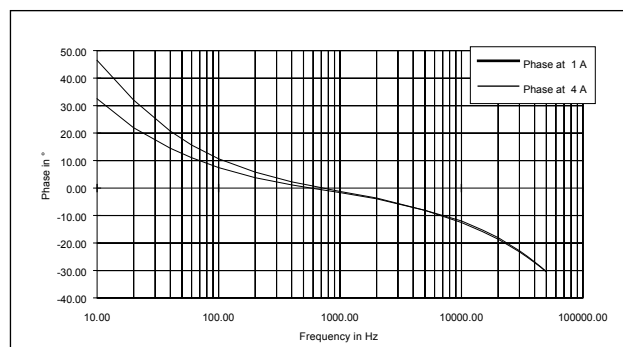
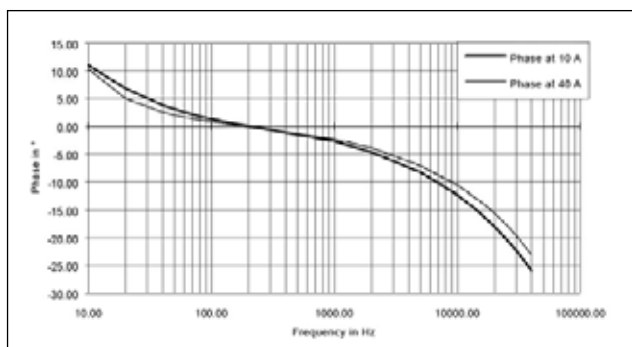
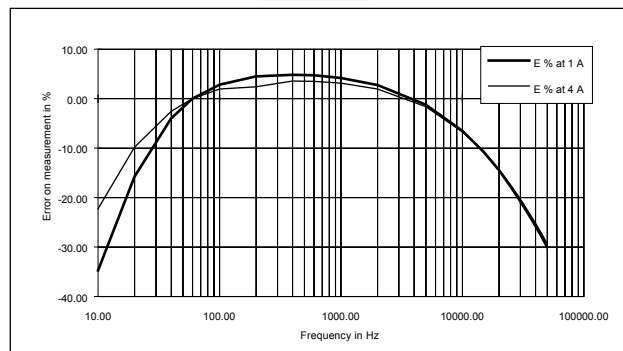
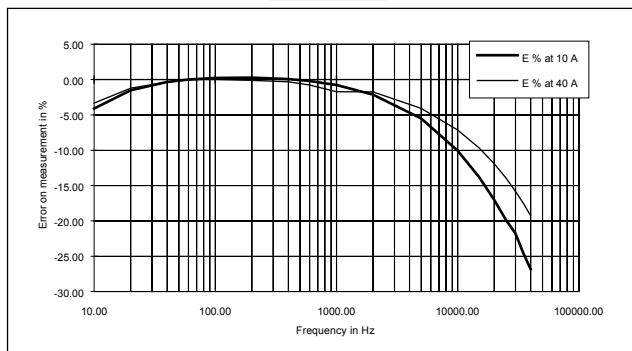

oscilloscope clamp for AC current

odel n insulated AC current probe

MN series

Frequency response (cont.)

200 A calibre

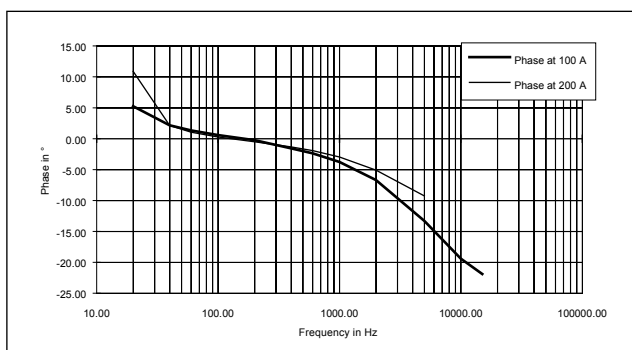
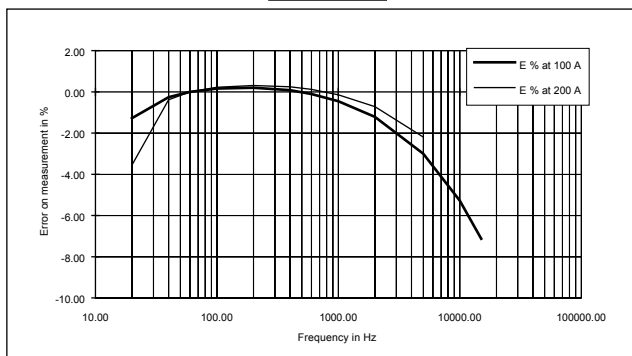

20 A calibre

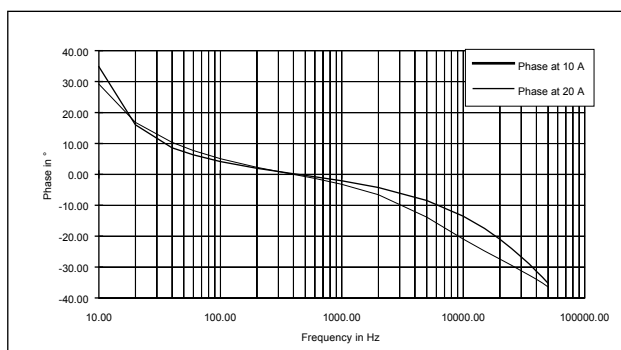
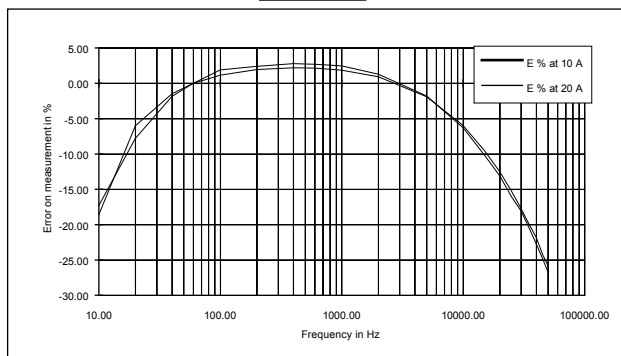

Response to a square signal

200 A calibre

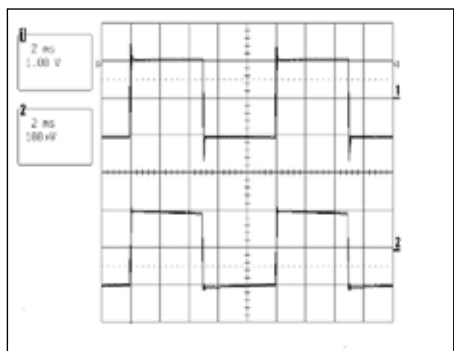
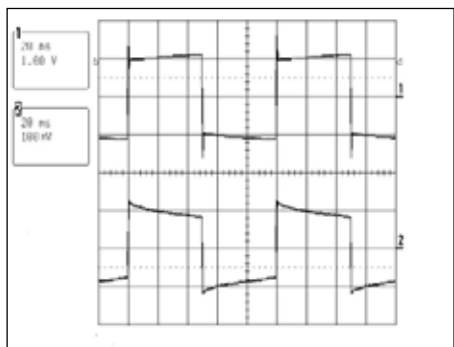

20 A calibre

10 A at 10 Hz

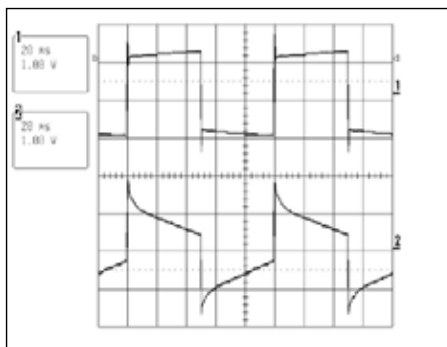

10 A at 100 Hz

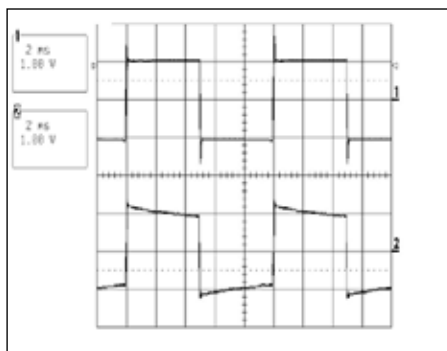

Model n insulated AC current probe

Response to a square signal (cont.)

200 A calibre

20 A calibre

10 A at 1 kHz

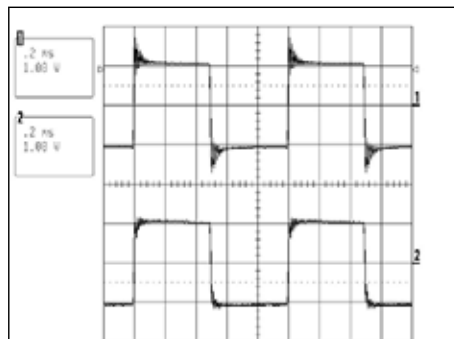
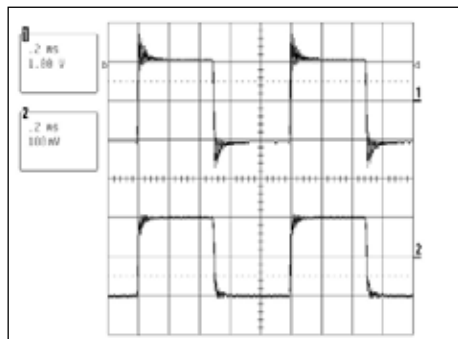

10 A at 10 kHz

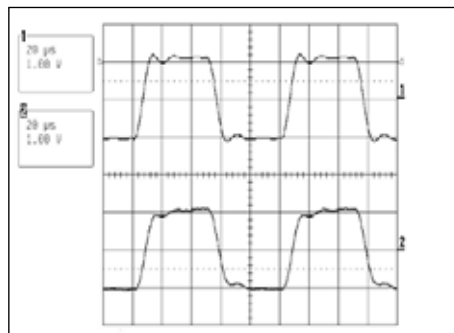
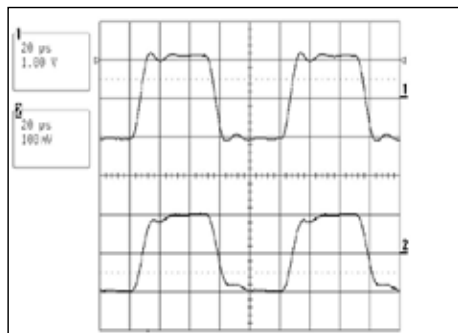

(1) Conditions of reference: 23 °C ± 3 °K, 20 % to 75 % RH, sinusoidal signal with frequency of 48 Hz at 1 kHz, external magnetic field < 40 A/m, no DC components, no external conductor with circulating current, conductor centred for measurement, load impedance > 1 MΩ and < 100 pF.

(2) Out of reference domain

To order	Reference
AC current clamp model MN60 for oscilloscope with operating manual	P01120409

odel n “

Current	10 AAC
Output	100 mV/A

■ Description

This clamp was specially designed to measure current on current transformer secondary circuits.

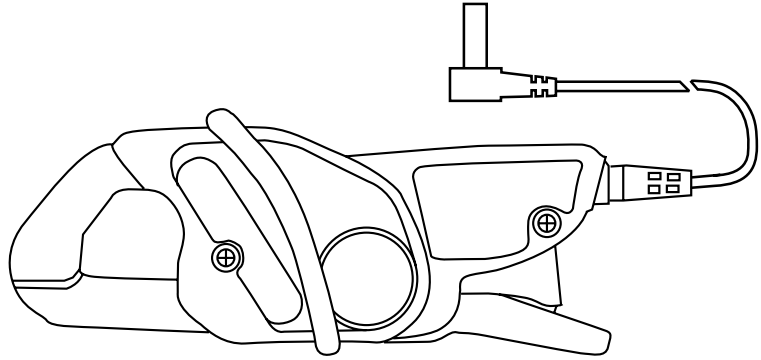

■ Electrical specifications

Current calibre:

0.01 AAC ... 12 AAC

Output signal:

100 mVAC/AAC (1.2 V for 12 A)

Accuracy and phase shift ⁽¹⁾:

Primary current	0.01 A...0.1 A	0.1 A...1 A	1 A...5 A	5 A...12 A
Accuracy in % of output signal	≤ 3 % + 0.1 mV	≤ 2.5 %	≤ 1 %	
Phase shift	not specified	≤ 5°	≤ 3°	≤ 3°

Bandwidth:

40 Hz ... 10 kHz

Crest factor:

5 for a current of 40 A peak (8 Arms)

Maximum currents:

20 A continuous for a frequency ≤ 10 kHz (limitation proportional to the inverse of one tenth of frequency beyond)

Load impedance:

> 1 MΩ

Operating voltage:

600 V rms

Common mode voltage:

600 V category III and pollution degree 2

Influence of adjacent conductor:

< 15 mA/A at 50 Hz

Influence of conductor position in jaws:

< 0.5 % of output signal at 50/60 Hz

Influence of frequency ⁽²⁾:

< 5 % of output signal from 20 Hz ... 1 kHz
< 10 % of output signal from 1 kHz ... 10 kHz

Influence of crest factor:

< 3 % of output signal for crest factor < 5 with current < 40 Arms

■ Mechanical specifications

Operating temperature:

-10 °C to +55 °C

Storage temperature:

-40 °C to +70 °C

Influence of temperature:

≤ 0.2 % of output signal per 10 °K

Relative humidity for operation:

0 to 85 % RH decreasing linearly above 35 °C

Influence of relative humidity:

< 0.2 % of output signal from 10 % to 85 % RH

Operating altitude:

0 to 2,000 m

Max. jaw opening:

20 mm

Clamping capacity:

Cable: Ø max 20 mm
Busbar: 1 busbar of 20 x 5 mm

Casing protection rating:

IP40 (IEC 529)

Drop test:

1 m (IEC 68-2-32)

Shock resistance:

100 g (IEC 68-2-27)

Vibration resistance:

10/55/10 Hz, 0.15 mm (IEC 68-2-6)

Self-extinguishing capability:

Casing: UL94 V2
Jaws: UL94 V0

Dimensions:

135 x 51 x 30 mm

Weight:

180 g

Colours:

Dark grey case with red jaws

Output:

1.5 m two-wire lead with double or reinforced insulation terminated by 2 elbowed male safety plugs (4 mm)

■ Safety specifications:

Electrical safety:

Instrument with double insulation or reinforced insulation between the primary, the secondary and the grippable part located under the guard as per IEC 1010-1 & IEC 1010-2-032

- 600 V category III, pollution degree 2
- 300 V category IV, pollution degree 2

Electromagnetic compatibility (EMC):

- EN 50081-1: class B
- EN 50082-2:
 - Electrostatic discharge: IEC 1000-4-2
 - Radiated field: IEC 1000-4-3
 - Fast transients: IEC 1000-4-4
 - Magnetic field at 50 Hz: IEC 1000-4-8

(1) Conditions of reference: 23 °C ± 3 °K, 20 % to 75 % RH, sinusoidal signal with frequency of 48 Hz to 65 Hz, external magnetic field < 40 A/m, no DC components, no external conductor with circulating current, conductor centred for measurement, load impedance > 1 MΩ.

(2) Out of reference domain

To order	Reference
AC current clamp model MN71 with operating manual	P01120420

odel n

Current	2 AAC	200 AAC
Output	1000 mV/A	10 mV/A

Description

This clamp has a wide measurement range (up to 200 A), and it can also measure very low currents. We call it the "universal" probe.

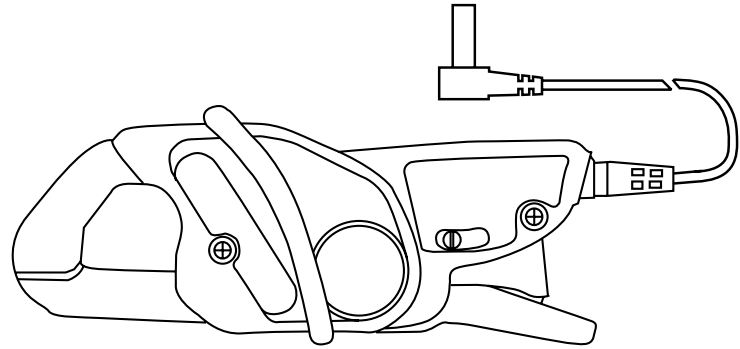

Electrical specifications

Current calibres:

0.01 A AC...2.4 A AC
0.1 A AC...240 A AC

Output signal:

1000 mVAC/A AC (2 V for 2 A)
10 mVAC/A AC (2.4 V for 240 A)

Accuracy and phase shift⁽¹⁾:

Calibre	2 A				200 A				
	0.01 A...0.1 A	0.1 A...1 A	1 A...2 A	2 A...2.4 A	0.1 A...1 A	1 A...20 A	20 A...80 A	80 A...150 A	150 A...200 A
Primary current									
% Accuracy of output signal	≤ 5 % + 2 mV	≤ 3 % + 1 mV	≤ 1 %	≤ 1 %	≤ 3 % + 200 μV	≤ 2 % + 200 μV	≤ 1 %	≤ 4 %	≤ 10 %
Phase shift	not specified				not specified	≤ 3°	≤ 2°	≤ 3°	≤ 4°

Bandwidth:

40 Hz...10 kHz

Crest factor:

5 for a current of 280 A peak (200 A rms)

Maximum currents:

200 A continuous for a frequency ≤ 1 kHz (limitation proportional to the inverse frequency beyond)

Load impedance:

> 1 MΩ

Operating voltage:

600 Vrms

Common mode voltage:

600 V category III and pollution degree 2

Influence of adjacent conductor:

≤ 15 mA/A at 50 Hz

Influence of conductor position in jaws:

≤ 0.5 % of output signal at 50/60 Hz

Influence of frequency⁽²⁾:

2 A calibre:
< 10 % of output signal from 40 Hz...10 kHz

200 A calibre:
< 5 % of output signal from 40 Hz...1 kHz**

< 15 % of output signal from 1 kHz...10 kHz

** add 10 % error if 100 A < I_p < 200 A

Influence of crest factor:

< 5 % of output signal for crest factor < 5 with current < 280 A rms

Mechanical specifications

Operating temperature:

-10 °C to +55 °C

Storage temperature:

-40 °C to +70 °C

Influence of temperature:

≤ 0.20 % of output signal per 10 °K

Relative humidity for operation:

0 to 85 % RH decreasing linearly above 35 °C

Influence of relative humidity:

< 0.2 % of output signal from 10 % to 85 % RH

Operating altitude:

0 to 2,000 m

Max. jaw opening:

20 mm

Clamping capacity:

Cable: Ø max 20 mm
Busbar: 1 busbar of 20 x 5 mm

Casing protection rating:

IP40 (IEC 529)

Drop test:

1 m (IEC 68-2-32)

Shock resistance:

100 g (IEC 68-2-27)

Vibration resistance:

10/55/10 Hz, 0.15 mm (IEC 68-2-6)

Self-extinguishing capability:

Casing: UL94 V2

Jaws: UL94 V0

Dimensions:

135 x 51 x 30 mm

Weight:

180 g

Colours:

Dark grey case with red jaws

Output:

1.5 m two-wire lead with double or reinforced insulation terminated by 2 elbowed male safety plugs (4 mm)

Safety specifications

Electrical safety:

Instrument with double insulation or reinforced insulation between the primary, the secondary and the grippable part located under the guard as per IEC 1010-1 & IEC 1010-2-032

- 600 V category III, pollution degree 2

- 300 V category IV, pollution degree 2

Electromagnetic compatibility (EMC):

EN 50081-1: class B

EN 50082-2:

- Electrostatic discharge: IEC 1000-4-2

- Radiated field: IEC 1000-4-3

- Fast transients: IEC 1000-4-4

- Magnetic field at 50 Hz: IEC 1000-4-8

(1) Conditions of reference: 23 °C ± 3 °K, 20 % to 75 % RH, sinusoidal signal with frequency of 48 Hz to 65 Hz, external magnetic field < 40 A/m, no DC components, no external conductor with circulating current, conductor centred for measurement, load impedance > 1 MΩ.

(2) Out of reference domain

To order	Reference
AC current clamp model MN73 with operating manual	P01120421
Accessory: AN1 artificial neutral box (see chapter 12)	P01197201

Current clamps for AC current models MN88 and MN89

MN series

Current	200 A AC
Output	100 mV DC/A

Description

These clamps produce a DC voltage output which is very useful for multimeters whose sensitivity in V or A is too weak.

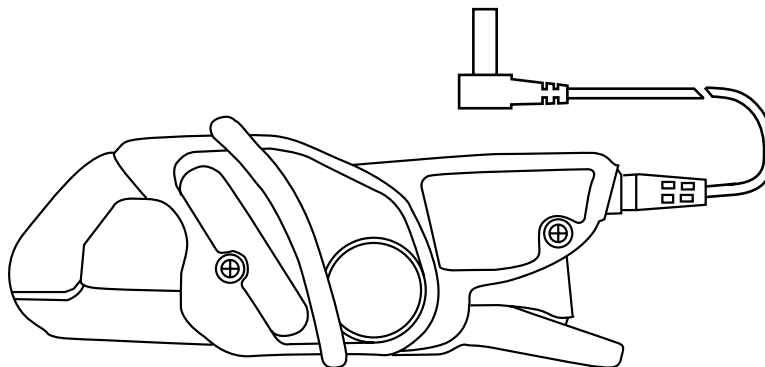

Electrical specifications

Current calibre:

0.5 A AC ... 240 A AC

Output signal:

100 mV DC/A (24 V for 240 A AC)

Accuracy ⁽¹⁾:

Primary current	0.5 A...10 A	10 A...40 A	40 A...100 A	100 A...240 A
Accuracy in % of output signal	≤ 5 % + 50 mV	≤ 3 % + 50 mV	≤ 2 % + 50 mV	≤ 2 %

Bandwidth:

40 Hz ... 10 kHz

Crest factor:

3 for a current of 200 Arms

Maximum currents:

200 A continuous for a frequency ≤ 1 Hz (derating proportional to the inverse of frequency beyond)

Load impedance:

> (1 MΩ + filter RC 2 s)

Operating voltage:

600 V rms

Common mode voltage:

600 V category III and pollution degree 2

Influence of adjacent conductor:

≤ 15 mA / A at 50 Hz

Influence of conductor position in jaws:

≤ 0.5 % of output signal at 50 Hz

Influence of frequency ⁽²⁾:

< 5 % of output signal from 40 Hz ... 1 kHz
< 12 % of output signal from 1 kHz ... 10 kHz

Influence of crest factor

< 3 % of output signal for a crest factor of 3 and current of 200 A rms

Mechanical specifications

Operating temperature:

-10 °C to +55 °C

Storage temperature:

-40 °C to +70 °C

Influence of temperature:

≤ 0.15 % of output signal per 10 °K

Relative humidity for operation:

0 to 85 % RH decreasing linearly above 35 °C

Influence of relative humidity:

< 0.2 % of output signal from 10 % to 85 % RH

Operating altitude:

0 to 2,000 m

Max. jaw opening:

20 mm

Clamping capacity:

Cable: Ø max 20 mm
Busbar: 1 busbar of 20 x 5 mm

Casing protection rating:

IP40 (IEC 529)

Drop test: 1 m (IEC 68-2-32)

Shock resistance:

100 g (IEC 68-2-27)

Vibration resistance:

10/55/10 Hz, 0.15 mm (IEC 68-2-6)

Self-extinguishing capability:

Casing: UL94 V2
Jaws: UL94 V0

Dimensions:

135 x 51 x 30 mm

Weight:

180 g

Colours:

Dark grey case with red jaws

Output:

MN88:

Safety sockets (4 mm)

MN89:

1.5 m two-wire lead with double or reinforced insulation terminated by 2 elbowed male safety plugs (4 mm)

Safety specifications

Electrical safety:

Instrument with double insulation or reinforced insulation between the primary, the secondary and the grippable part located under the guard as per IEC 1010-1 & IEC 1010-2-032

- 600 V category III, pollution degree 2

- 300 V category IV, pollution degree 2

Electromagnetic compatibility (EMC):

EN 50081-1: class B

EN 50082-2:

- Electrostatic discharge: IEC 1000-4-2

- Radiated field: IEC 1000-4-3

- Fast transients: IEC 1000-4-4

- Magnetic field at 50/60 Hz: IEC 1000-4-8

(1) Conditions of reference: 23 °C ± 3 °K, 20 to 70 % RH, sinusoidal signal with frequency of 48 Hz to 65 Hz, external magnetic field < 40 A/m, no DC components, no external conductor with circulating current, conductor centred for measurement, load impedance > 1 MΩ + filter RC 2s.

(2) Out of reference domain

To order	Reference
AC current clamp model MN88 with operating manual	P01120410
AC current clamp model MN89 with operating manual	P01120415



Y series

The Y series clamps are designed to be both rugged and versatile whilst remaining easy to use. The jaws are designed so that the clamps can be hooked onto cables or clamped onto busbars for current measurement up to 600 A AC.

There are two types of Y series clamps available:

The first acts as a current transformer (ratios of 100:1 or 1000:1), giving an output current that may be read by a multimeter, logger or other suitable devices with appropriate current calibres.

The other kind of Y series clamp has a DC voltage output proportional to the AC current measured, allowing instruments without current calibres to measure, display and record currents on a DC voltage calibre.

There is also a model available specifically for direct use with oscilloscopes.

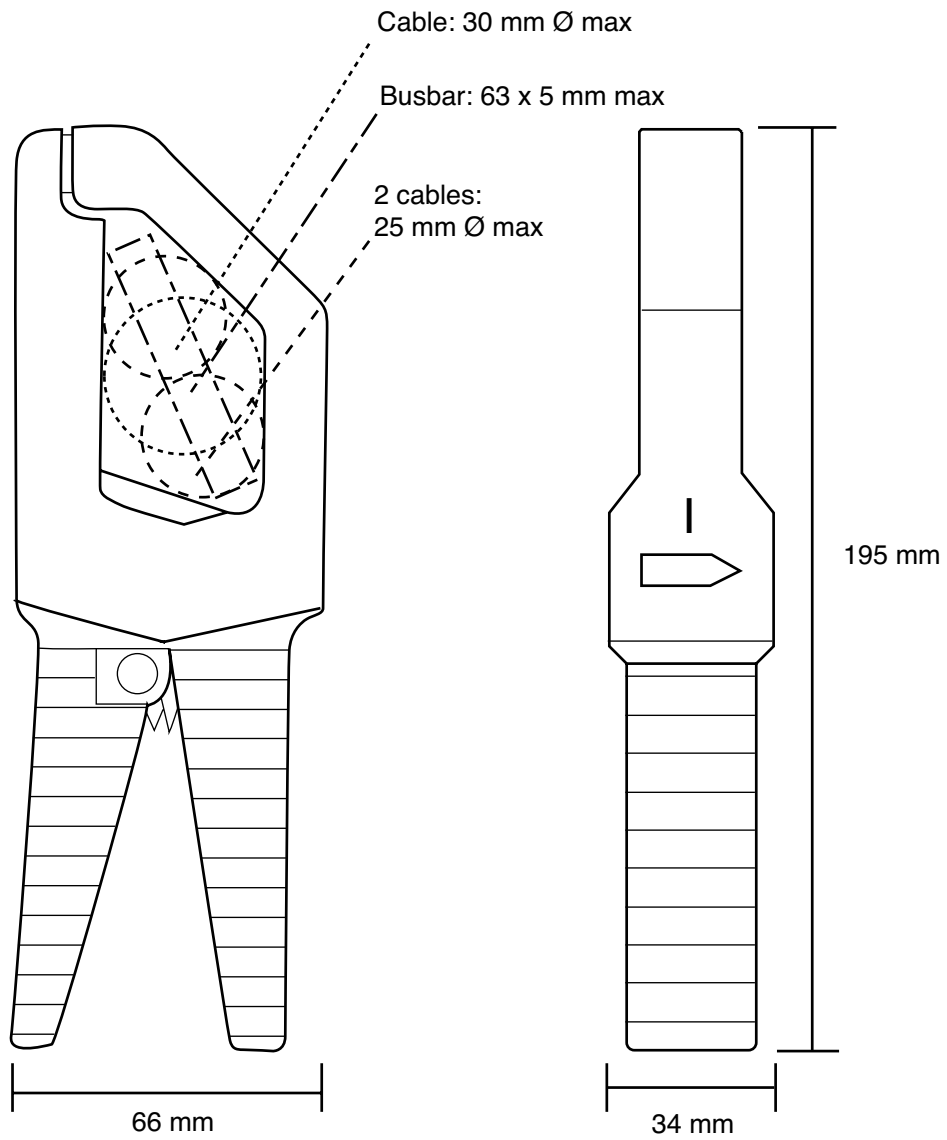

Current clamp for AC current

odel - "n

Y_N series

Current	600 A AC
Ratio	1000/1
Output	1 mA/A

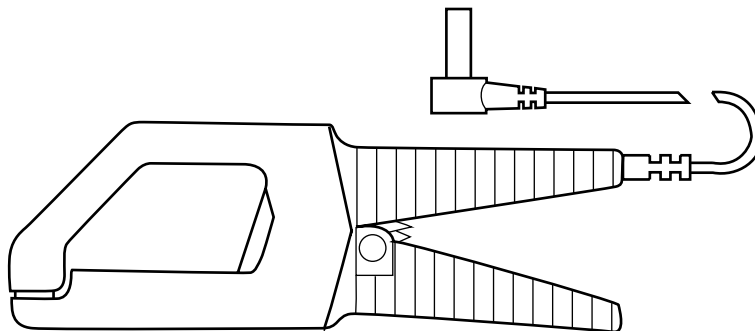

Electrical specifications

Current calibre:
4 A AC ... 600 A AC

Current transformation ratio:
1000:1

Output signal:
1 mA AC/A AC

Accuracy (1):

Primary current	4 A	25 A	100 A	250 A	500 A	600 A (2)
Accuracy in % of output signal	4.5 % + 0.5 mA	4.5 %	3.5 %	3 %	3 %	3 %
Phase shift	not specified	4°	2°	2°	2°	2°

class 3 at 1.25 VA

Bandwidth:

48 Hz ... 1000 Hz

Load impedance:

5 Ω max

Overload:

700 A for 10 minutes

Maximum output voltage (secondary open):

Electronic protection circuit limiting voltage to 10 V peak max.

Operating voltage:

600 V rms

Common mode voltage:

600 V rms

Influence of adjacent and parallel conductors:

< 30 mA/A at 50 Hz

Influence of conductor position in jaws:

±1.5 %

Mechanical specifications

Operating temperature:

-15 °C ... +50 °C

Storage temperature:

-40 °C ... +85 °C

Influence of temperature:

< 0.1 % per 10 °K

Operating altitude:

0 to 2,000 m

Max. jaw opening:

33 mm

Clamping capacity:

Cable: Ø max 30 mm

Busbar: 63 x 5 mm

Casing protection rating:

IP20 in accordance with IEC 529

Drop test:

1.5 m (IEC 68-2-32)

Shock resistance:

100 g, in accordance with IEC 68-2-27

Vibration resistance:

10/55/10 Hz, 0.15 mm test in accordance with IEC 68-2-6

Self-extinguishing capability:

UL94 V0

Dimensions:

66 x 195 x 34 mm

Weight:

420 g

Colour:

Dark grey

Output:

1.5 m two-wire lead with double or reinforced insulation terminated by 2 elbowed male safety plugs (4 mm)

Safety specifications

Electrical safety:

Double or reinforced insulation between the primary and secondary circuits and the outer casing in accordance with IEC 1010-2-032.

- 600 V category III, pollution degree 2
- 300 V category IV, pollution degree 2

Electromagnetic compatibility (EMC):

EN 50081-1: class B

EN 50082-2:

- Electrical discharge: IEC 1000-4-2
- Radial field: IEC 1000-4-3
- Fast transients: IEC 1000-4-4
- Magnetic field at 50/60Hz: IEC 1000-4-8

(1) Conditions of reference: 23 °C ± 5 °K, 20 % to 75 % RH, 48 Hz to 65 Hz, external magnetic field < 40 A/m, no current-carrying conductor nearby, centred test sample, load impedance 5 Ω.

(2) 700 A for 10 minutes max

To order	Reference
AC current clamp model Y1N with operating manual	P01120001A

Current clamp for AC current

odel - "n

Y_N series

Current	600 A AC
Ratio	1000/1
Output	1 mA/A

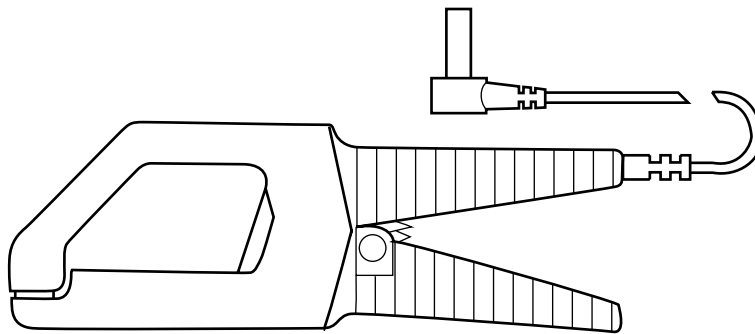

Electrical specifications

Current calibre:
4 A AC ... 600 A AC

Current transformation ratio:
1000:1

Output signal:
1 mA AC/A AC

Accuracy ⁽¹⁾:

Primary current	4 A	25 A	100 A	250 A	500 A	600 A ⁽²⁾
Accuracy in % of output signal	3 % + 0.5 mA	3 %	1.5 %	1 %	1 %	1 %
Phase shift	not specified	3°	1.5°	1°	1°	1°

class 1 at 1.25 VA

Bandwidth:

48 Hz ... 1000 Hz

Load impedance:

5 Ω max

Overload:

700 A for 10 minutes

Max. voltage at output (secondary circuit open):

Electronic protection circuit limiting voltage to 10 V peak max.

Operating voltage:

600 V rms

Common mode voltage:

600 V rms

Influence of adjacent and parallel conductors:

< 30 mA/A at 50 Hz

Influence of conductor position in jaws:

< 1 %

Mechanical specifications

Operating temperature:

-15 °C ... +50 °C

Storage temperature:

-40 °C ... +85 °C

Influence of temperature:

< 0.1 % per 10 °K

Operating altitude:

0 to 2,000 m

Max. jaw opening:

33 mm

Clamping capacity:

Cable: Ø max 30 mm

Busbar: 63 x 5 mm

Casing protection rating:

IP20 in accordance with IEC 529

Drop test:

1.5 m (IEC 68-2-32)

Shock resistance:

100 g, in accordance with IEC 68-2-27

Vibration resistance:

10/55/10 Hz, 0.15 mm test in accordance with IEC 68-2-6

Self-extinguishing capability:

UL94 V0

Dimensions:

66 x 195 x 34 mm

Weight:

420 g

Colour:

Dark grey

Output:

1.5 m two-wire lead with double or reinforced insulation terminated by 2 elbowed male safety plugs (4 mm)

Safety specifications

Electrical safety:

Double or reinforced insulation between the primary and secondary circuits and the outer casing in accordance with IEC 1010-2-032.

- 600 V category III, pollution degree 2

- 300 V category IV, pollution degree 2

Electromagnetic compatibility (EMC):

EN 50081-1: class B

EN 50082-2:

- Electrical discharge IEC 1000-4-2

- Radial field IEC 1000-4-3

- Fast transients IEC 1000-4-4

- Magnetic field at 50/60 Hz IEC 1000-4-8

(1) Conditions of reference: 23 °C ± 5 °K, 20 % to 75 % RH, 48 Hz to 65 Hz, external magnetic field < 40 A/m, no current-carrying conductor nearby, centred test sample, load impedance 5 Ω.

(2) 700 A for 10 minutes max

To order	Reference
AC current clamp model Y2N with operating manual	P01120028A

Current clamp for AC current

odel - n

Y_N series

Current	600 A AC
Ratio	100/1
Output	10 mA/A

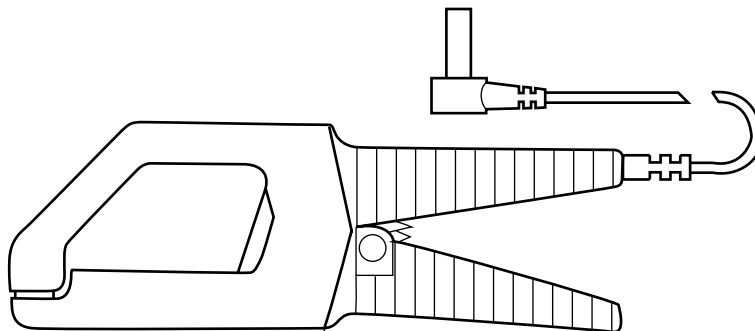

■ Electrical specifications

Current calibre:
4 A AC...600 A AC

Current transformation ratio:
100:1

Output signal:
10 mA AC/A AC

Accuracy ⁽¹⁾:

Primary current	4 A	25 A	100 A	250 A	500 A	600 A ⁽²⁾
Accuracy in % of output signal	5 % + 5 mA	5 %	3 %	3 %	3 %	3 %
Phase shift	not specified	6°	5°	3°	3°	3°

Class 3 at 2.5 VA

Bandwidth:
48 Hz ... 1000 Hz

Load impedance:
0.1 Ω max

Overload:
700 A for 10 minutes

Max. voltage at output (secondary circuit open):
Electronic protection circuit limiting voltage to 10 V peak max.

Operating voltage:
600 V rms

Common mode voltage:
30 V rms

Influence of adjacent and parallel conductors:
< 30 mA/A at 50 Hz

Influence of conductor position in jaws:
±1 %

■ Mechanical specifications

Operating temperature:
-15 °C ... +50 °C

Storage temperature:
-40 °C ... +85 °C

Influence of temperature:
< 0.1 % per 10 °K

Operating altitude:
0 to 2,000 m

Max. jaw opening:
33 mm

Clamping capacity:
Cable: Ø max 30 mm
Busbar: 63 x 5 mm

Casing protection rating:
IP20 in accordance with IEC 529

Drop test:
1.5 m (IEC 68-2-32)

Shock resistance:
100 g, in accordance with IEC 68-2-27

Vibration resistance:
10/55/10 Hz, 0.15 mm test in accordance with IEC 68-2-6

Self-extinguishing capability:
UL94 V0

Dimensions:
66 x 195 x 34 mm

Weight:
420 g

Colour:
Dark grey

Output:
1.5 m two-wire lead with double or reinforced insulation terminated by 2 elbowed male safety plugs (4 mm)

■ Safety specifications

Electrical safety:

Double or reinforced insulation between the primary and secondary circuits and the outer casing in accordance with IEC 1010-2-032.
- 600 V category III, pollution degree 2
- 300 V category IV, pollution degree 2

Electromagnetic compatibility (EMC):

EN 50081-1: class B
EN 50082-2:
- Electrical discharge IEC 1000-4-2
- Radial field IEC 1000-4-3
- Fast transients IEC 1000-4-4
- Magnetic field at 50/60 Hz IEC 1000-4-8

(1) Conditions of reference: 23 °C ± 5 °K, 20 % to 75 % RH, 48 Hz to 65 Hz, external magnetic field < 40 A/m, no current-carrying conductor nearby, centred test sample, load impedance 0.1 Ω.
(2) 700 A for 10 minutes max.

To order	Reference
AC current clamp model Y3N with operating manual	P01120029A

Current clamp for AC current

odel - n

Y_N series

Current	600 A AC
Output	1 mV DC/AAC

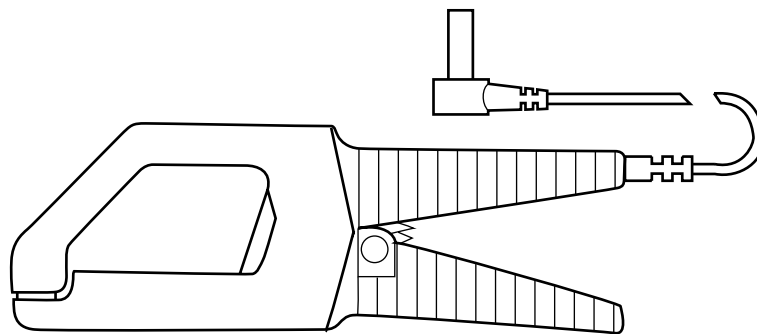

Electrical specifications

Current calibre:
4 A AC ... 600 A AC

Output signal:
1 mV DC/AAC

Accuracy (1):

Primary current	2 A	25 A	100 A	250 A	500 A	600 A (2)
Accuracy in % of output signal	5 % + 0.5 mV DC	5 %	2 %	1 %	1 %	2 %

Bandwidth:
48 Hz ... 1000 Hz
(error: add 2 % to reference)

Load impedance:
> 100 kΩ max

Overload:
700 A for 10 minutes

Operating voltage:
600 V rms

Common mode voltage:
600 V rms

Influence of adjacent and parallel conductors:
< 30 mA/A at 50 Hz

Influence of conductor position in jaws:
±1 %

Drop test:
1.5 m (IEC 68-2-32)

Shock resistance:
100 g, in accordance with IEC 68-2-27

Vibration resistance:
10/55/10 Hz, 0.15 mm test in accordance with IEC 68-2-6

Self-extinguishing capability:
UL94 V0

Dimensions:
66 x 195 x 34 mm

Weight:
420 g

Colour:
Dark grey

Output:
1.5 m two-wire lead with double or reinforced insulation terminated by 2 elbowed male safety plugs (4 mm)

Mechanical specifications

Operating temperature:
-15 °C ... +50 °C

Storage temperature:
-40 °C ... +85 °C

Influence of temperature:
< 0.1 % per 10 °K

Operating altitude:
0 to 2,000 m

Max. jaw opening:
33 mm

Clamping capacity:
Cable: Ø max 30 mm
Busbar: 63 x 5 mm

Casing protection rating:
IP20 in accordance with IEC 529

Safety specifications

Electrical safety:
Double or reinforced insulation between the primary and secondary circuits and the outer casing in accordance with IEC 1010-2-032.
- 600 V category III, pollution degree 2
- 300 V category IV, pollution degree 2

Electromagnetic compatibility (EMC):
EN 50081-1: class B
EN 50082-2:
- Electrical discharge: IEC 1000-4-2
- Radial field: IEC 1000-4-3
- Fast transients: IEC 1000-4-4
- Magnetic field at 50/60 Hz: IEC 1000-4-8

(1) Conditions of reference: 23 °C ± 5 °K, 20 % to 75 % RH, 48 Hz to 65 Hz, external magnetic field < 40 A/m, no current-carrying conductor nearby, centred test sample, load impedance 10 MΩ.
(2) 600 A for 10 minutes max

To order	Reference
AC current clamp model Y4N with operating manual	P01120005A

odel - \bar{n} insulated AC current probe

Current	1200 A peak
Output	1 mV/A

Description

This 500 A AC clamp can be used for the display and measurement of 'current' curves. It comes with a coaxial cable terminated by a BNC plug, thus making it the ideal tool for use with oscilloscopes. It supplies a mV output signal that is directly proportional to the measured current.

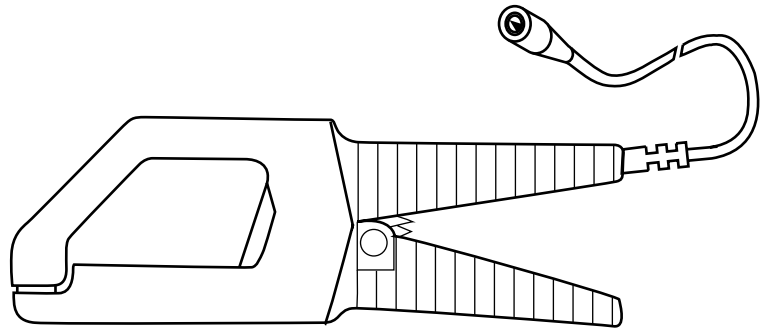

Electrical specifications

Current calibre:

1 A AC ... 500 A AC (1200 A peak)

Output signal:

1 mVAC/A AC (0.5 V for 500 A)

Accuracy and phase shift⁽¹⁾:

Primary current	1 A...20 A	20 A...100 A	100 A...500 A
Accuracy in % of output signal	≤ 5 % + 0.3 mV	≤ 5 %	≤ 2 %
Phase shift	not specified	≤ 3°	≤ 1°

Bandwidth:

5 Hz ... 10 kHz (to -3 dB) (depending on current)

Rise/fall time from 10 % to 90 %:

37 μ s

10 % delay time:

1 μ s

Ampere second product:

10 A.s

Insertion impedance (at 400 Hz / 10 kHz):

< 0.1 m Ω / < 3.1 m Ω

dV/dt:

0.24 mV/ μ s (typical)

Maximum currents:

500 A constant

700 A: 10 minutes operation / 30 minutes shutdown for frequency ≤ 2 kHz (limitation proportional to the inverse of one third of the frequency above that)

Load impedance interne:

≤ 100 Ω / 4.7 nF

Influence of temperature:

≤ 0.15 % of output signal per 10 °K

Influence of adjacent conductor:

≤ 5 μ V / A at 50 Hz

Influence of conductor position in jaws:

≤ 1.5 % + 0.1 AAC

Mechanical specifications

Operating temperature:

-25 °C to +50 °C

Storage temperature:

-40 °C to +80 °C

Relative humidity for operation:

0 to 85 % RH decreasing linearly above 35 °C

Operating altitude:

0 to 2,000 m

Max. jaw opening:

33 mm

Clamping capacity:

Cable: \varnothing max 30 mm
Busbar: 1 busbar of 63 x 5 mm

Casing protection rating:

IP20 (IEC 529)

Drop test:

1.5 m (IEC 68-2-32)

Shock resistance:

100 g / 6 ms / half-period (IEC 68-2-27)

Protection against impacts:

IK04 0.5 J (EN 50102)

Vibration resistance:

10/55/10 Hz 0.15 mm (IEC 68-2-6)

Self-extinguishing capability:

UL94 V0

Dimensions:

195 x 66 x 34 mm

Weight:

420 g

Colour:

Dark grey

Output:

Via 2 m coaxial cable terminated by insulated BNC plug

Safety specifications

Electrical safety:

Instrument with double insulation or reinforced insulation between the primary, the secondary and the grippable part located under the guard as per IEC 1010-1 & IEC 1010-2-032

- 600 V category III, pollution degree 2

- 300 V category IV, pollution degree 2

Electromagnetic compatibility (EMC):

EN 50081-1: class B

EN 50082-2:

- Electrostatic discharge: IEC 1000-4-2

4 kV level 2 performance criterion B

8 kV in the air level 3 performance criterion B

- Radiated field: IEC 1000-4-3

10 V/m performance criterion A

- Fast transients: IEC 1000-4-4

1 kV level 2 performance criterion B

2 kV level 3 performance criterion B

- Magnetic field at 50/60 Hz: IEC 1000-4-8

field of 400 A/m at 50 Hz: < 1 A

oscilloscope clamp for AC current

odel - n insulated AC current probe

Curves

Error on measurement at 50 Hz

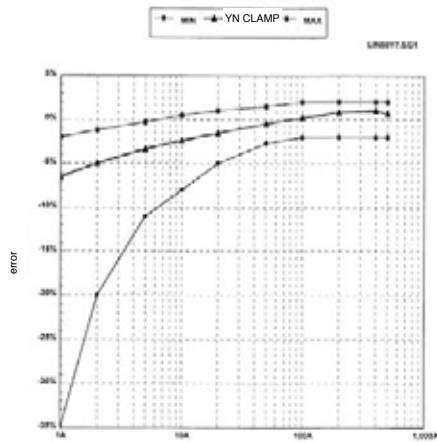

Phase shift at 50 Hz

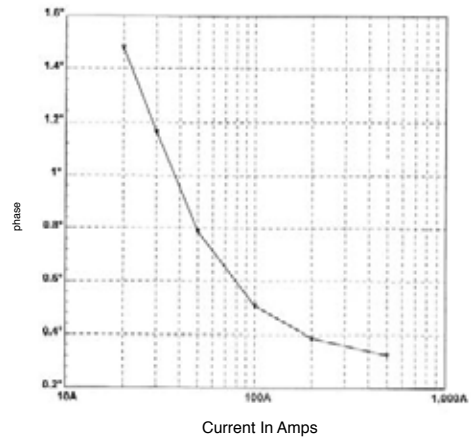

Frequency response

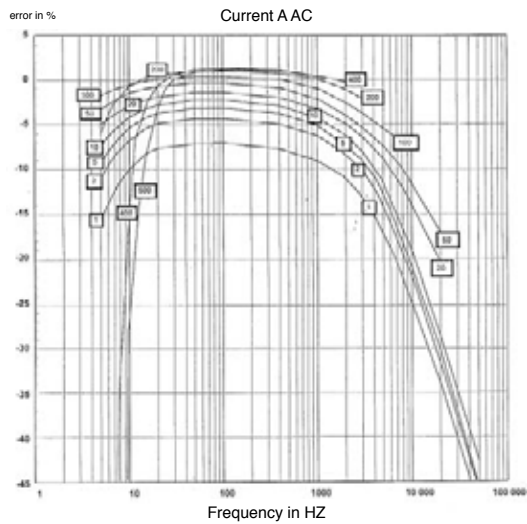

Phase shift according to frequency

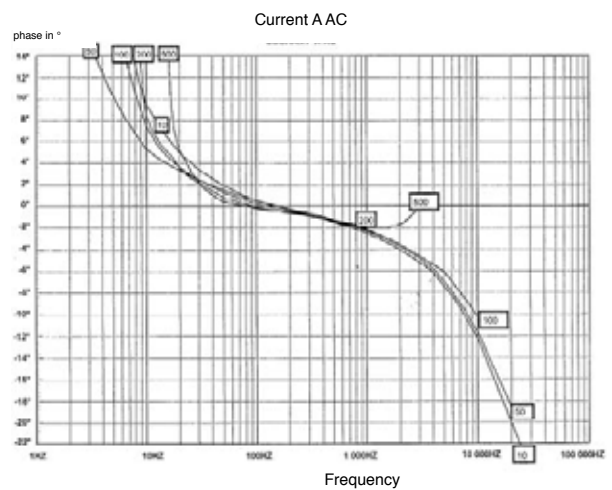

Influence of frequency and derating

Frequency Hz	5 Hz to 10 Hz	10 Hz to 20 Hz	20 Hz to 45 Hz	65 Hz to 3 kHz	3 kHz to 6 kHz	6 kHz to 10 kHz
1 A to 200 A	15 %					
> 200 A	not spec.					
1 A to 300 A		5 %				
300 A to 400 A		15 %				
400 A to 500 A		25 %				
1 A to 500 A			5 %			
1 A to 50 A				5 % + 0.4 A		
50 A to 500 A				5 %		
> 500 A				not spec.		
1 A to 100 A					15 % + 0.4 A	
> 100 A					not spec.	
1 A to 50 A						-3 dB
> 50 A						not spec.

- Error in % of reading: not spec. means not specified
 - Do not exceed 500 A for measurement with constant operation, and for the derating, use the formula $500(A) \cdot 2 / F(kHz)$ to calculate the maximum current in A AC, in constant use, depending on the frequency in kHz.

Influence of DC current

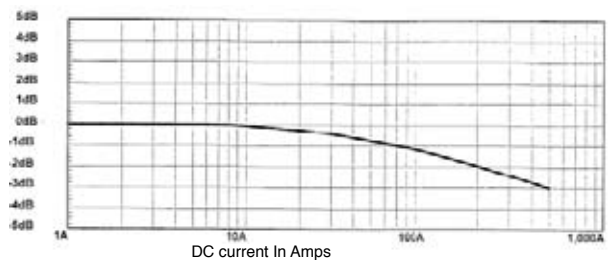

Oscilloscope clamp for AC current

odel - n insulated AC current probe

YN series

■ Response to a square signal

5 A at 10 Hz

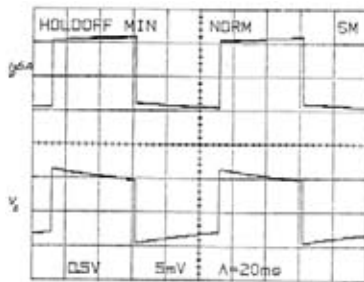

5 A at 50 Hz

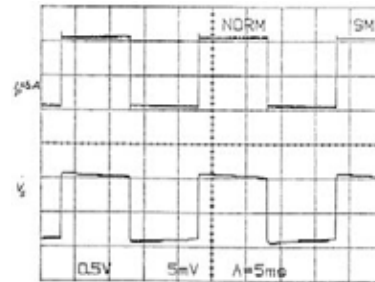

5 A at 500 Hz

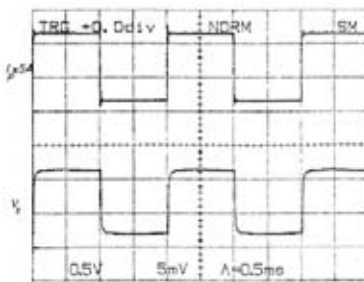

5 A at 4 kHz

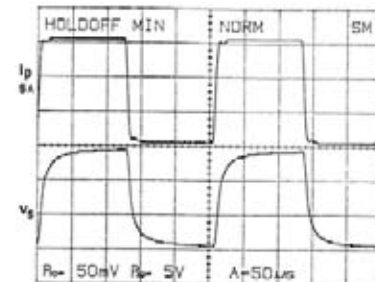

■ Response to a step

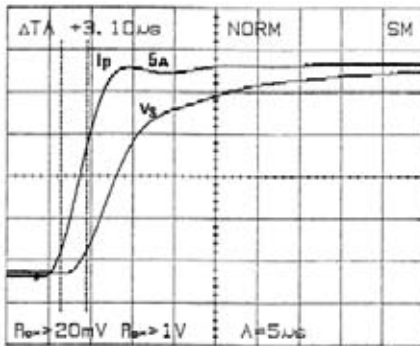

(1) Conditions of reference: 23 °C ± 3 °K, 20 % to 75 % RH, sinusoidal signal with frequency of 48 Hz at 1 kHz, external magnetic field < 40 A/m, no DC components, no external conductor with circulating current, conductor centred for measurement, load impedance >1 MΩ / < 100 pF.

To order	Reference
AC current clamp model Y7N for oscilloscope with operating manual	P01120075



"C100" series

The "C100" series is a range of thirteen transformer clamps with all the advantages of our old "C30" series clamps whilst incorporating considerable improvements, particularly in the field of safety, ergonomics and performance:

1000 A measurement, excellent metrology, high accuracy, high level of linearity, symmetrical coil windings for minimum phase shift, pendular adjusting system for magnetic elements, maximum conductor diameter \varnothing 52 mm and also some models with μ metal core specially made for wattmeter use.

Innovative design: excellent ergonomics, handle with finger grips, assisted opening system for jaws (patented system).

IEC 1010 600 V cat. III safety (industry and services), anti-slip protection, conductor anti-pinching system,...

All this technology and manufacturing quality has been combined to provide the best measurement possible without any complications.

A "C100" series clamp is compatible with any instrument (multimeter, wattmeter, recorder, oscilloscope...) for safe measurement of AC currents without shutting down the installation.

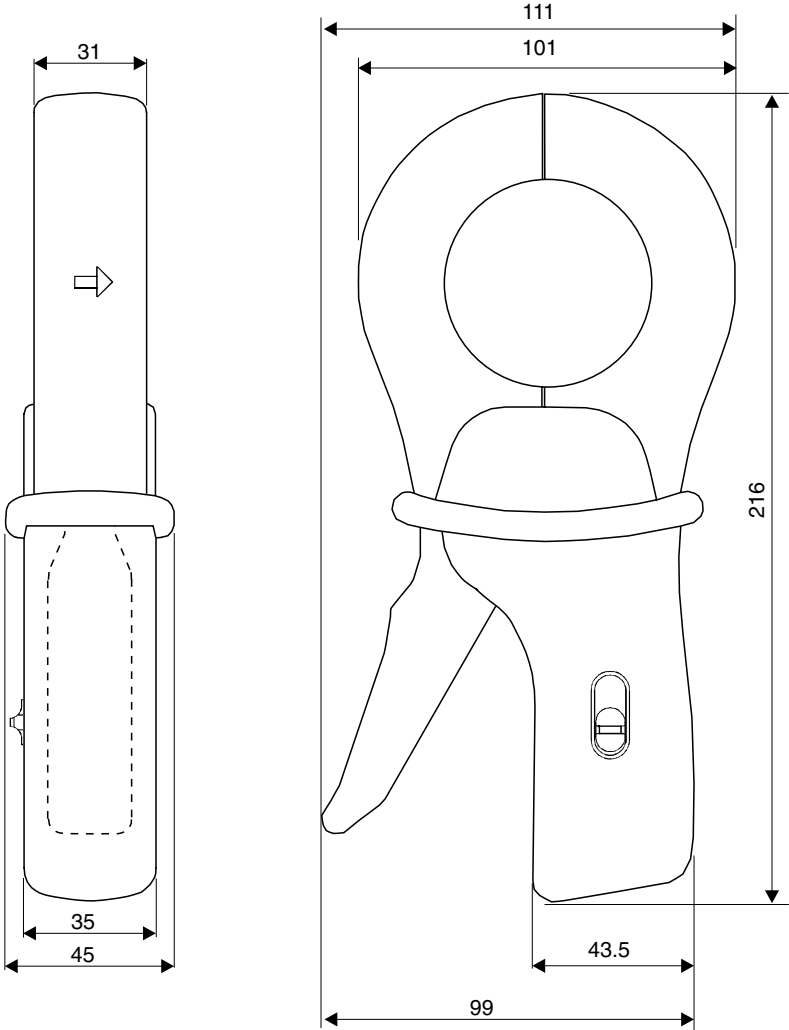

Current clamp for AC current odel C¹⁰⁰

C100 series

Current	1000 A
Ratio	1000/1
Output	1 mA/A

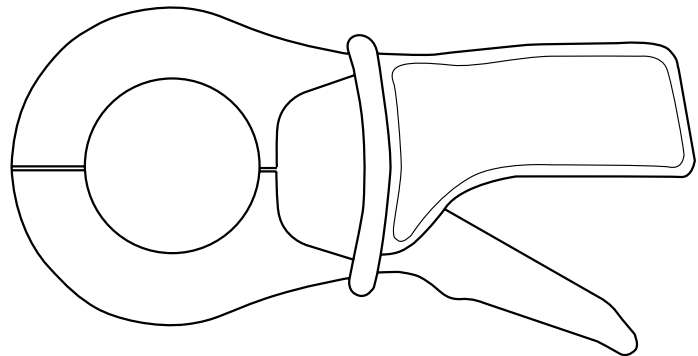

Electrical specifications

Current calibre:

0.1 A AC ... 1200 A AC

Current transformation ratio:

1000:1

Output signal:

1 mA AC/A AC (1 A to 1000 A)

Accuracy and phase shift ⁽¹⁾:

Primary current	0.1 A...10 A	10 A	50 A ⁽²⁾	200 A ⁽²⁾	1000 A ⁽²⁾	1200 A ⁽²⁾
Accuracy in % of output signal	≤ 3 % + 0.1 mA	≤ 3 %	≤ 1.5 %	≤ 0.75 %	≤ 0.5 %	≤ 0.5 %
Phase shift	not specified	≤ 3°	≤ 1.5°	≤ 0.75°	≤ 0.5°	≤ 0.5°

Bandwidth:

30 Hz ... 10 kHz (-3 dB)

Crest factor:

≤ 6 for a current ≤ 3000 A peak (500 Arms)

Maximum currents:

1000 A continuous for a frequency ≤ 1 kHz (limitation proportional to the inverse frequency beyond)

1200 A for 40 minutes max. (interval between measurements > 20 minutes)

Load impedance:

≤ 15 Ω

Operating voltage:

600 V rms

Common mode voltage:

600 V category III and pollution degree 2

Influence of adjacent conductor:

≤ 1 mA/A at 50 Hz

Influence of conductor position in jaws:

≤ 0.1 % of output signal for frequencies ≤ 400 Hz

Load influence:

from 5 Ω to 15 Ω

< 0.5 % on measurement

< 0.5° on phase

Influence of frequency ⁽³⁾:

< 1 % of output signal from 30 Hz ... 48 Hz

< 0.5 % of output signal from 65 Hz ... 1 kHz

< 1 % of output signal from 1 kHz ... 5 kHz

Influence of crest factor:

< 1 % of output signal for crest factor ≤ 6 with current ≤ 3000 A peak (500 Arms)

Influence of DC current superimposed on rated current:

< 1 % of output signal for a current ≤ 30 A DC

Mechanical specifications

Operating temperature:

-10 °C to +50 °C

Storage temperature:

-40 °C to +70 °C

Influence of temperature:

≤ 0.1 % of output signal per 10 °K

Relative humidity for operation:

0 to 85 % RH decreasing linearly above 35 °C

Influence of relative humidity:

< 0.1 % of output signal from 10 % to 85 % RH

Operating altitude:

0 to 2,000 m

Max. jaw opening:

53 mm

Patented progressive opening system

Clamping capacity:

Cable: Ø max 52 mm

Busbar: 1 busbar of 50 x 5 mm / 4 busbars of 30 x 5 mm

Casing protection rating:

IP40 (IEC 529)

Drop test:

1 m (IEC 68-2-32)

Shock resistance:

100 g (IEC 68-2-27)

Vibration resistance:

5/15 Hz 1.5 mm

15/25 Hz 1 mm

25/55 Hz 0.25 mm

(IEC 68-2-6)

Self-extinguishing capability:

Casing and jaws: UL94 V0

Dimensions:

216 x 111 x 45 mm

Weight:

550 g

Colours:

Dark grey case with red jaws

Output:

Safety sockets (4 mm)

Safety specifications

Electrical safety:

Instrument with double insulation or reinforced insulation between the primary, the secondary and the grippable part located under the guard as per IEC 1010-1 & IEC 1010-2-032

- 600 V category III, pollution degree 2

- 300 V category IV, pollution degree 2

Electromagnetic compatibility (EMC):

EN 50081-1: class B

EN 50082-2:

- Electrostatic discharge: IEC 1000-4-2

- Radiated field: IEC 1000-4-3

- Fast transients: IEC 1000-4-4

- Magnetic field at 50/60 Hz: IEC 1000-4-8

(1) Conditions of reference: 23 °C ± 3 °K, 20 % to 75 % RH, sine signal, frequency of 48 Hz to 65 Hz, distortion factor < 1 %, no DC components, external magnetic field < 40 A/m, no AC magnetic field, conductor centred for measurement, load impedance 5 Ω (5 VA)

(2) Accuracy class in accordance with IEC 185: 5 VA - class 0.5 - 48 Hz ... 65 Hz

(3) Out of frequency domain

To order	Reference
AC current clamp model C100 with operating manual	P01120301

Current clamps for AC current models C102 and C103

C100 series

Current	1000 A
Ratio	1000/1
Output	1 mA/A

Description

An electronic voltage limiter protects the output of the clamp, if the secondary circuit is opened accidentally.

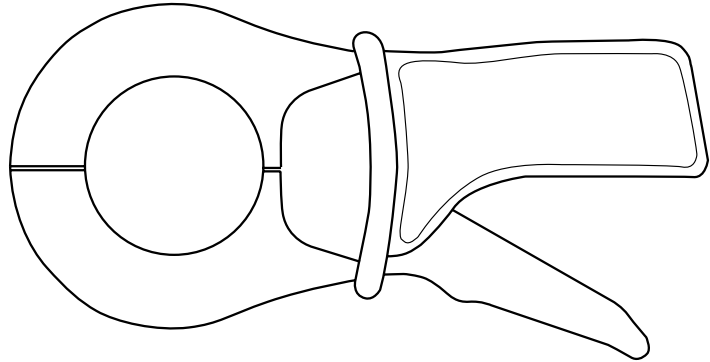

Electrical specifications

Current calibre:

0.1 A AC ... 1200 A AC

Current transformation ratio:

1000:1

Output signal:

1 mA AC/A AC (1 A for 1000 A)

Accuracy and phase shift⁽¹⁾:

Primary current	0.1 A...10 A	10 A	50 A ⁽²⁾	200 A ⁽²⁾	1000 A ⁽²⁾	1200 A ⁽²⁾
Accuracy in % of output signal	≤ 3 % + 0.1 mA	≤ 3 %	≤ 1.5 %	≤ 0.75 %	≤ 0.5 %	≤ 0.5 %
Phase shift	not specified	≤ 3°	≤ 1.5°	≤ 0.75°	≤ 0.5°	≤ 0.5°

Bandwidth:

30 Hz ... 10 kHz (-3 dB)

Crest factor:

≤ 6 for a current ≤ 3000 A peak (500 Arms)

Maximum currents:

1000 A continuous for a frequency ≤ 1 kHz (limitation proportional to the inverse frequency beyond)

1200 A for 40 minutes max. (interval between measurements > 20 minutes)

Load impedance:

≤ 15 Ω

Max. voltage output:

Electronic limiter 30 V max. peak

Operating voltage:

600 V rms

Common mode voltage:

600 V category III and pollution degree 2

Influence of adjacent conductor:

≤ 1 mA/A at 50 Hz

Influence of conductor position in jaws:

≤ 0.1 % of output signal for frequencies ≤ 400 Hz

Load influence:

from 5 Ω to 15 Ω

< 0.5 % on measurement

< 0.5° on phase

Influence of frequency⁽³⁾:

< 1 % of output signal from 30 Hz ... 48 Hz

< 0.5 % of output signal from 65 Hz ... 1 kHz

< 1 % of output signal from 1 kHz ... 5 kHz

Influence of crest factor:

< 1 % of output signal for crest factor ≤ 6 with current ≤ 3000 A peak (500 A rms)

Influence of DC current superimposed on rated current:

< 1 % of output signal for a current ≤ 30 A DC

Mechanical specifications

Operating temperature:

-10 °C to +50 °C

Storage temperature:

-40 °C to +70 °C

Influence of temperature:

≤ 0.1 % of output signal per 10 °K

Relative humidity for operation:

0 to 85 % RH with a linear decrease above 35 °C

Influence of relative humidity:

< 0.1 % of output signal from 10 % to 85 % RH

Operating altitude:

0 to 2,000 m

Max. jaw opening:

53 mm, patented progressive opening system

Clamping capacity:

Cable: Ø max 52 mm

Busbar: 1 busbar of 50 x 5 mm / 4 busbars of 30 x 5 mm

Casing protection rating:

IP40 (IEC 529)

Drop test:

1 m (IEC 68-2-32)

Shock resistance:

100 g (IEC 68-2-27)

Vibration resistance:

5/15 Hz 1.5 mm - 15/25 Hz 1 mm - 25/55 Hz 0.25 mm (IEC 68-2-6)

Self-extinguishing capability:

Casing and jaws: UL94 V0

Dimensions:

216 x 111 x 45 mm

Weight:

550 g

Colours:

Dark grey case with red jaws

Output:

C102: safety sockets (4 mm)

C103: two-wire cable with reinforced insulation or double insulation, length 1.5 m, terminated by 2 insulated elbowed male banana plugs, Ø 4 mm

Safety specifications

Electrical safety:

Instrument with double insulation or reinforced insulation between the primary, the secondary and the grippable part located under the guard as per IEC 1010-1 & IEC 1010-2-032

- 600 V category III, pollution degree 2

- 300 V category IV, pollution degree 2

Electromagnetic compatibility (EMC):

EN 50081-1: class B

EN 50082-2:

- Electrostatic discharge: IEC 1000-4-2

- Radiated field: IEC 1000-4-3

- Fast transients: IEC 1000-4-4

- Magnetic field at 50/60 Hz: IEC 1000-4-8

(1) Conditions of reference: 23 °C ± 3 °K, 20 % to 75 % RH, sine signal, frequency of 48 Hz to 65 Hz, distortion factor < 1 %, no DC components, external magnetic field < 40 A/m, no AC magnetic field, conductor centred for measurement, load impedance 5 Ω (5 VA).

(2) Accuracy class in accordance with IEC 185: 5 VA - class 0.5 - 48 ... 65 Hz.

(3) Out of reference domain.

To order	Reference
AC current clamp model C102 with operating manual	P01120302
AC current clamp model C103 with operating manual	P01120303

Current clamps for AC current models C¹⁰⁶ and C¹⁰⁷

C100 series

Current	1000 A
Output	1 mV/A

Electrical specifications

Current calibre:

0.1 A AC...1200 A AC

Output signal:

1 mVAC/A AC (1 V for 1000 A)

Accuracy and phase shift ⁽¹⁾:

Primary current	0.1 A...10 A	10 A	50 A	200 A	1000 A	1200 A
% Accuracy of output signal	≤ 3 % + 0.1 mV	≤ 3 %	≤ 1.5 %	≤ 0.75 %	≤ 0.5 %	≤ 0.5 %
Phase shift	not specified	≤ 3°	≤ 1.5°	≤ 0.75°	≤ 0.5°	≤ 0.5°

Bandwidth:

30 Hz ...10 kHz

Crest factor:

≤ 6 for a current ≤ 3000 A peak (500 Arms)

Maximum currents:

1000 A continuous for a frequency ≤ 1 kHz (limitation proportional to the inverse frequency beyond)

1200 A for 40 minutes max. (interval between measurements > 20 minutes)

Output impedance:

1 Ω ± 1 %

Load impedance:

≥ 1 MΩ and ≤ 100 pF

Operating voltage:

600 V rms

Common mode voltage:

600 V category III and pollution degree 2

Influence of adjacent conductor:

≤ 1 μV/A at 50 Hz

Influence of conductor position in jaws:

≤ 0.1 % of output signal for frequencies ≤ 400 Hz

Load influence:

On receiver, for an input impedance of 100 Ω: ≤ 1 % on measurement, no measurement on phase.

On receiver, for an input impedance of 1 kΩ: ≤ 0.1 % on measurement, no measurement on phase

Influence of frequency ⁽²⁾:

< 1 % of output signal from 30 Hz ...48 Hz

< 0.5 % of output signal from 65 Hz ...1 kHz

< 1 % of output signal from 1 kHz ...5 kHz

Influence of crest factor:

< 1 % of output signal for crest factor ≤ 6 with current ≤ 3000 A peak (500 Arms)

Influence of DC current superimposed on rated current:

< 1 % of output signal for a current ≤ 30 A DC

Mechanical specifications

Operating temperature:

-10 °C to +50 °C

Storage temperature:

-40 °C to +70 °C

Influence of temperature:

≤ 0.1 % of output signal per 10 °K

Relative humidity for operation:

0 to 85 % RH decreasing linearly above 35 °C

Influence of relative humidity:

< 0.1 % of output signal from 10 % to 85 % RH

Operating altitude:

0 to 2,000 m

Max. jaw opening:

53 mm

Patented progressive opening system

Clamping capacity:

Cable: Ø max 52 mm

Busbar: 1 busbar of 50 x 5 mm / 4 busbars of 30 x 5 mm

Casing protection rating:

IP40 (IEC 529)

Drop test:

1 m (IEC 68-2-32)

Shock resistance:

100 g (IEC 68-2-27)

Vibration resistance:

5/15 Hz 1.5 mm

15/25 Hz 1 mm

25/55 Hz 0.25 mm

(IEC 68-2-6)

Self-extinguishing capability:

Casing and jaws: UL94 V0

Dimensions:

216 x 111 x 45 mm

Weight:

550 g

Colours:

Dark grey case with red jaws

Output:

C106: safety sockets (4 mm)

C107: two-wire cable with reinforced insulation or double insulation, length 1.5 m, terminated by 2 insulated elbowed male banana plugs, Ø 4 mm

Safety specifications

Electrical safety:

Instrument with double insulation or reinforced insulation between the primary, the secondary and the grippable part located under the guard as per IEC 1010-1 & IEC 1010-2-032

- 600 V category III, pollution degree 2

- 300 V category IV, pollution degree 2

Electromagnetic compatibility (EMC):

EN 50081-1: class B

EN 50082-2:

- Electrostatic discharge: IEC 1000-4-2

- Radiated field: IEC 1000-4-3

- Fast transients: IEC 1000-4-4

- Magnetic field at 50/60 Hz: IEC 1000-4-8

(1) Conditions of reference: 23 °C ± 3 °K, 20 % to 75 % RH, sine signal, frequency of 48 Hz to 65 Hz, distortion factor < 1 %, no DC components, external magnetic field < 40 A/m, no AC magnetic field, conductor centred for measurement.

(2) Out of reference domain.

To order	Reference
AC current clamp model C106 with operating manual	P01120304
AC current clamp model C107 with operating manual	P01120305

Current clamps for AC current models C112 and C113

C100 series

Current	1000 A
Ratio	1000/1
Output	1 mA/A

Description

Thanks to their excellent technical performance (phase shift and linearity), these μ -metal core clamps are highly recommended for wattmeter use. These clamps are protected at output against overvoltages.

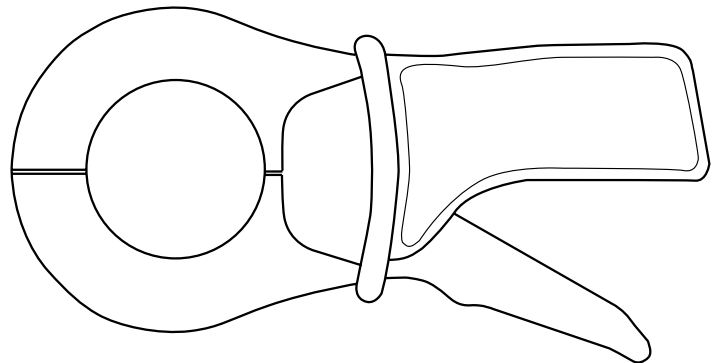

Electrical specifications

Current calibre:

0.001 A AC ... 1200 A AC

Current transformation ratio:

1000:1

Output signal:

1 mA AC/A AC (1 A for 1000 A)

Accuracy and phase shift⁽¹⁾:

Primary current	0.1 A...100 mA	0.1 A...1 A	1 A...10 A	10 A...100 A	100 A...1200 A
% Accuracy of output signal	$\leq 3\% + 5 \mu\text{A}$	$\leq 2\% + 3 \mu\text{A}$	$\leq 1\%$	$\leq 0.5\%$	$\leq 0.3\%$
Phase shift	not specified	not specified	$\leq 2^\circ$	$\leq 1^\circ$	$\leq 0.7^\circ$

Bandwidth:

30 Hz ... 10 kHz

Crest factor:

≤ 6 for a current ≤ 2000 A peak (300 Arms)

Maximum currents:

1000 A continuous for a frequency ≤ 1 kHz (limitation proportional to the inverse frequency beyond)
1200 A for 40 minutes max. (interval between measurements > 20 minutes)

Load impedance:

$\leq 1 \Omega$

Max. voltage output:

Electronic limiter 30 V max. peak

Operating voltage:

600 V rms

Common mode voltage:

600 V category III and pollution degree 2

Influence of adjacent conductor:

≤ 0.5 mA/A at 50 Hz

Influence of conductor position in jaws:

$\leq 0.1\%$ of output signal for frequencies ≤ 400 Hz

Load influence:

from 1 Ω to 5 Ω
 $< 0.1\%$ on measurement
 $< 0.2^\circ$ on phase

Influence of frequency⁽²⁾:

$< 0.5\%$ of output signal from 30 Hz ... 48 Hz
 $< 1\%$ of output signal from 65 Hz ... 1 kHz
 $< 2\%$ of output signal from 1 kHz ... 5 kHz

Influence of crest factor:

$< 1\%$ of output signal for crest factor ≤ 6 with current ≤ 2000 A peak (300 A rms)

Influence of DC current superimposed on rated current:

$< 1\%$ of output signal for a current ≤ 15 A DC

Mechanical specifications

Operating temperature:

-10 $^\circ\text{C}$ to +50 $^\circ\text{C}$

Storage temperature:

-40 $^\circ\text{C}$ to +70 $^\circ\text{C}$

Influence of temperature:

$\leq 0.2\%$ of output signal per 10 $^\circ\text{K}$

Relative humidity for operation:

0 to 85 % RH with a linear decrease above 35 $^\circ\text{C}$

Influence of relative humidity:

$< 0.1\%$ of output signal from 10 % to 85 % RH

Operating altitude:

0 to 2,000 m

Max. jaw opening:

53 mm, patented progressive opening system

Clamping capacity:

Cable: \varnothing max 52 mm
Busbar: 1 busbar of 50 x 5 mm / 4 busbars of 30 x 5 mm

Casing protection rating:

IP40 (IEC 529)

Drop test:

1 m (IEC 68-2-32)

Shock resistance:

100 g (IEC 68-2-27)

Vibration resistance:

5/15 Hz 1.5 mm, 15/25 Hz 1 mm, 25/55 Hz 0.25 mm (IEC 68-2-6)

Self-extinguishing capability:

Casing and jaws: UL94 V0

Dimensions:

216 x 111 x 45 mm

Weight:

550 g

Colours:

Dark grey case with red jaws

Output:

C112: safety sockets (4 mm)
C113: two-wire cable with reinforced insulation or double insulation, length 1.5 m, terminated by 2 insulated elbowed male banana plugs, \varnothing 4 mm

Safety specifications

Electrical safety:

Instrument with double insulation or reinforced insulation between the primary, the secondary and the grippable part located under the guard as per IEC 1010-1 & IEC 1010-2-032
- 600 V category III, pollution degree 2
- 300 V category IV, pollution degree 2

Electromagnetic compatibility (EMC):

EN 50081-1: class B
EN 50082-2:
- Electrostatic discharge: IEC 1000-4-2
- Radiated field: IEC 1000-4-3
- Fast transients: IEC 1000-4-4
- Magnetic field at 50/60 Hz: IEC 1000-4-8

(1) Conditions of reference: 23 $^\circ\text{C} \pm 3^\circ\text{K}$, 20 % to 75 % RH, sine signal, frequency of 48 Hz to 65 Hz, distortion factor $< 1\%$, no DC components, external magnetic field < 40 A/m, no AC magnetic field, conductor centred for measurement, 1 Ω load (1 VA)

(2) Out of reference domain.

To order	Reference
AC current clamp model C112 with operating manual	P01120314
AC current clamp model C113 with operating manual	P01120315

Current clamps for AC current models C116 and C117

C100 series

Current	1000 A
Output	1 mV/A

Description

Thanks to their excellent technical performance (phase shift and linearity), these μ -metal core clamps are highly recommended for wattmeter use.

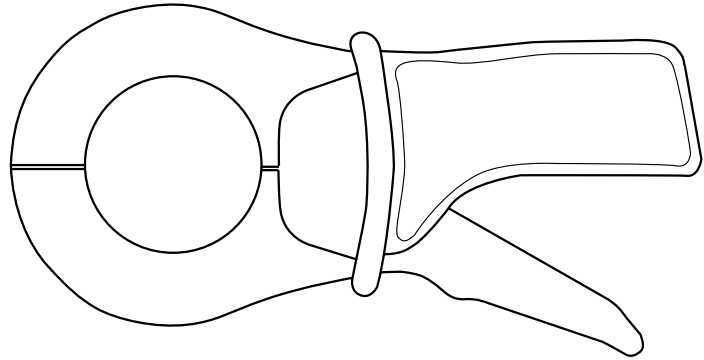

Electrical specifications

Current calibre:

0.001 A AC ... 1200 A AC

Output signal:

1 mVAC/A AC (1 V for 1000 A)

Accuracy and phase shift⁽¹⁾:

Primary current	1 mA...100 mA	0.1 A...1 A	1 A...10 A	10 A...100 A	100 A...1200 A
Accuracy in % of output signal	$\leq 3\% + 5 \mu A$	$\leq 2\% + 3 \mu A$	$\leq 1\%$	$\leq 0.5\%$	$\leq 0.3\%$
Phase shift	not specified	not specified	$\leq 2^\circ$	$\leq 1^\circ$	$\leq 0.7^\circ$

Bandwidth:

30 Hz ... 10 kHz

Crest factor:

≤ 6 for a current ≤ 2000 A peak (300 Arms)

Maximum currents:

1000 A continuous for a frequency ≤ 1 kHz (limitation proportional to the inverse frequency beyond)

1200 A for 40 minutes max. (interval between measurements > 20 minutes)

Output impedance:

$1 \Omega \pm 1\%$

Load impedance:

$\geq 1 \text{ M}\Omega$ and $\leq 100 \text{ pF}$

Operating voltage:

600 V rms

Common mode voltage:

600 V category III and pollution degree 2

Influence of adjacent conductor:

≤ 0.5 mA/A at 50 Hz

Influence of conductor position in jaws:

$\leq 0.1\%$ of output signal for frequencies ≤ 400 Hz

Load influence:

On receiver, for an input impedance of 100Ω : $\leq 1\%$ on measurement, no measurement on phase

On receiver, for an input impedance of $1 \text{ k}\Omega$: $\leq 0.1\%$ on measurement, no measurement on phase

Influence of frequency⁽²⁾:

$< 0.5\%$ of output signal from 30 Hz ... 48 Hz

$< 1\%$ of output signal from 65 Hz ... 1 kHz

$< 2\%$ of output signal from 1 kHz ... 5 kHz

Influence of crest factor:

$< 1\%$ of output signal for crest factor ≤ 6 with current ≤ 2000 A peak

Influence of DC current superimposed on rated current:

$< 1\%$ of output signal for a current ≤ 15 A DC

Mechanical specifications

Operating temperature:

-10°C to $+50^\circ\text{C}$

Storage temperature:

40°C to $+70^\circ\text{C}$

Influence of temperature:

$\leq 0.2\%$ of output signal per 10°C

Relative humidity for operation:

0 to 85 % RH decreasing linearly above 35°C

Influence of relative humidity:

$< 0.1\%$ of output signal from 10 % to 85 % RH

Operating altitude:

0 to 2,000 m

Max. jaw opening:

53 mm, patented progressive opening system

Clamping capacity:

Cable: \varnothing max 52 mm

Busbar: 1 busbar of 50×5 mm / 4 busbars of 30×5 mm

Casing protection rating:

IP40 (IEC 529)

Drop test:

1 m (IEC 68-2-32)

Shock resistance:

100 g (IEC 68-2-27)

Vibration resistance:

5/15 Hz 1.5 mm

15/25 Hz 1 mm

25/55 Hz 0.25 mm

(IEC 68-2-6)

Self-extinguishing capability:

Casing and jaws: UL94 V0

Dimensions:

216 x 111 x 45 mm

Weight:

550 g

Colours:

Dark grey case with red jaws

Output:

C116: safety sockets (4 mm)

C117: two-wire cable with reinforced insulation or double insulation, length 1.5 m, terminated by 2 insulated elbowed male banana plugs, \varnothing 4 mm

Safety specifications

Electrical safety:

Instrument with double insulation or reinforced insulation between the primary, the secondary and the grippable part located under the guard as per IEC 1010-1 & IEC 1010-2-032

- 600 V category III, pollution degree 2

- 300 V category IV, pollution degree 2

Electromagnetic compatibility (EMC):

EN 50081-1: class B

EN 50082-2:

- Electrostatic discharge: IEC 1000-4-2

- Radiated field: IEC 1000-4-3

- Fast transients: IEC 1000-4-4

- Magnetic field at 50/60 Hz: IEC 1000-4-8

(1) Conditions of reference: $23^\circ\text{C} \pm 3^\circ\text{K}$, 20 % to 75 % RH, sine signal, frequency of 48 Hz to 65 Hz, distortion factor $< 1\%$, no DC components, external magnetic field < 40 A/m, no AC magnetic field, conductor centred for measurement, load impedance $\geq 1 \text{ M}\Omega$ and $\leq 100 \text{ pF}$

(2) Out of reference domain

To order	Reference
AC current clamp model C116 with operating manual	P01120316
AC current clamp model C117 with operating manual	P01120317

Clamp on ammeter for AC current model C122

C100 series

Current	1000 A
Ratio	1000/5
Output	5 mA/A

Description

An electronic voltage-limiting system protects output of clamp when operating, if the secondary circuit is opened accidentally.

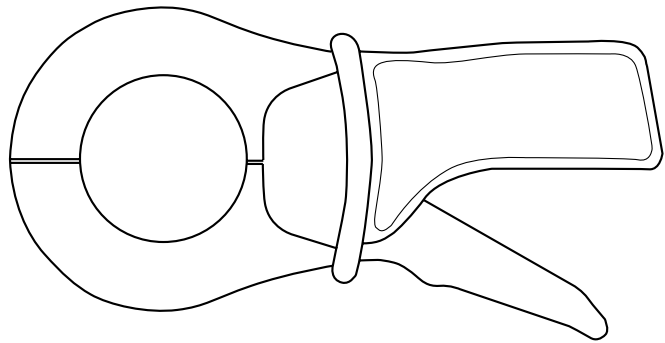

Electrical specifications

Current calibre:

1 AAC ... 1200 AAC

Current transformation ratio:

1000:5

Output signal:

5 mA AC/AAC (5 A for 1000 A)

Accuracy and phase shift ⁽¹⁾:

Primary current	1 A...20 A	20 A	50 A ⁽²⁾	200 A ⁽²⁾	1000 A ⁽²⁾	1200 A ⁽²⁾
Accuracy in %	≤ 6 % + 0.5 mA	≤ 5 %	≤ 3 %	≤ 1.5 %	≤ 1 %	≤ 1 %
Phase shift	not specified	≤ 3°	≤ 3°	≤ 1.5°	≤ 1°	≤ 1°

Bandwidth:

30 Hz ... 10 kHz

Crest factor:

≤ 6 for a current ≤ 3000 A peak (500 Arms)

Maximum currents:

1000 A continuous for a frequency ≤ 1 kHz (limitation proportional to the inverse frequency beyond)

1200 A for 30 minutes max (interval between measurements > 15 minutes)

Load impedance:

≤ 0.6 Ω

Impedance of connection leads:

≤ 40 mΩ

Max. voltage at output (secondary circuit open):

Electronic limiter 30 V max. peak

Operating voltage:

600 V rms

Common mode voltage:

600 V category III and pollution degree 2

Influence of adjacent conductor:

≤ 1 mA/A at 50 Hz

Influence of conductor position in jaws:

≤ 0.2 % of output signal for frequencies ≤ 400 Hz

Load influence:

from 0.2 Ω to 0.6 Ω

< 0.5 % on measurement

< 0.5° on phase

Influence of frequency ⁽³⁾:

< 1 % of output signal from 30 Hz ... 48 Hz

< 0.5 % of output signal from 65 Hz ... 1 kHz

< 1 % of output signal from 1 kHz ... 5 kHz

Influence of crest factor:

< 1 % of output signal for crest factor ≤ 6 with current ≤ 3000 A peak (500 Arms)

Influence of DC current superimposed on rated current:

< 1 % of output signal for a current ≤ 30 A DC

Mechanical specifications

Operating temperature:

-10 °C to +50 °C

Storage temperature:

-40 °C to +70 °C

Influence of temperature:

≤ 0.1 % of output signal per 10 °K

Relative humidity for operation:

0 to 85 % RH with a linear decrease above 35 °C

Influence of relative humidity:

< 0.2 % of output signal from 10 % to 85 % RH

Operating altitude:

0 to 2,000 m

Max. jaw opening:

53 mm, patented progressive opening system

Clamping capacity:

- Cable: Ø max 52 mm

- Busbar: 1 busbar of 50 x 5 mm / 4 busbars of 30 x 5 mm

Casing protection rating:

IP40 (IEC 529)

Drop test:

1 m (IEC 68-2-32)

Shock resistance:

100 g (IEC 68-2-27)

Vibration resistance:

5/15 Hz 1.5 mm

15/25 Hz 1 mm

25/55 Hz 0.25 mm

(IEC 68-2-6)

Self-extinguishing capability:

Casing and jaws: UL94 V0

Dimensions:

216 x 111 x 45 mm

Weight:

550 g

Colours:

Dark grey case with red jaws

Output:

Safety sockets (4 mm)

Safety specifications

Electrical safety:

Instrument with double insulation or reinforced insulation between the primary, the secondary and the grippable part located under the guard as per IEC 1010-1 & IEC 1010-2-032

- 600 V category III, pollution degree 2

- 300 V category IV, pollution degree 2

Electromagnetic compatibility (EMC):

EN 50081-1: class B

EN 50082-2:

- Electrostatic discharge: IEC 1000-4-2

- Radiated field: IEC 1000-4-3

- Fast transients: IEC 1000-4-4

- Magnetic field at 50/60 Hz: IEC 1000-4-8

(1) Conditions of reference: 23 °C ± 3 °K, 20 % to 75 % RH, sine signal, frequency of 48 Hz to 65 Hz, distortion factor < 1 %, no DC components, external magnetic field < 40 A/m, no AC magnetic field, conductor centred for measurement, load impedance 0.2 Ω (5 VA)

(2) Accuracy class in accordance with IEC 185: 5 VA - class 1 - 48 ... 65 Hz

(3) Out of reference domain

To order	Reference
AC current clamp model C122 with operating manual	P01120306

Current clamp for AC current odel C[®]

C100 series

Current	250 A AC	500 A AC	1000 A AC
Ratio	250:5	500:5	1000:5
Output	20 mA/A	10 mA/A	5 mA/A

Description

An electronic voltage-limiting system protects output of clamp when operating if the secondary circuit is opened accidentally.

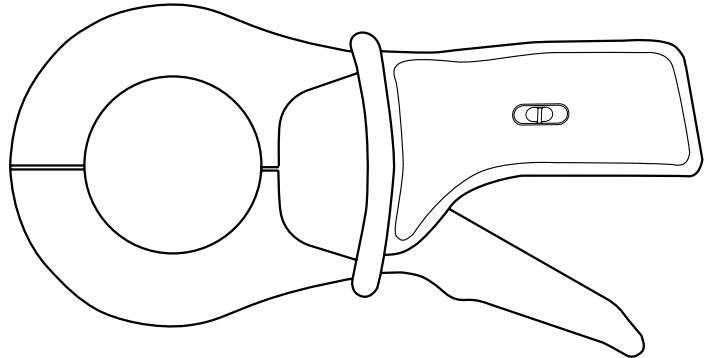

Electrical specifications

Current calibres:

1 A AC...300 A AC
1 A AC...600 A AC
1 A AC...1200 A AC

Current transformation ratio

250:5
500:5
1000:5

Output signal:

20 mA AC/A AC (5 A for 250 A)
10 mA AC/A AC (5 A for 500 A)
5 mA AC/A AC (5 A for 1000 A)

Accuracy and phase shift ⁽¹⁾:

250 A calibre

Primary current	1 A...5 A	5 A	12.5 A ⁽²⁾	50 A ⁽²⁾	250 A ⁽²⁾	300 A ⁽²⁾
Accuracy in %	≤ 10 % + 2 mA	≤ 10 %	≤ 5 %	≤ 2.5 %	≤ 2 %	≤ 2 %
Phase shift	not specified	not specified	≤ 10°	≤ 10°	≤ 10°	≤ 10°

500 A calibre

Primary current	1 A...10 A	10 A	25 A ⁽³⁾	100 A ⁽³⁾	500 A ⁽³⁾	600 A ⁽³⁾
Accuracy in %	≤ 6 % + 1 mA	≤ 6 %	≤ 3 %	≤ 2 %	≤ 1 %	≤ 1 %
Phase shift	not specified	≤ 6°	≤ 4°	≤ 3°	≤ 2.5°	≤ 2.5°

1000 A calibre

Primary current	1 A...20 A	20 A	50 A ⁽⁴⁾	200 A ⁽⁴⁾	1000 A ⁽⁴⁾	1200 A ⁽⁴⁾
Accuracy in %	≤ 6 % + 0.5 mA	≤ 5 %	≤ 3 %	≤ 1.5 %	≤ 1 %	≤ 1 %
Phase shift	not specified	≤ 5°	≤ 3°	≤ 1.5°	≤ 1°	≤ 1°

Bandwidth:

48 Hz...1 kHz

Crest factor:

250 A calibre:
≤ 6 with current ≤ 750 A peak
500 A calibre:
≤ 6 with current ≤ 1500 A peak
1000 A calibre:
≤ 6 with current ≤ 3000 A peak

Maximum currents:

1200 A for frequencies ≤ 1 kHz for 30 minutes max. (interval between measurements > 15 minutes)

Load impedance:

250 A calibre: ≤ 0.2 Ω
500 A calibre: ≤ 0.4 Ω
1000 A calibre: ≤ 0.4 Ω

Impedance of connection leads:

≤ 40 mΩ

Max. voltage at output (secondary circuit open):

Electronic limiter 30 V max. peak

Operating voltage:

600 V rms

Common mode voltage:

600 V category III and pollution degree 2

Influence of adjacent conductor:

250 A calibre: ≤ 15 mA/A at 50 Hz
500 A calibre: ≤ 10 mA/A at 50 Hz
1000 A calibre: ≤ 1 mA/A at 50 Hz

Influence of conductor position in jaws:

for frequencies ≤ 400 Hz

250 A calibre: ≤ 0.6 % of output signal
500 A calibre: ≤ 0.4 % of output signal
1000 A calibre: ≤ 0.2 % of output signal

Load influence:

250 A calibre: from 25 mΩ to 0.2 Ω
< 2 % on measurement
< 4° on phase

500 A calibre: from 50 mΩ to 0.4 Ω
< 1 % on measurement
< 2° on phase

1000 A calibre: from 50 mΩ to 0.4 Ω
< 0.5 % on measurement
< 0.5° on phase

Influence of frequency ⁽⁵⁾:

250 A calibre:
< 1 % of output signal from 65 Hz...100 Hz
< 5 % of output signal from 100 Hz...1 kHz

500 A calibre:
< 1 % of output signal from 65 Hz...1 kHz

1000 A calibre:
< 0.5 % of output signal from 65 Hz...100 Hz
< 1 % of output signal from 100 Hz...1 kHz

Influence of crest factor:

< 1 % of output signal for crest factor ≤ 6 with current:
≤ 750 A peak (250 A calibre)
≤ 1500 A peak (500 A calibre)
≤ 3000 A peak (1000 A calibre)

Influence of DC current superimposed on rated current:

< 1 % of output signal for a current ≤ 30 A DC

Current clamp for AC current odel C¹⁴⁸

C100 series

■ Mechanical specifications

Operating temperature:

-10 °C to +50 °C

Storage temperature:

-40 °C to +70 °C

Influence of temperature:

≤ 0.15 % of output signal per 10 °K

Relative humidity for operation:

0 to 85 % RH decreasing linearly above 35 °C

Influence of relative humidity:

10 % to 85 % RH

250 A calibre:

< 0.6 % of output signal and < 2° on phase

500 A calibre:

< 0.4 % of output signal and < 0.6° on phase

1000 A calibre:

< 0.2 % of output signal and < 0.2° on phase

Operating altitude:

0 to 2,000 m

Max. jaw opening:

53 mm

Patented progressive opening system

Clamping capacity:

Cable: Ø max 52 mm

Busbar: 1 busbar of 50 x 5 mm / 4 busbars of 30 x 5 mm

Casing protection rating:

IP40 (IEC 529)

Drop test:

1 m (IEC 68-2-32)

Shock resistance:

100 g (IEC 68-2-27)

Vibration resistance:

5/15 Hz 1.5 mm

15/25 Hz 1 mm

25/55 Hz 0.25 mm

(IEC 68-2-6)

Self-extinguishing capability:

UL94 V0

Dimensions:

216 x 111 x 45 mm

Weight:

550 g

Colours:

Dark grey case with red jaws

Output:

Safety sockets (4 mm)

■ Safety specifications

Electrical safety:

Instrument with double insulation or reinforced insulation between the primary, the secondary and the grippable part located under the guard as per IEC 1010-1 & IEC 1010-2-032

- 600 V category III, pollution degree 2

- 300 V category IV, pollution degree 2

Electromagnetic compatibility (EMC):

EN 50081-1: class B

EN 50082-2:

- Electrostatic discharge: IEC 1000-4-2

- Radiated field: IEC 1000-4-3

- Fast transients: IEC 1000-4-4

- Magnetic field at 50/60 Hz: IEC 1000-4-8

(1) Conditions of reference: 23 °C ± 3 °K, 20 % to 75 % RH, sine signal, frequency of 48 Hz to 65 Hz, distortion factor < 1 %, external magnetic field < 40 A/m, no AC magnetic field, conductor centred for measurement, load impedance:

- 250 A calibre: 0.1 Ω (2.5 VA)

- 500 A calibre: 0.2 Ω (5 VA)

- 1000 A calibre: 0.2 Ω (5 VA)

(2) Accuracy class in accordance with IEC 185: 2.5 VA - class 3 - 48-65 Hz

(3) Accuracy class in accordance with IEC 185: 5 VA - class 3 - 48-65 Hz

(4) Accuracy class in accordance with IEC 185: 5 VA - class 1 - 48-65 Hz

(5) Out of reference domain

To order	Reference
AC current clamp model C148 with operating manual	P01120307

odel C^o insulated AC current probe

Current	30 A peak	300 A peak	2000 A peak
Output	100 mV/A	10 mV/A	1 mV/A

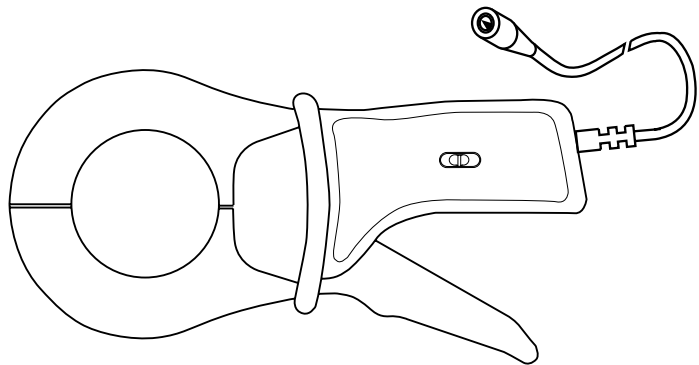

Description

This 1,000 A AC clamp can be used for easy display and measurement of current curves. Equipped with a coaxial cable terminated by a BNC connector, it is ideal for use with any oscilloscope. It outputs a signal in mV directly proportional to the current. It offers 3 different sensitivities.

Electrical specifications

Current calibres:

0.1 A AC...10 A AC (30 A peak)
 1 A AC...100 A AC (300 A peak)
 1 A AC...1000 A AC (2000 A peak)

Output signal:

100 mVAC/AAC (1 V for 10 A)
 10 mVAC/AAC (1 V for 100 A)
 1 mAAC/AAC (1 V for 1000 A)

Accuracy and phase shift ⁽¹⁾:

10 A calibre

Primary current	0.1 A...0.5 A	0.5 A...2 A	2 A...10 A	10 A...12 A
% Accuracy of output signal	≤ 3 % + 10 mV	≤ 3 % + 10 mV	≤ 3 % + 10 mV	≤ 3 % + 10 mV
Phase shift	not specified	not specified	≤ 15°	≤ 15°

100 A calibre

Primary current	0.1 A...5 A	5 A...20 A	20 A...100 A	100 A...120 A
% Accuracy of output signal	≤ 2 % + 5 mV	≤ 2 % + 5 mV	≤ 2 % + 5 mV	≤ 2 % + 5 mV
Phase shift	not specified	≤ 15°	≤ 10°	≤ 5°

1000 A calibre

Primary current	1 A...50 A	50 A...200 A	200 A...1000 A	1000 A...1200 A
% Accuracy of output signal	≤ 1 % + 1 mV	≤ 1 % + 1 mV	≤ 1 % + 1 mV	≤ 1 % + 1 mV
Phase shift	not specified	≤ 3°	≤ 2°	≤ 1°

Bandwidth:

10 Hz...100 kHz (-3 dB) (depending on current value)

Rise/fall time from 10 % to 90 %:

3.5 μs

10 % delay time:

0.5 μs

Ampere second product:

10 A calibre: 3.2 A.s
 100 A calibre: 26 A.s
 1000 A calibre: 64 A.s

Maximum currents:

1000 A permanent
 1200 A for 40 minutes max. / > 20 minutes shutdown for a frequency ≤ 1 kHz (limitation proportional to the inverse of one third of the frequency beyond that)

Insertion impedance (at 400 Hz / 10 kHz)

10 A calibre: < 0.3 mΩ / < 6,6 mΩ
 100 A calibre: < 0.3 mΩ / < 2 mΩ
 1000 A calibre: < 0.3 mΩ / < 1.6 mΩ

Output impedance at 1 kHz:

10 A calibre: ≤ 515 Ω ± 10 %
 100 A calibre: ≤ 515 Ω ± 10 %
 1000 A calibre: ≤ 515 Ω ± 10 %

Influence of temperature:

≤ 150 ppm /k or 0.15 % of output signal per 10 °K

Influence of relative humidity:

< 0.1 % of output signal

Influence of adjacent conductor:

≤ 1 mA/A at 50 Hz

Influence of DC current superimposed on rated current:

< 1 % of output signal for a current ≤ 30 A DC

Influence of conductor position in jaws:
 ≤ 0.1 % of output signal for frequencies ≤ 400 Hz

Influence of frequency ⁽²⁾:

10 A calibre:

< 10 % of output signal from 10 Hz to 1 kHz
 < 5 % of output signal from 1 kHz to 10 kHz
 < 20 % of output signal from 10 kHz to 50 kHz
 3 dB of output signal from 50 kHz to 100 kHz

100 A calibre:

< 5 % of output signal from 10 Hz to 1 kHz
 < 3 % of output signal from 1 kHz to 10 kHz
 < 20 % of output signal from 10 kHz to 50 kHz
 3 dB of output signal from 50 kHz to 100 kHz

1000 A calibre:

< 1 % of output signal from 10 Hz to 1 kHz
 < 2 % of output signal from 1 kHz to 10 kHz
 < 10 % of output signal from 10 kHz to 50 kHz
 3 dB of output signal from 50 kHz to 100 kHz

Influence of crest factor:

< 1 % of output signal for crest factor ≤ 6 with current

10 A calibre: ≤ 30 A peak
 100 A calibre: ≤ 300 A peak
 1000 A calibre: ≤ 3000 A peak

oscilloscope clamp for AC current

odel C[®] insulated AC current probe

C100 series

■ Mechanical specifications

Max. jaw opening:
53 mm

Clamping capacity:

Cable: Ø max 52 mm

Busbar: 1 busbar of 50 x 5 mm / 4 busbars of 30 x 5 mm

Operating temperature:

-10 °C to +55 °C

Storage temperature:

-40 °C to +70 °C

Relative humidity for operation:

0 to 85 % RH decreasing linearly above 35 °C

Operating altitude:

0 to 2,000 m

Casing protection rating:

IP30 with clamp open (IEC 529)

IP40 with clamp closed (IEC 529)

Drop test:

1 m (IEC 68-2-32)

Shock resistance:

100 g / 6 ms / half-period (IEC 68-2-27)

Protection against impacts:

IK04 0.5 J (EN 50102)

Vibration resistance:

5/15 Hz 1.5 mm peak

15/25 Hz 1 mm peak

25/55 Hz 0.25 mm peak

(IEC 68-2-6)

Self-extinguishing capability:

Casing and jaws: UL94 V0

Dimensions:

216 x 111 x 45 mm

Weight:

550 g

Colours:

Dark grey case with red jaws

Output:

2 m coaxial lead with insulated BNC plug

■ Safety specifications

Electrical safety:

Instrument with double insulation or reinforced insulation between the primary, the secondary and the grippable part located under the guard as per IEC 1010-1 & IEC 1010-2-032

- 600 V category III, pollution degree 2

- 300 V category IV, pollution degree 2

Electromagnetic compatibility (EMC):

EN 50081-1: class B

EN 50082-2:

- Electrostatic discharge: IEC 1000-4-2

without disturbance: 4 kV class 2

non-destructive: 15 kV class 4

- Radiated field: IEC 1000-4-3

without disturbance: 10 V/m performance criterion A

- Fast transients: IEC 1000-4-4

without disturbance: 1 kV class 2

non-destructive: 2 kV class 3

- Magnetic field at 50/60 Hz: IEC 1000-4-8

field of 400 A/m at 50 Hz: < 1 A

(1) Conditions of reference: 23 °C ± 3 °K, 20 % to 75 % RH, sine signal, frequency of 48 Hz to 1000 Hz, distortion factor < 1 % with no DC component, external magnetic field < 40 A/m, no DC components, no external conductor with circulating current, conductor centred for measurement, load impedance: ≥ 1 MΩ and < 100 pF

(2) Out of reference domain

To order	Reference
AC current clamp model C160 with operating manual	P01120308

oscilloscope clamp for AC current

odel C⁴ insulated AC current probe

C100 series

Curves at 50 Hz

1000 A calibre

Error on measurement

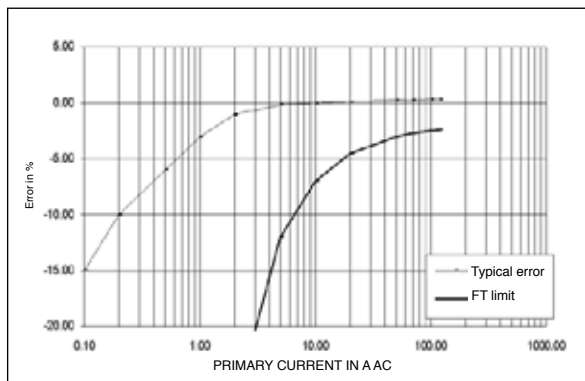

Phase shift

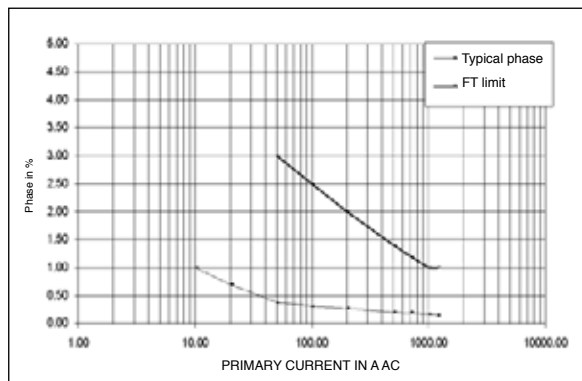

100 A calibre

Error on measurement

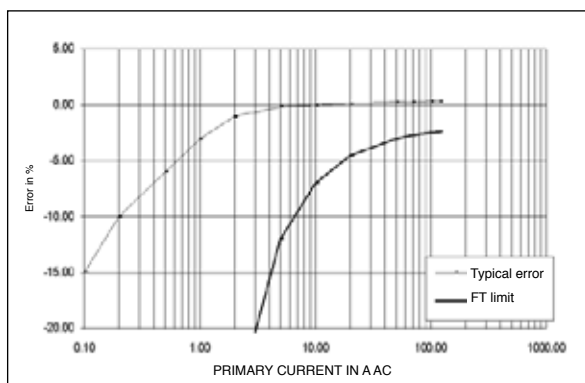

Phase shift

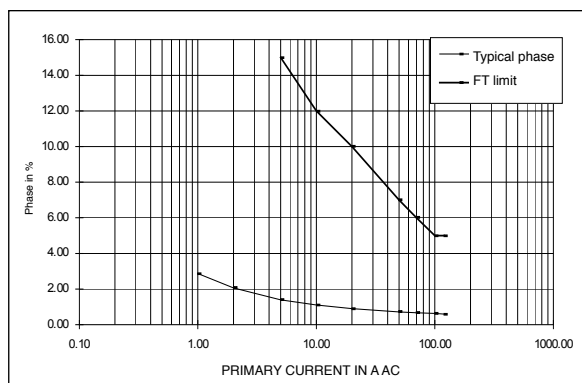

10 A calibre

Error on measurement

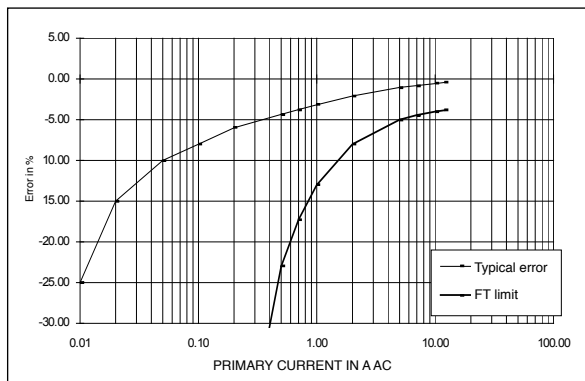

Phase shift

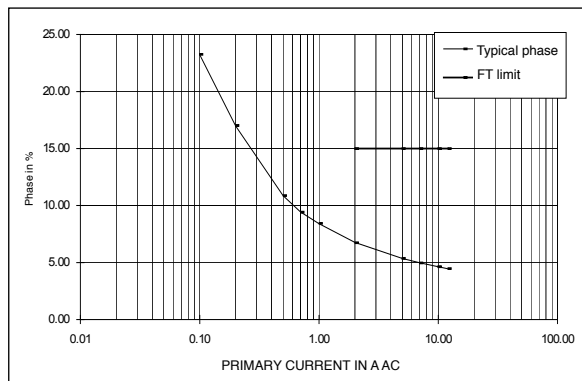

oscilloscope clamp for AC current

odel C⁴ insulated AC current probe

C100 series

Frequency response (cont.)

1000 A calibre

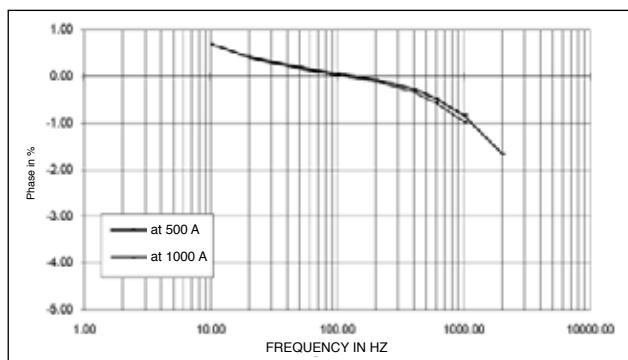
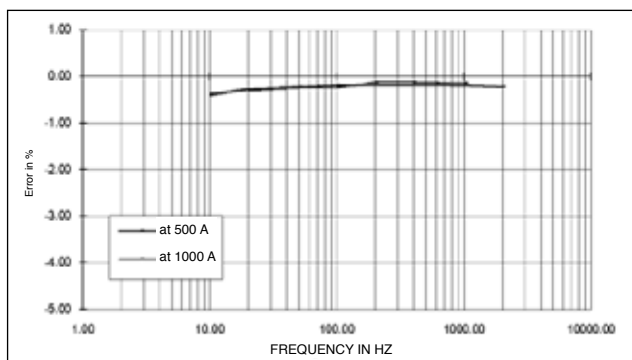
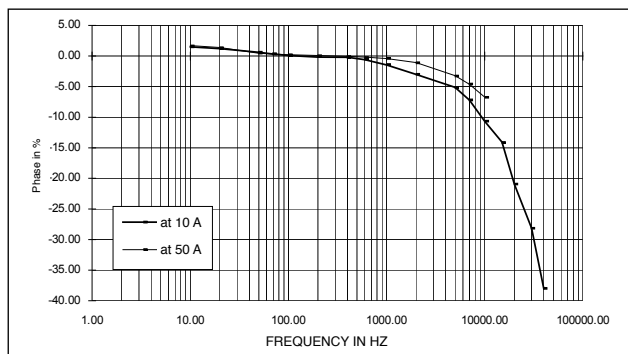
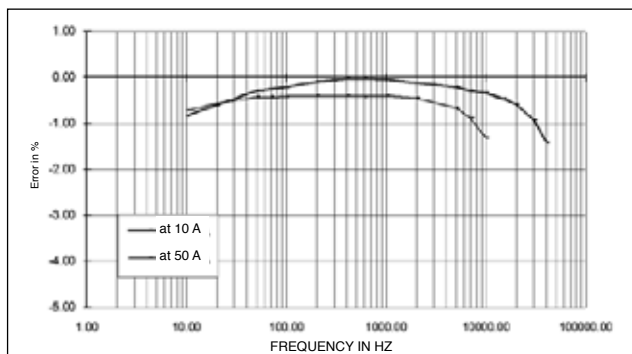

100 A calibre

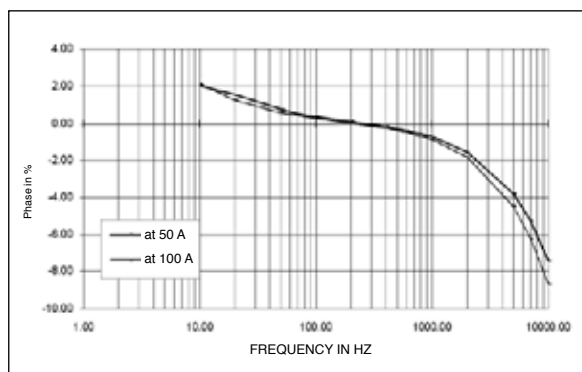
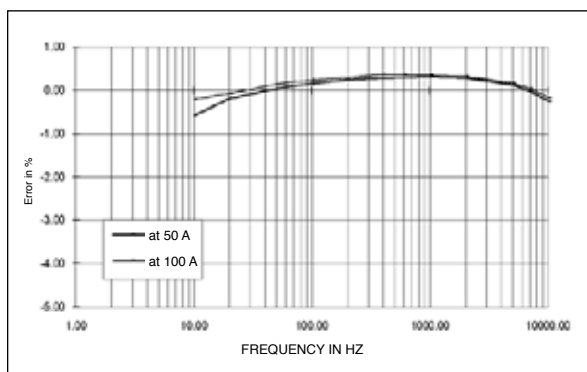
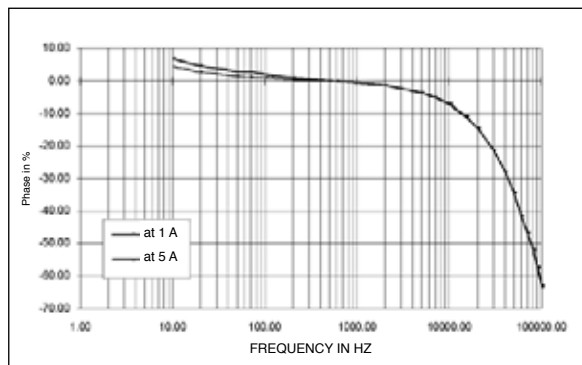
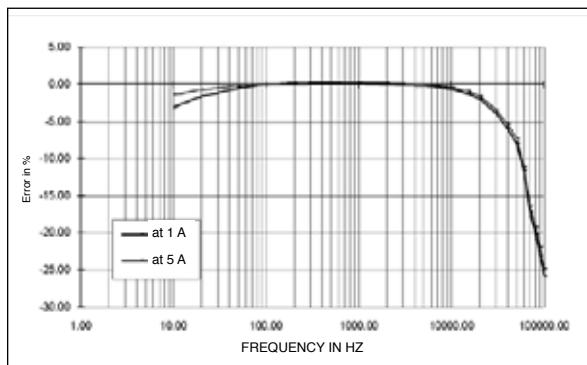

oscilloscope clamp for AC current

odel C⁴ insulated AC current probe

C100 series

Frequency response (cont.)

10 A calibre

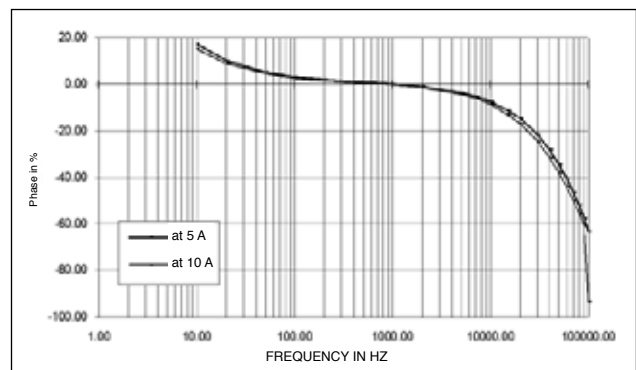
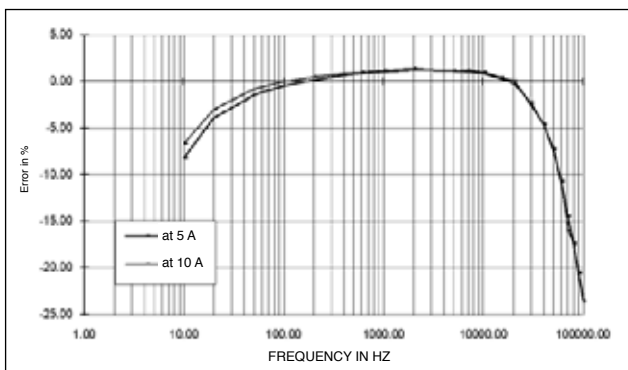
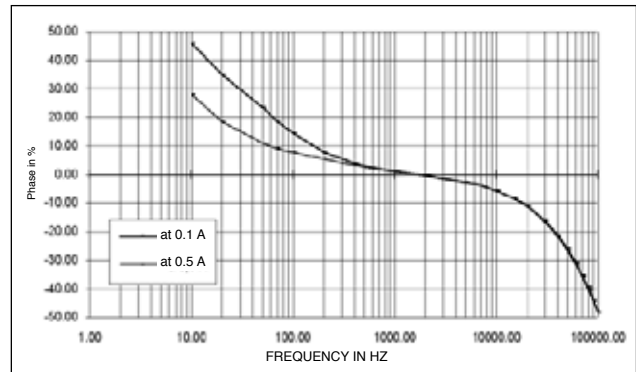
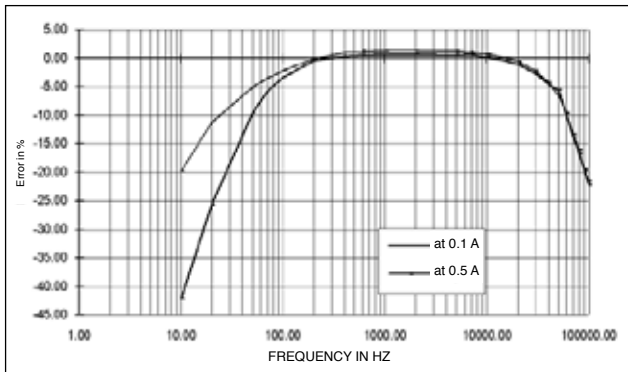

Response to a square signal

1000 A calibre

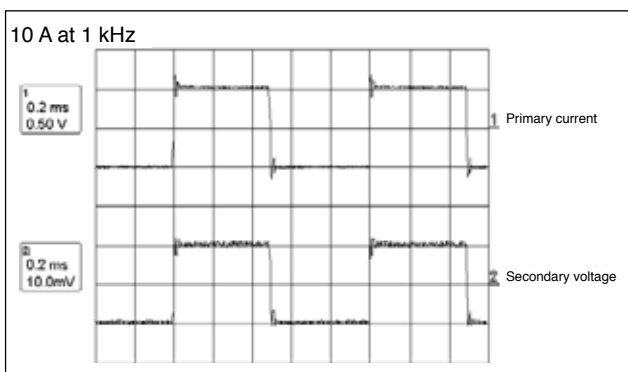
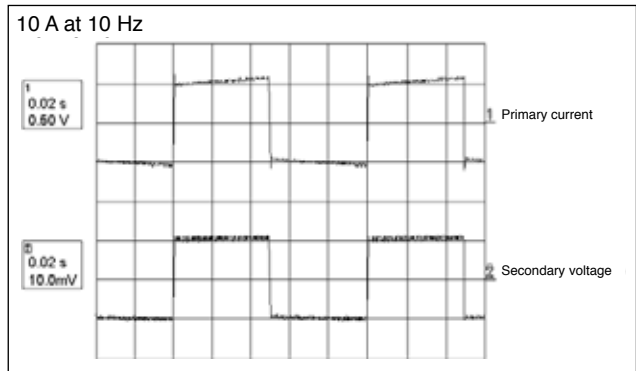
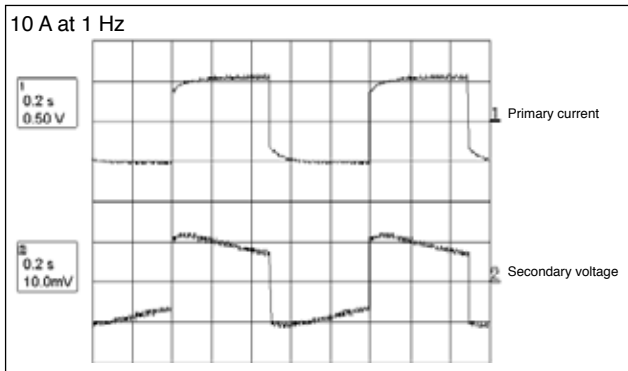

Oscilloscope clamp for AC current

odel C⁴ insulated AC current probe

C100 series

■ Response to a square signal (cont.)

100 A calibre

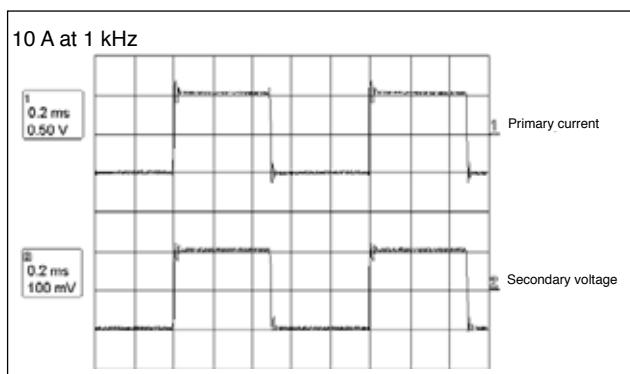
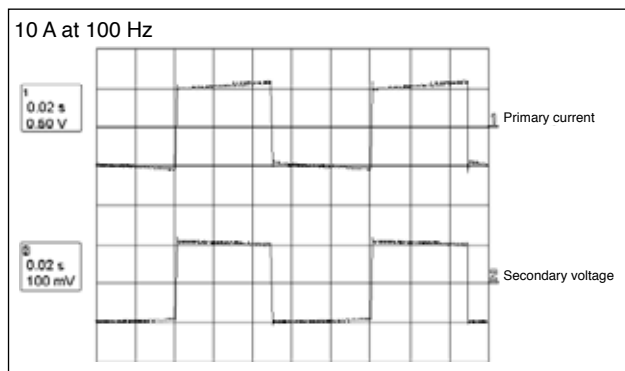
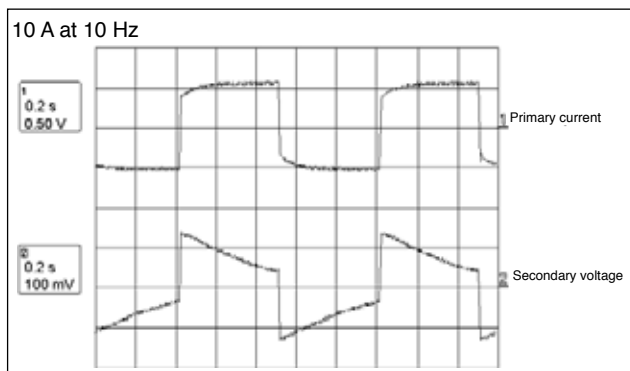

10 A calibre

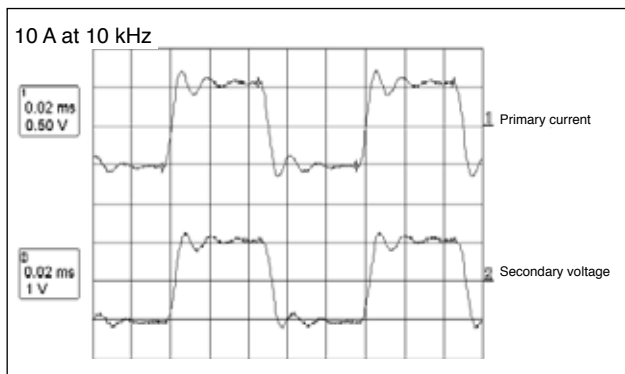
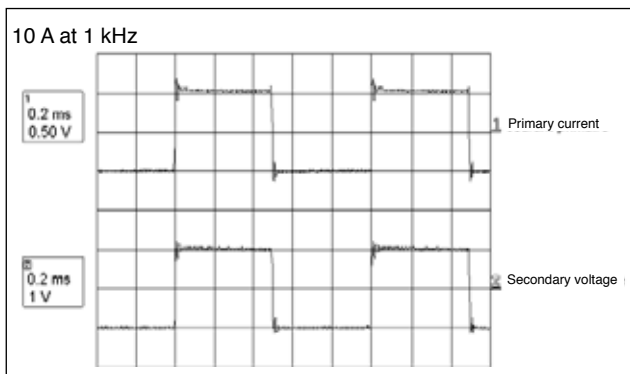
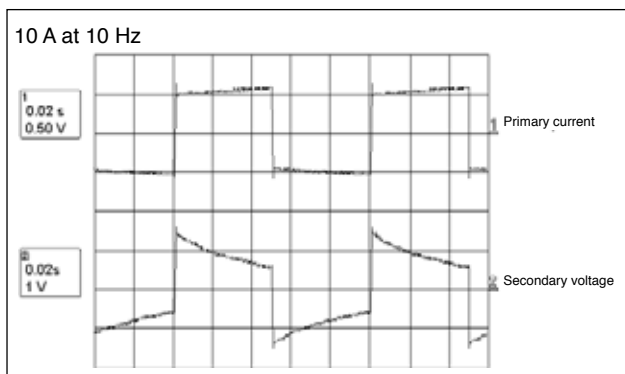
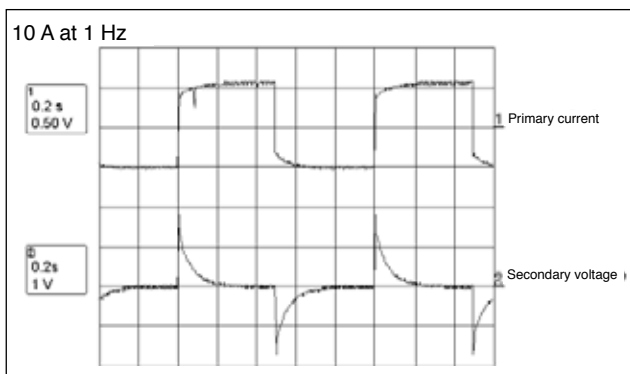

Current clamp for AC current

odel C⁴ probe for leakage currents

C100 series

Current	1 A	10 A	100 A	1000 A
Output	1 V/A	100 mV/A	10 mV/A	1 mV/A

Description

The C173 clamp measures leakage or differential currents from 1 mA upwards and can also be used with multimeters equipped with a range in mV AC.

The C173 clamp measures earth-loop currents and leakage currents. It also locates faults in circuits of single and three-phase networks.

For unearthed three-phase systems, use the optional Artificial Neutral.

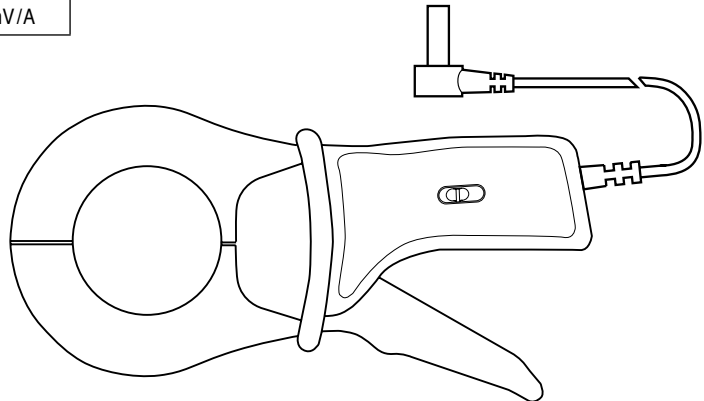

Electrical specifications

Current calibres:
 0.001 A AC...1.2 A AC
 0.01 A AC...12 A AC
 0.1 A AC...120 A AC
 1 A AC...1200 A AC

Output signal:
 1 VAC/A AC (1 V for 1 A)
 100 mVAC/A AC (1 V for 10 A)
 10 mVAC/A AC (1 V for 100 A)
 1 mVAC/A AC (1 V for 1000 A)

Accuracy and phase shift⁽¹⁾:

1 A calibre

Primary current	0.001 A...0.01 A	0.01 A...0.1 A	0.1 A...1 A	1 A...1.2 A
% Accuracy of output signal	≤ 3 % + 1 mV	≤ 3 % + 1 mV	≤ 0.7 % + 1 mV	≤ 0.7 % + 1 mV
Phase shift	not specified	not specified	≤ 10°	≤ 10°

10 A calibre

Primary current	0.01 A...0.1 A	0.1 A...1 A	1 A...10 A	10 A...12 A
Accuracy in % of output signal	≤ 1 % + 0.2 mV	≤ 0.5 % + 0.2 mV	≤ 0.5 %	≤ 0.5 %
Phase shift	not specified	≤ 5°	≤ 2°	≤ 2°

100 A calibre

Primary current	0.1 A...1 A	1 A...10 A	10 A...100 A	100 A...120 A
Accuracy in % of output signal	≤ 1 % + 0.2 mV	≤ 0.5 % + 0.2 mV	≤ 0.3 %	≤ 0.2 %
Phase shift	not specified	≤ 2°	≤ 1°	≤ 1°

1000 A calibre

Primary current	1 A...10 A	10 A...100 A	100 A...1000 A	1000 A...1200 A
% Accuracy of output signal	≤ 1 % + 0.2 mV	≤ 0.5 % + 0.2 mV	≤ 0.2 %	≤ 0.2 %
Phase shift	not specified	≤ 2°	≤ 1°	≤ 1°

Bandwidth:

10 Hz ... 3 kHz

Crest factor:

1 A calibre:

≤ 3 for I ≤ 3 A peak (1 Arms)

10 A calibre:

≤ 3 for I ≤ 30 A peak (10 Arms)

100 A calibre:

≤ 3 for I ≤ 300 A peak (100 Arms)

1000 A calibre:

≤ 3 for I ≤ 1700 A peak (500 Arms)

Maximum currents:

1000 A continuous for a frequency ≤ 500 Hz (limitation proportional to the inverse of 1/2 of frequency beyond)

Load impedance:

≥ 10 MΩ and ≤ 47 pF

Output impedance:

1 A calibre: 10 kΩ ± 10 %

10 A calibre: 1 kΩ ± 10 %

100 A calibre: 100 Ω ± 10 %

1000 A calibre: 100 Ω ± 10 %

Operating voltage:

600 Vrms

Common mode voltage:

600 V category III and pollution degree 2

Influence of adjacent conductor:

≤ 1 mA/A at 50 Hz

Influence of conductor position in jaws:

≤ 0.3 % of output signal for frequencies ≤ 400 Hz

Influence of frequency⁽²⁾:

1 A calibre:

< 2 % of output signal 30 Hz...48 Hz and 65 Hz...1 kHz

< 10 % of output signal 1 kHz...3 kHz

10 A calibre:

< 2 % of output signal 10 Hz...48 Hz and 65 Hz...3 kHz

100 A calibre:

< 1.5 % of output signal 10 Hz...48 Hz and 65 Hz...3 kHz

1000 A calibre:

< 1 % of output signal 10 Hz...48 Hz and 65 Hz...1 kHz

Influence of crest factor:

≤ 0.5 % for crest factor limited to 3

Influence of DC current superimposed on rated current:

≤ 10 % at 1000 A for a DC current of 10 A

Current clamp for AC current

odel C⁴ probe for leakage currents

C100 series

■ Mechanical specifications

Operating temperature:
-10 °C ... +50 °C

Storage temperature:
-40 °C ... +70 °C

Influence of temperature:
≤ 0.15 % of output signal per 10 °K from -10 °C ... +40 °C
≤ 0.2 % of output signal per 10 °K from +40 °C ... +50 °C

Relative humidity for operation:
0 ... 85 % RH with a linear decrease above 35 °C

Influence of relative humidity:
< 0.1 % of output signal from 10 % to 85 % RH

Operating altitude:
0 to 2,000 m

Max. jaw opening:
53 mm
Patented progressive opening system

Clamping capacity:
Cable: Ø max 52 mm
Busbar: 1 busbar of 50 x 5 mm or 4 busbars of 30 x 5 mm

Casing protection rating:
IP40 (IEC 529)

Drop test:
1 m (IEC 68-2-32)

Shock resistance:
100 g (IEC 68-2-27)

Vibration resistance:
5/15 Hz 1.5 mm
15/25 Hz 1 mm
25/55 Hz 0.25 mm
(IEC 68-2-6)

Self-extinguishing capability:
UL94 V0

Dimensions:
216 x 111 x 45 mm

Weight:
550 g

Colours:
Dark grey case with red jaws

Output:
1.5 m two-wire lead with double or reinforced insulation terminated by 2 elbowed male safety plugs (4 mm)

■ Safety specifications

Electrical safety:
Instrument with double insulation or reinforced insulation between the primary, the secondary and the grippable part located under the guard as per IEC 1010-1 & IEC 1010-2-032

- 600 V category III, pollution degree 2
- 300 V category IV, pollution degree 2

Electromagnetic compatibility (EMC):

EN 50081-1: class B

EN 50082-2:

- Electrostatic discharge: IEC 1000-4-2
- Radiated field: IEC 1000-4-3
- Fast transients: IEC 1000-4-4
- Magnetic field at 50/60 Hz: IEC 1000-4-8

(1) Conditions of reference: 23 °C ± 3 °K, 20 % to 75 % RH, sine signal, frequency of 48 Hz to 65 Hz, distortion factor < 1 %, no DC components, external magnetic field < 40 A/m, no AC magnetic field, conductor centred for measurement, load impedance: ≥ 10 MΩ and ≤ 47 pF

(2) Out of reference domain

To order	Reference
AC current clamp model C173 with operating manual	P01120309
Accessory: AN1 artificial neutral box (see chapter 12)	P01197201
Bag n°11	P01100120



D_N series

The D_N series comprises a range of high-performance clamp-on AC current probes designed for high current measurements.

Their excellent current transformation ratios and low phase shift, combined with a broad frequency response, allows highly accurate current and power measurements.

High-quality magnetic cores and windings mean high-precision current measurement up to 3000 A (AC).

The rectangular jaws can be used to clamp large-diameter cables or busbars.

The D_N series clamps provide true RMS measurement values and faithful signal reproduction.

There are two different kinds of model available in the D series: the first acts as a traditional current transformer with a current output (mA) and has a wide range of voltage ratios.

These clamps may also be used with multimeters, harmonic and power measurement equipment, logging apparatus or other instruments allowing AC current input.

The second type of model gives a voltage output in precise proportion to the measured current (1 mV/A, 10 mV/A or 100 mV/A) so you can display and log currents on instruments without current inputs.

Model D38N has been specifically designed for use with oscilloscopes, or other instruments with a BNC input.

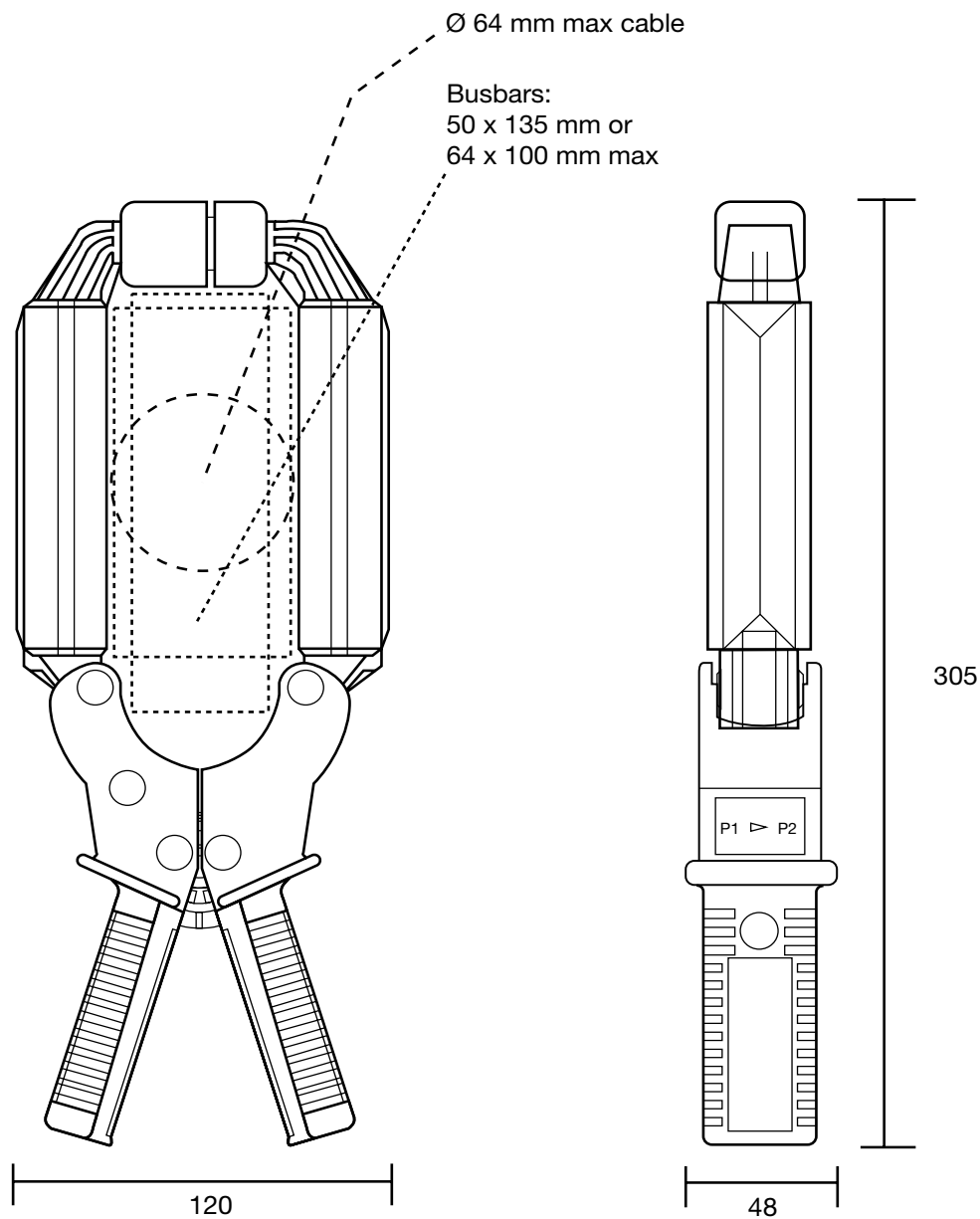

Current clamps for AC current models D30N and D30CN

DN series

Current	2400 A AC
Ratio	3000:1
Output	0.333 mA/A

Electrical specifications

Current calibre:
1 A AC ...2400 A AC
(3000 A for temperature < 35 °C)

Current transformation ratio:
3000:1

Output signal:
0.333 mA/A AC (1 A for 3000 A)

Accuracy and phase shift ⁽¹⁾:

Primary current	150 A	600 A	3000 A
% Accuracy of output signal	1.5 %	0.75 %	0.5 %
Phase shift	1.5°	0.75°	0.5°

Overload:
3600 A for 5 minutes

Maximum output voltage (secondary open):
Electronic protection limiting the voltage to 42 V peak max.

Accuracy:
In accordance with IEC 185-26-27, 5 VA, class 0.5 from 48 Hz to 1000 Hz

Bandwidth:
30 Hz to 5 kHz (in continuous use above 1 kHz, the max. measurement current is limited)

Ampere second product:
90 A.s

Load impedance:
< 5 Ω

Operating voltage:
600 V AC

Common mode voltage:
600 V AC

Influence of adjacent conductor:
0.005 A/A AC

Influence of conductor position in jaws:
1 % ± 0.1 A

Mechanical specifications

Operating temperature:
-10 °C to +50 °C

Storage temperature:
-25 °C to +80 °C

Influence of temperature:
< 0.1 % per 10°K

Max. jaw opening:
90 mm

Max. jaw insertion capacity:
Cable: 64 mm
Group of wires: 50 x 135 mm - 64 x 100 mm

Casing protection rating:
IP20 in accordance with IEC 529

Drop test:
500 mm (IEC 68-2-32)

Shock resistance:
100 g, in accordance with IEC 68-2-27

Vibration resistance:
10/55/10Hz, 0.15 mm test in accordance with IEC 68-2-6

Self-extinguishing capability:
Casing: UL94 V0
Jaws: UL94 V2

Dimensions:
120 x 315 x 48 mm

Weight:
1200 g

Colour:
Dark grey casing with red jaws

Output:
D30N: two safety sockets (4 mm)
D30CN: two-wire 1.5 m cable with reinforced insulation or double insulation ending with 2 elbowed 4 mm male safety plugs

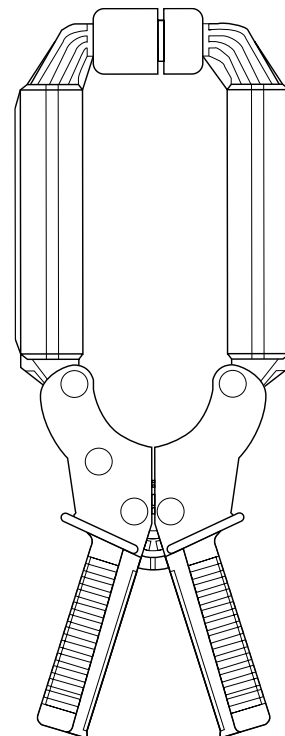

Safety specifications

Electrical safety:
Double insulation or reinforced insulation between the primary and the secondary circuits and the outside casing in accordance with IEC 1010-2-032.
- 600 V category III, pollution degree 2
- 300 V category IV, pollution degree 2

Electromagnetic compatibility (EMC):
EN 50081-1: class B
EN 50082-2:
- Electrical discharge IEC 1000-4-2
- Radial field IEC 1000-4-3
- Fast transients IEC 1000-4-4
- Magnetic field at 50/60 Hz IEC 1000-4-8

(1) Conditions of reference: 23 °C ± 5 °K, 20 % to 75 % RH, 48 Hz to 65 Hz, external magnetic field < 40 A/m, no DC component, no current-carrying conductor nearby, centred test sample, load impedance 5 Ω.

To order	Reference
AC current clamp model D30N with operating manual	P01120049A
AC current clamp model D30CN with operating manual	P01120064

Current clamp for AC current

odel d "n

DN series

Current	500 A AC	1000 A AC	1500 A AC
Ratio	500:1	1000:1	1500:1
Output	2 mA/A	1 mA/A	0.66 mA/A

Electrical specifications

Current calibres:

1 A AC ... 500 A AC
1 A AC ... 1000 A AC
1 A AC ... 1500 A AC

Current transformation ratio:

500:1, 1000:1, 1500:1

Output signal:

2 mA/A AC (1 A for 500 A)
1 mA/A AC (1 A for 1000 A)
0.66 mA/A AC (1 A for 1500 A)

Accuracy and phase shift ⁽¹⁾:

500 A calibre

Primary current	25 A	100 A	500 A
% Accuracy of output signal	4 %	3 %	3 %
Phase shift	4°	3.5°	2°

- Load impedance: 5 Ω
- Overload: 700 A for 10 minutes
- Ampere second product: 6 A.s
- Accuracy: in accordance with IEC 185-26-27, 5 VA, class 3 from 48 Hz to 1000 Hz

1000 A calibre

Primary current	50 A	200 A	1000 A
% Accuracy of output signal	3 %	1.5 %	1 %
Phase shift	3°	1.5°	1°

- Load impedance: 5 Ω
- Overload: 1400 A for 10 minutes
- Ampere second product: 30 A.s
- Accuracy: in accordance with IEC 185-26-27, 5 VA, class 1 from 48 Hz to 1000 Hz

1500 A calibre

Primary current	75 A	300 A	1500 A
% Accuracy of output signal	1.5 %	0.75 %	0.5 %
Phase shift	1.5°	0.75°	0.5°

- Load impedance: 5 Ω
- Overload: 1800 A for 10 minutes
- Ampere second product: 65 A.s
- Accuracy: in accordance with IEC 185-26-27, 5 VA, class 0.5 from 48 Hz to 1000 Hz

Bandwidth:

30 Hz to 1500 Hz (in continuous use above 1 kHz the max. measurement current is limited)

Load impedance:

< 5 Ω

Operating voltage:

600 V AC

Common mode voltage:

600 V AC

Max. voltage at output (secondary circuit open):

Electronic protection limiting the voltage to 42 V peak max.

Influence of adjacent conductor:

0.005 A/A AC

Influence of conductor position in jaws:

1.5 % ± 0.2 A on the 500:1 ratio
1 % ± 0.2 A on the 1000:1 ratio
1 % ± 0.2 A on the 1500:1 ratio

Mechanical specifications

Operating temperature:

-10 °C to +50 °C

Storage temperature:

-25 °C to +80 °C

Influence of temperature:

< 0.1 % per 10 °K

Max. jaw opening:

90 mm

Max. jaw insertion capacity:

Cable: 64 mm

Group of wires: 50 x 135 mm - 64 x 100 mm

Casing protection rating:

IP20 in accordance with IEC 529

Drop test:

500 mm (IEC 68-2-32)

Shock resistance:

100 g, in accordance with IEC 68-2-27

Vibration resistance:

10/55/10 Hz, 0.15 mm
test in accordance with IEC 68-2-6

Self-extinguishing capability:

Casing: UL94 V0

Jaws: UL94 V2

Dimensions:

120 x 315 x 48 mm

Weight:

1200 g

Colour:

Dark grey casing with red jaws

Output:

2 safety sockets (4 mm)

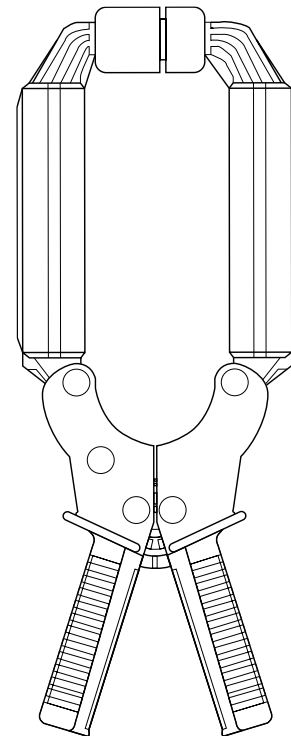

Safety specifications

Electrical safety:

Double insulation or reinforced insulation between the primary and the secondary circuits and the outside casing in accordance with IEC 1010-2-032.

- 600 V category III, pollution degree 2
- 300 V category IV, pollution degree 2

Electromagnetic compatibility (EMC):

EN 50081-1: class B

EN 50082-2:

- Electrical discharge IEC 1000-4-2
- Radial field IEC 1000-4-3
- Fast transients IEC 1000-4-4
- Magnetic field at 50/60 Hz IEC 1000-4-8

(1) Conditions of reference: 23 °C ± 5 °K, 20 % to 75 % RH, 48 Hz to 65 Hz, external magnetic field < 40 A/m, no DC component, no current-carrying conductor nearby, centred test sample.

To order	Reference
AC current clamp model D31N with operating manual	P01120050A

Current clamp for AC current

Model D32N

DN series

Current	1000 A AC	2000 A AC	2400 A AC
Ratio	1000:1	2000:1	3000:1
Output	1 mA/A	0.5 mA/A	0.333 mA/A

Electrical specifications

Current calibres:

1 A AC ... 1000 A AC
1 A AC ... 2000 A AC
1 A AC ... 2400 A AC

Current transformation ratio:

1000:1, 2000:1, 3000:1

Output signal:

1 mA/A AC (1 A for 1000 A)
0.5 mA/A AC (1 A for 2000 A)
0.333 mA/A AC (1 A for 3000 A)

Accuracy and phase shift ⁽¹⁾:

1000 A calibre

Primary current	50 A	200 A	1000 A
% Accuracy of output signal	3 %	1.5 %	1 %
Phase shift	3°	1.5°	1°

- Load impedance: 2.5 Ω
- Overload: 1400 A for 10 minutes
- Ampere second product: 25 A.s
- Accuracy: in accordance with IEC 185-26-27, 2.5 VA, class 1 from 48 Hz to 1000 Hz

2000 A calibre

Primary current	100 A	400 A	2000 A
% Accuracy of output signal	1.5 %	0.75 %	0.5 %
Phase shift	1.5°	0.75°	0.5°

- Load impedance: 5 Ω
- Overload: 2400 A for 10 minutes
- Ampere second product: 60 A.s
- Accuracy: in accordance with IEC 185-26-27, 5 VA, class 0.5 from 48 Hz to 1000 Hz

3000 A calibre

Primary current	150 A	600 A	3000 A
% Accuracy of output signal	1.5 %	0.75 %	0.5 %
Phase shift	1.5°	0.75°	0.5°

- Load impedance: 10 Ω
- Overload: 3400 A for 10 minutes
- Ampere second product: 90 A.s
- Accuracy: in accordance with IEC 185-26-27, 10 VA, class 0.5 from 48 Hz to 1000 Hz

Bandwidth:

30 Hz to 1000 Hz (in continuous use above 600 Hz the max. measurement current is limited)

Load impedance:

< 10 Ω max

Operating voltage:

600 V AC

Common mode voltage:

600 V AC

Max. voltage at output (secondary circuit open):

Electronic protection limiting the voltage to 42 V peak max.

Influence of adjacent conductor:

0.005 A/A AC

Influence of conductor position in jaws:

1.5 % ± 0.2 A on the 1000:1 ratio
1 % ± 0.2 A on the 2000:1 ratio
1 % ± 0.2 A on the 3000:1 ratio

Mechanical specifications

Operating temperature:

-10 °C to +50 °C

Storage temperature:

-25 °C to +80 °C

Influence of temperature:

< 0.1 % per 10 °K

Max. jaw opening:

90 mm

Max. jaw insertion capacity:

Cable: 64 mm
Group of wires: 50 x 135 mm - 64 x 100 mm

Casing protection rating:

IP20 in accordance with IEC 529

Drop test:

500 mm (IEC 68-2-32)

Shock resistance:

100 g, in accordance with IEC 68-2-27

Vibration resistance:

10/55/10 Hz, 0.15 mm
test in accordance with IEC 68-2-6

Self-extinguishing capability:

Casing: UL94 V0
Jaws: UL94 V2

Dimensions:

120 x 315 x 48 mm

Weight:

1200 g

Colour:

Dark grey casing with red jaws

Output:

2 safety sockets (4 mm)

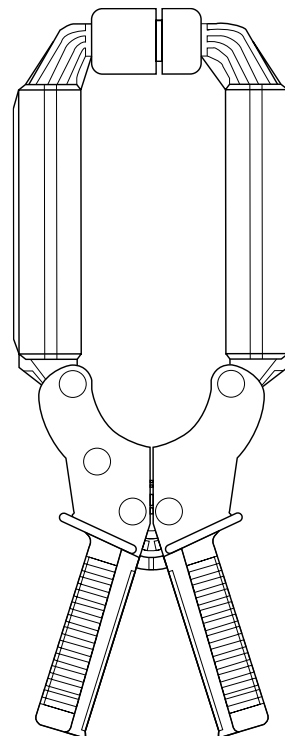

Safety specifications

Electrical safety:

Double insulation or reinforced insulation between the primary and the secondary circuits and the outside casing in accordance with IEC 1010-2-032.
- 600 V category III, pollution degree 2
- 300 V category IV, pollution degree 2

Electromagnetic compatibility (EMC):

EN 50081-1: class B
EN 50082-2:
- Electrical discharge IEC 1000-4-2
- Radial field IEC 1000-4-3
- Fast transients IEC 1000-4-4
- Magnetic field at 50/60 Hz IEC 1000-4-8

(1) Conditions of reference: 23 °C ± 5 °K, 20 % to 75 % RH, 48 Hz to 65 Hz, external magnetic field < 40 A/m, no DC component, no current-carrying conductor nearby, centred test sample.

To order	Reference
AC current clamp model D32N with operating manual	P01120051A

Current clamp for AC current

odel d n

DN series

Current	2400 A AC
Ratio	3000:5
Output	1.666 mA/A

■ Electrical specifications

Current calibre:

1 A AC ...2400 A AC
(3000 A for temperature < 35 °C)

Current transformation ratio:
3000:5

Output signal:

1.666 mA/A AC (5 A for 3000 A)

Accuracy and phase shift ⁽¹⁾:

Primary current	150 A	600 A	3000 A
Accuracy in % of output signal	3 %	1.5 %	1 %
Phase shift	3°	1.5°	1°

Overload:

3600 A for 10 minutes

Accuracy:

In accordance with IEC 185-26-27, 5 VA class 1 from 48 Hz to 1000 Hz

Bandwidth:

30 Hz to 5 kHz (in continuous use above 1 kHz, the max. measurement current is limited)

Ampere second product:

90 A.s

Load impedance:

< 1 Ω

Operating voltage:

600 V AC

Common mode voltage:

600 V AC

Influence of adjacent conductor:

0.005 A/A AC

Influence of conductor position in jaws:

1 % ± 0.1 A

■ Mechanical specifications

Operating temperature:

-10 °C to +50 °C

Storage temperature:

-25 °C to +80 °C

Influence of temperature:

< 0.1 % per 10 °K

Max. jaw opening:

90 mm

Max. jaw insertion capacity:

Cable: 64 mm

Group of wires: 50 x 135 mm - 64 x 100 mm

Casing protection rating:

IP20 in accordance with IEC 529

Drop test:

500 mm (IEC 68-2-32)

Shock resistance:

100 g, in accordance with IEC 68-2-27

Vibration resistance:

10/55/10 Hz, 0.15 mm test in accordance with IEC 68-2-6

Self-extinguishing capability:

Casing: UL94 V0

Jaws: UL94 V2

Dimensions:

120 x 315 x 48 mm

Weight:

1200 g

Colour:

Dark grey casing with red jaws

Output:

2 safety sockets (4 mm)

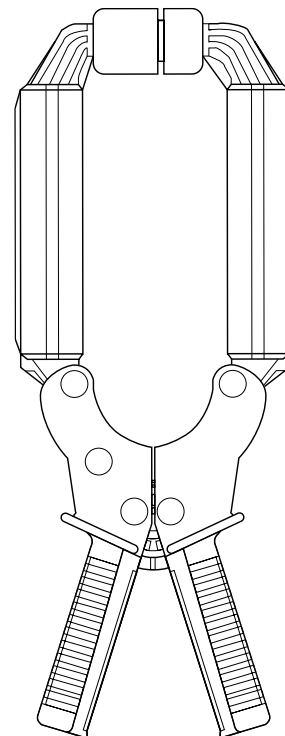

■ Safety specifications

Electrical safety:

Double insulation or reinforced insulation between the primary and the secondary circuits and the outside casing in accordance with IEC 1010-2-032.

- 600 V category III, pollution degree 2
- 300 V category IV, pollution degree 2

Electromagnetic compatibility (EMC):

EN 50081-1: class B

EN 50082-2:

- Electrical discharge IEC 1000-4-2
- Radial field IEC 1000-4-3
- Fast transients IEC 1000-4-4
- Magnetic field at 50/60 Hz IEC 1000-4-8

(1) Conditions of reference: 23 °C ± 5 °K, 20 % to 75 % RH, 48 Hz to 65 Hz, external magnetic field < 40 A/m, no DC component, no current-carrying conductor nearby, centred test sample, load impedance 0.2 Ω.

To order	Reference
AC current clamp model D33N with operating manual	P01120052A

Current clamp for AC current

Model D34N

DN series

Current	500 A AC	1000 A AC	1500 A AC
Ratio	500:5	1000:5	1500:5
Output	10 mA/A	5 mA/A	3.33 mA/A

Electrical specifications

Current calibres:

1 A AC ... 500 A AC
1 A AC ... 1000 A AC
1 A AC ... 1500 A AC

Current transformation ratio:

500:5, 1000:5, 1500:5

Output signal:

10 mA/A AC (5 A for 500 A)
5 mA/A AC (5 A for 1000 A)
3.33 mA/A AC (5 A for 1500 A)

Accuracy and phase shift⁽¹⁾:

500 A calibre

Primary current	25 A	100 A	500 A
Accuracy in % of output signal	5 %	3 %	3 %
Phase shift	6°	4°	4°

- Load impedance: 0.2 Ω
- Overload: 700 A for 10 minutes
- Ampere second product: 3.5 A.s
- Accuracy: in accordance with IEC 185-26-27, 5 VA class 3 from 48 Hz to 1000 Hz

1000 A calibre

Primary current	50 A	200 A	1000 A
Accuracy in % of output signal	3 %	1.5 %	1 %
Phase shift	3°	1.5°	1°

- Load impedance: 0.1 Ω
- Overload: 1400 A for 10 minutes
- Ampere second product: 18 A.s
- Accuracy: in accordance with IEC 185-26-27, 2.5 VA class 1 from 48 Hz to 1000 Hz

1500 A calibre

Primary current	75 A	300 A	1500 A
Accuracy in % of output signal	1.5 %	0.75 %	0.5 %
Phase shift	1.5°	0.75°	0.5°

- Load impedance: 0.1 Ω
- Overload: 1800 A for 10 minutes
- Ampere second product: 40 A.s
- Accuracy: in accordance with IEC 185-26-27, 2.5 VA class 0.5 from 48 Hz to 1000 Hz

Bandwidth:

30 Hz to 1500 Hz (in continuous use above 1.5 kHz the max. measurement current is limited)

Load impedance:

< 1 Ω max

Operating voltage:

600 V AC

Common mode voltage:

600 V AC

Max. voltage at output (secondary circuit open):

Electronic protection limiting the voltage to 42 V peak max.

Influence of adjacent conductor:

0.005 A/A AC

Influence of conductor position in jaws:

1.5 % ± 0.2 A on the 500:5 ratio
1 % ± 0.2 A on the 1000:5 ratio
1 % ± 0.2 A on the 1500:5 ratio

Mechanical specifications

Operating temperature:

-10 °C to +50 °C

Storage temperature:

-25 °C to +80 °C

Influence of temperature:

< 0.1 % per 10 °K

Max. jaw opening:

90 mm

Max. jaw insertion capacity:

Cable: 64 mm
Group of wires: 50 x 135 mm - 64 x 100 mm

Casing protection rating:

IP20 in accordance with IEC 529

Drop test:

500 mm (IEC 68-2-32)

Shock resistance:

100 g, in accordance with IEC 68-2-27

Vibration resistance:

10/55/10 Hz, 0.15 mm
test in accordance with IEC 68-2-6

Self-extinguishing capability:

Casing: UL94 V0
Jaws: UL94 V2

Dimensions:

120 x 315 x 48 mm

Weight:

1200 g

Colour:

Dark grey casing with red jaws

Output:

2 safety sockets (4 mm)

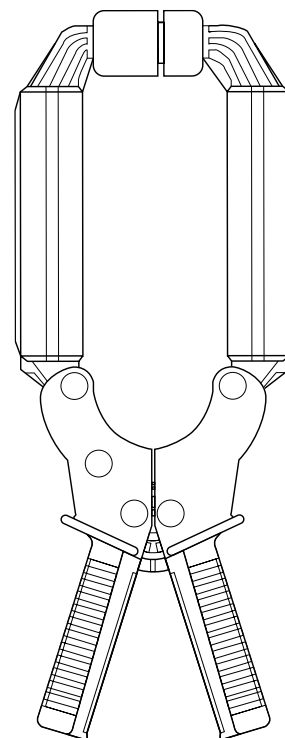

Safety specifications

Electrical safety:

Double insulation or reinforced insulation between the primary and the secondary circuits and the outside casing in accordance with IEC 1010-2-032.

- 600 V category III, pollution degree 2
- 300 V category IV, pollution degree 2

Electromagnetic compatibility (EMC):

EN 50081-1: class B

EN 50082-2:

- Electrical discharge IEC 1000-4-2
- Radial field IEC 1000-4-3
- Fast transients IEC 1000-4-4
- Magnetic field at 50/60 Hz IEC 1000-4-8

(1) Conditions of reference: 23 °C ± 5 °K, 20 % to 75 % RH, 48 Hz to 65 Hz, external magnetic field < 40 A/m, no DC component, no current-carrying conductor nearby, centred test sample.

To order	Reference
AC current clamp model D34N with operating manual	P01120053A

Current clamp for AC current

odel d n

DN series

Current	1000 A AC	2000 A AC	2400 A AC
Ratio	1000:5	2000:5	3000:5
Output	5 mA/A	2.5 mA/A	1.666 mA/A

Electrical specifications

Current calibres:

- 1 A AC ... 1000 A AC
- 1 A AC ... 2000 A AC
- 1 A AC ... 2400 A AC (3000 A for temperature < 35 °C)

Current transformation ratio:

1000:5, 2000:5, 3000:5

Output signal:

- 5 mA/A AC (5 A for 1000 A)
- 2.5 mA/A AC (5 A for 2000 A)
- 1.666 mA/A AC (5 A for 3000 A)

Accuracy and phase shift ⁽¹⁾:

1000 A calibre

Primary current	50 A	200 A	1000 A
% Accuracy of output signal	3 %	1.5 %	1 %
Phase shift	3°	1.5°	1°

- Load impedance: 0.1 Ω
- Overload: 1200 A for 10 minutes
- Ampere second product: 15 A.s
- Accuracy: in accordance with IEC 185-26-27, 2.5 VA, class 1 from 48 Hz to 1000 Hz

2000 A calibre

Primary current	100 A	400 A	2000 A
% Accuracy of output signal	1.5 %	0.75 %	0.5 %
Phase shift	1.5°	0.75°	0.5°

- Load impedance: 0.2 Ω
- Overload: 2400 A for 10 minutes
- Ampere second product: 50 A.s
- Accuracy: in accordance with IEC 185-26-27, 5 VA, class 0.5 from 48 Hz to 1000 Hz

3000 A calibre

Primary current	150 A	600 A	3000 A
% Accuracy of output signal	1.5 %	0.75 %	0.5 %
Phase shift	1.5°	0.75°	0.5°

- Load impedance: 0.4 Ω
- Overload: 2400 A for 10 minutes
- Ampere second product: 80 A.s
- Accuracy: in accordance with IEC 185-26-27, 10 VA class 0.5 from 48 Hz to 1000 Hz

Bandwidth:

30 Hz to 1500 Hz (in continuous use above 1.5 kHz, the max. measurement current is limited)

Load impedance:

< 2 Ω max

Operating voltage:

600 V AC

Common mode voltage:

600 V AC

Influence of adjacent conductor:

0.005 A/A AC

Influence of conductor position in jaws:

- 1.5 % ± 0.2 A on the 1000:5 ratio
- 1 % ± 0.2 A on the 2000:5 ratio
- 1 % ± 0.2 A on the 3000:5 ratio

Mechanical specifications

Operating temperature:

-10 °C to +50 °C

Storage temperature:

-25 °C to +80 °C

Influence of temperature:

< 0.1 % per 10 °K

Max. jaw opening:

90 mm

Max. jaw insertion capacity:

- Cable: 64 mm
- Group of wires: 50 x 135 mm - 64 x 100 mm

Casing protection rating:

IP20 in accordance with IEC 529

Drop test:

500 mm (IEC 68-2-32)

Shock resistance:

100 g, in accordance with IEC 68-2-27

Vibration resistance:

10/55/10 Hz, 0.15 mm test in accordance with IEC 68-2-6

Self-extinguishing capability:

Casing: UL94 V0

Jaws: UL94 V2

Dimensions:

120 x 315 x 48 mm

Weight:

1200 g

Colour:

Dark grey casing with red jaws

Output:

Safety sockets (4 mm)

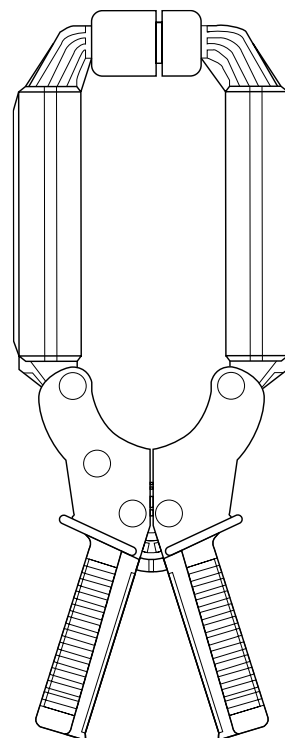

Safety specifications

Electrical safety:

Double insulation or reinforced insulation between the primary and the secondary circuits and the outside casing in accordance with IEC 1010-2-032.

- 600 V category III, pollution degree 2
- 300 V category IV, pollution degree 2

Electromagnetic compatibility (EMC):

EN 50081-1: class B

EN 50082-2:

- Electrical discharge IEC 1000-4-2
- Radial field IEC 1000-4-3
- Fast transients IEC 1000-4-4
- Magnetic field at 50/60 Hz IEC 1000-4-8

(1) Conditions of reference: 23 °C ± 5 °K, 20 % to 75 % RH, 48 Hz to 65 Hz, external magnetic field < 40 A/m, no DC component, no current-carrying conductor nearby, centred test sample.

To order	Reference
AC current clamp model D35N with operating manual	P01120054A

Current clamp for AC current

odel d n

DN series

Current	3000 A AC
Ratio	3000:3
Output	1 mA/A

■ Electrical specifications

Current calibre:

1 A AC ... 2400 A AC

Current transformation ratio:

3000:3

Output signal:

1 mA/A AC (3 A for 3000 A)

Accuracy and phase shift ⁽¹⁾:

Primary current	150 A	600 A	3000 A
% Accuracy of output signal	0.5 %	0.75 %	0.5 %
Phase shift	1.5°	0.75°	0.5°

Accuracy:

In accordance with IEC 185-26-27, 5 VA, class 0.5 from 48 Hz to 1000 Hz

Bandwidth:

30 Hz to 5 kHz

(beyond 400 Hz the output is limited in inverse proportion to the frequency)

Overload:

3600 A for 5 minutes

Max. voltage output

(secondary circuit open):

Electronic protection limiting the voltage to 42 V peak max.

Load impedance:

< 0.6 Ω

Operating voltage:

600 V AC

Common mode voltage:

600 V AC

Influence of adjacent conductor:

0.005 A/A AC

Influence of conductor position in jaws:

1 % ± 0.1 A

■ Mechanical specifications

Operating temperature:

-10 °C to +50 °C

Storage temperature:

-25 °C to +80 °C

Influence of temperature:

< 0.1 % per 10 °K

Max. jaw opening:

90 mm

Max. jaw insertion capacity:

Cable: 64 mm

Group of wires: 50 x 135 mm - 64 x 100 mm

Casing protection rating:

IP20 in accordance with IEC 529

Drop test:

500 mm (IEC 68-2-32)

Shock resistance:

100 g, in accordance with IEC 68-2-27

Vibration resistance:

10/55/10 Hz, 0.15 mm

test in accordance with IEC 68-2-6

Self-extinguishing capability:

Casing: UL94 V0

Jaws: UL94 V2

Dimensions:

120 x 315 x 48 mm

Weight:

1200 g

Colour:

Dark grey casing with red jaws

Output:

Safety sockets (4 mm)

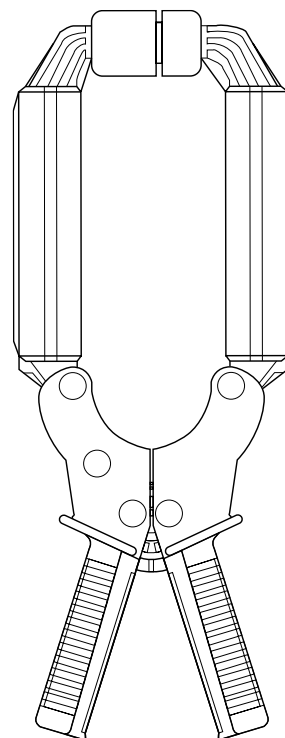

■ Safety specifications

Electrical safety:

Double insulation or reinforced insulation between the primary and the secondary circuits and the outside casing in accordance with IEC 1010-2-032.

- 600 V category III, pollution degree 2
- 300 V category IV, pollution degree 2

Electromagnetic compatibility (EMC):

EN 50081-1: class B

EN 50082-2:

- Electrical discharge IEC 1000-4-2
- Radial field IEC 1000-4-3
- Fast transients IEC 1000-4-4
- Magnetic field at 50/60 Hz IEC 1000-4-8

(1) Conditions of reference: 23 °C ± 5 °K, 20 % to 75 % RH, 48 Hz to 65 Hz, external magnetic field < 40 A/m, no DC component, no current-carrying conductor nearby, centred test sample, load impedance 0,55 Ω.

To order	Reference
AC current clamp model D36N with operating manual	P01120055A

Current clamp for AC current

odel d n

DN series

Current	30 A AC	300 A AC	3000 A AC
Output	100 mV/A	10 mV/A	1 mV/A

Electrical specifications

Current calibres:

10 mA...30 A AC
1 A AC...300 A AC
1 A AC...2000 A AC
(2800 A for temperature < 35 °C)

Output signal:

100 mV/A AC (3 V for 30 A) 90 A peak
10 mV/A AC (3 V for 300 A) 900 A peak
1.666 mV/A AC (3 V for 3000 A) 9000 A peak

Accuracy and phase shift⁽¹⁾:

30 A calibre

Primary current	1.5 A	6 A	30 A
% Accuracy of output signal	2 % ± 10 mV		
Phase shift	15°	7°	5°

300 A calibre

Primary current	15 A	60 A	300 A
% Accuracy of output signal	2 % ± 2 mV		
Phase shift	3°	1.5°	1°

3000 A calibre

Primary current	150 A	600 A	3000 A
% Accuracy of output signal	2 % ± 0.5 mV		
Phase shift	1.5°	1°	0.5°

Overload:

3200 A for 5 mn

Ampere second product:

100 A.s

dV/dt:

100 mVAC/A AC: dV/dt = 400 mV/μs
10 mVAC/A AC: dV/dt = 50 mV/μs
1 mVAC/A AC: dV/dt = 5 mV/μs

Bandwidth:

30 Hz to 5 kHz (on the 3000 A range the max. measurement current is limited above 200 Hz)

Load impedance:

≥ 1 MΩ

Operating voltage:

600 V AC

Common mode voltage:

600 V AC

Influence of adjacent conductor:

0.005 A/A AC

Influence of conductor position in jaws:

1.5 % of the reading

Influence of frequency:

30 Hz to 5 kHz:
± 6 % on all calibres

Influence of DC current:

0.04 % per A DC

Mechanical specifications

Operating temperature:

-10 °C to +50 °C

Storage temperature:

-25 °C to +80 °C

Influence of temperature:

< 0.1 % per 10 °K

Max. jaw opening:

90 mm

Max. jaw insertion capacity:

Cable: 64 mm
Group of wires: 50 x 135 mm - 64 x 100 mm

Casing protection rating:

IP20 in accordance with IEC 529

Drop test:

500 mm (IEC 68-2-32)

Shock resistance:

100 g, in accordance with IEC 68-2-27

Vibration resistance:

10/55/10 Hz, 0.15 mm
test in accordance with IEC 68-2-6

Self-extinguishing capability:

Casing: UL94 V0
Jaws: UL94 V2

Dimensions:

120 x 315 x 48 mm

Weight:

1200 g

Colour:

Dark grey casing with red jaws

Output:

Safety sockets (4 mm)

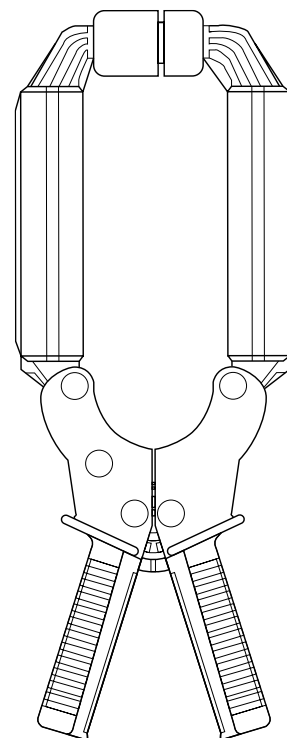

Safety specifications

Electrical safety:

Double insulation or reinforced insulation between the primary and the secondary circuits and the outside casing in accordance with IEC 1010-2-032.
- 600 V category III, pollution degree 2
- 300 V category IV, pollution degree 2

Electromagnetic compatibility (EMC):

EN 50081-1: class B
EN 50082-2:
- Electrical discharge IEC 1000-4-2
- Radial field IEC 1000-4-3
- Fast transients IEC 1000-4-4
- Magnetic field at 50/60 Hz IEC 1000-4-8

(1) Conditions of reference: 23 °C ± 5 °K, 20 % to 75 % RH, 48 Hz to 65 Hz, external magnetic field < 40 A/m, no DC component, no current-carrying conductor nearby, centred test sample.

To order	Reference
AC current clamp model D37N with operating manual	P01120056A

oscilloscope clamp for AC current

odel d n insulated AC current probe

D_N series

Current	90 A peak	900 A peak	9000 A peak
Output	10 mV/A	1 mV/A	0.1 mV/A

Description

The D38N offers accurate AC current measurement and a voltage output in mV allowing direct readings on oscilloscopes. A switch with 3 positions on the handle can be used to select the ranges. The wide opening of the jaws means they can be used on cables and small busbars.

Electrical specifications

Current calibres:

1 A AC ... 30 A AC (90 A peak)
 1 A AC ... 300 A AC (900 A peak)
 1 A AC ... 2400 A AC (9000 A peak)
 (3000 A for temperature < 35 °C)

Output signal:

10 mV/A AC (3 V for 30 A)
 1 mV/A AC (3 V for 300 A)
 0.1 mV/A AC (3 V for 3000 A)

Accuracy and phase shift ⁽¹⁾:

30 A calibre

Primary current	1.5 A	6 A	30 A	36 A
% Accuracy of output signal	2 % ± 1 mV			
Phase shift	≤ 20°	≤ 10°	≤ 5°	≤ 5°

300 A calibre

Primary current	15 A	60 A	300 A	360 A
% Accuracy of output signal	2 % ± 0.5 mV			
Phase shift	≤ 3°	≤ 1.5°	≤ 1°	≤ 1°

3000 A calibre

Primary current	150 A	600 A	3000 A	3600 A
% Accuracy of output signal	2 % ± 0.2 mV			
Phase shift	≤ 3°	≤ 1.5°	≤ 1°	≤ 1°

Bandwidth:

10 Hz to 50 kHz (depending on current)

Rise/fall time from 10 % to 90 %:

4 μs

10 % delay time:

0.3 μs

Ampere second product:

30 A calibre: 30 A.s
 300 A calibre: 125 A.s
 3000 A calibre: 180 A.s

Insertion impedance (at 400 Hz / 10 kHz):

30 A calibre: < 0.1 mΩ / < 1 mΩ
 300 A calibre: < 0.1 mΩ / < 0.5 mΩ
 3000 A calibre: < 0.1 mΩ / < 0.4 mΩ

Maximum currents:

I < 2400 A permanent
 2400 A ... 2800 A for 10 minutes and then 30 minutes shutdown
 2800 A ... 4000 A for 5 minutes and then 30 minutes shutdown

Output impedance:

30 A calibre: ≤ 130 Ω ± 15 %
 300 A calibre: ≤ 140 Ω ± 15 %
 3000 A calibre: ≤ 140 Ω ± 15 %

Influence of temperature:

≤ 0.2 % of output signal per 10 °K

Influence of adjacent conductor:

≤ 5 mA/A at 50 Hz

Influence of DC current < 10 % of rated calibre superimposed on the rated current:

0.05 % / A DC

Influence of conductor position in jaws:

≤ 1 % + 0.1 A at 50/60 Hz

Influence of frequency ⁽²⁾:

30 A calibre: < 1 dB from 10 Hz...10 kHz
 300 A calibre: < 1 dB from 10 Hz...10 kHz
 3000 A calibre: < 1 dB from 10 Hz...10 kHz

Mechanical specifications

Max. jaw opening:

90 mm

Clamping capacity:

Cable: Ø max 64 mm
 Group of busbars:
 5 busbars of 125 x 5 mm
 3 busbars of 100 x 10 mm
 (busbars spaced by their thickness)

Output:

2 m coaxial lead with insulated BNC plug

Dimensions:

310 x 120 x 48 mm

Weight:

1200 g

Operating temperature:

-10 °C to +50 °C

Storage temperature:

-25 °C to +80 °C

Relative humidity for operation:

0 to 85 % RH with a linear decrease above 35 °C

Operating altitude:

0 to 2,000 m

Casing protection rating:

IP 20 (IEC 529)

Drop test:

0.5 m (IEC 68-2-32)

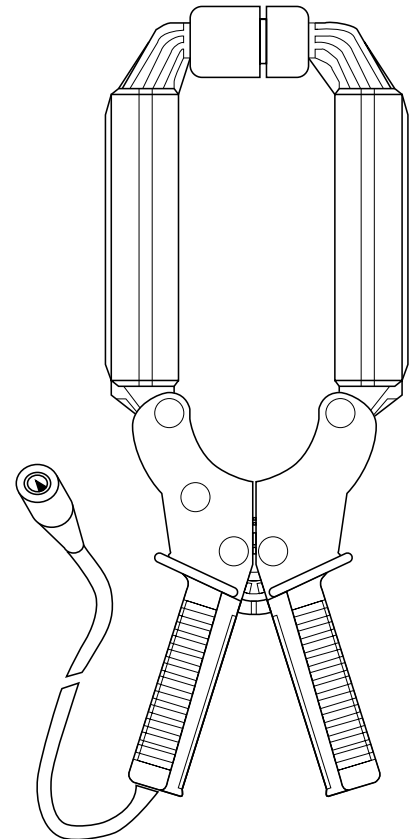

Shock resistance:

100 g / 6 ms / half-period (IEC 68-2-27)

Protection against impacts:

IK04 0.5 J (EN 50102)

Vibration resistance:

10/55/10 Hz, 0.15 mm (IEC 68-2-6)

Self-extinguishing capability:

Handles: UL94 V0

Jaws: UL94 V2

Colours:

Dark grey handles with red jaws

Safety specifications

Electrical safety:

Instrument with double insulation or reinforced insulation between the primary, the secondary and the grippable part located under the guard as per IEC 1010-1 & IEC 1010-2-032

- 600 V category III, pollution degree 2

- 300 V category IV, pollution degree 2

oscilloscope clamp for AC current

model d n insulated AC current probe

D_N series

■ Curves at 50 Hz

30 A calibre

Error on measurement

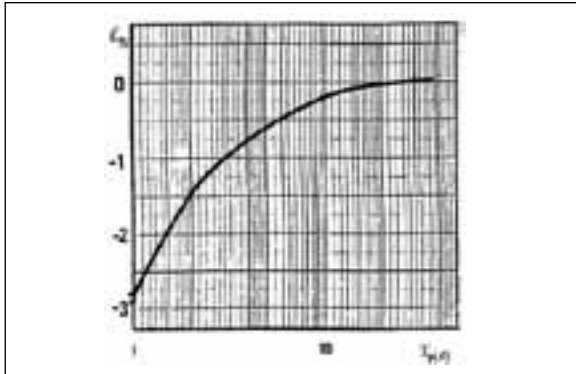

Phase shift

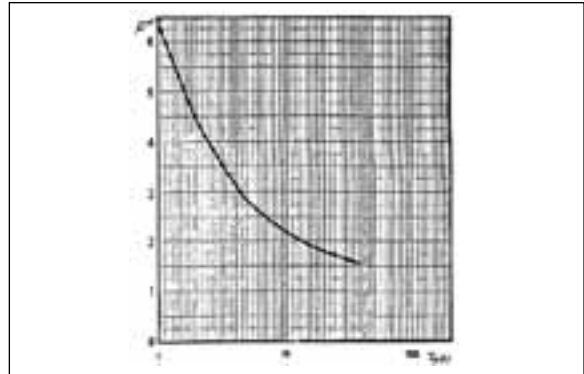

300 A calibre

Error on measurement

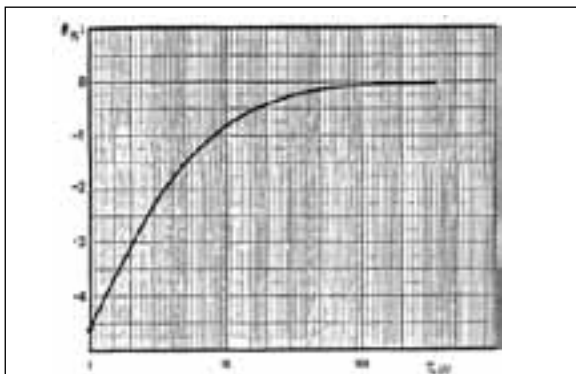

Phase shift

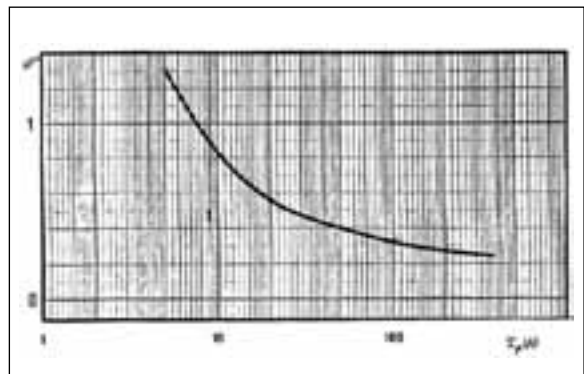

3000 A calibre

Error on measurement

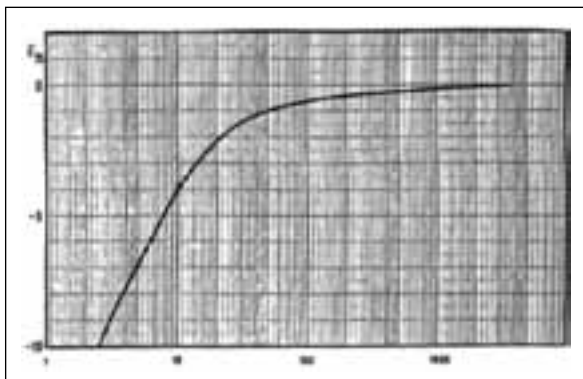

Phase shift

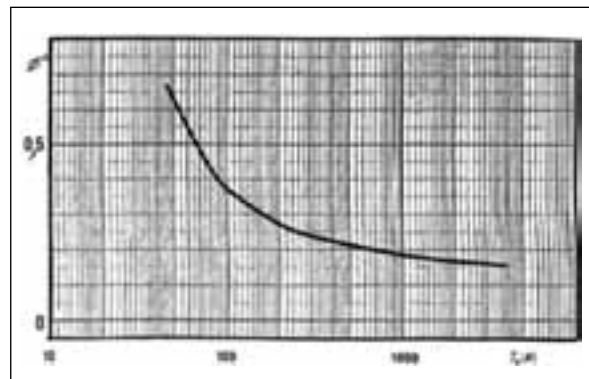

oscilloscope clamp for AC current

model n insulated AC current probe

D_N series

■ Frequency response

30 A calibre

I = 10 A

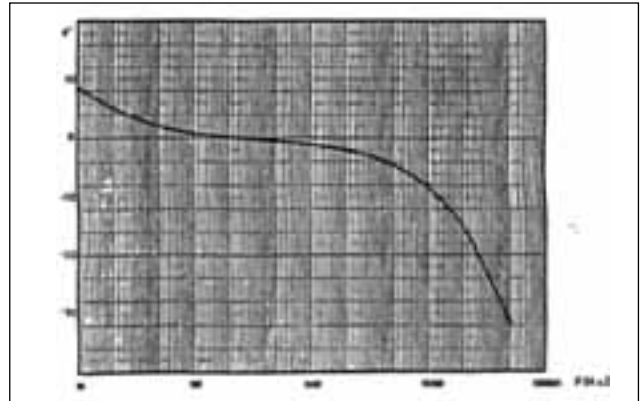
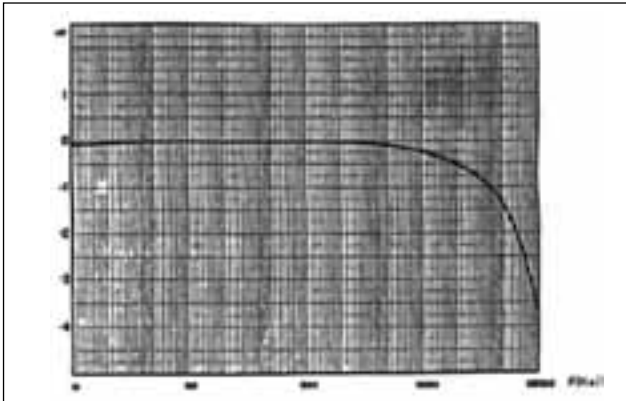

300 A calibre

I = 10 A

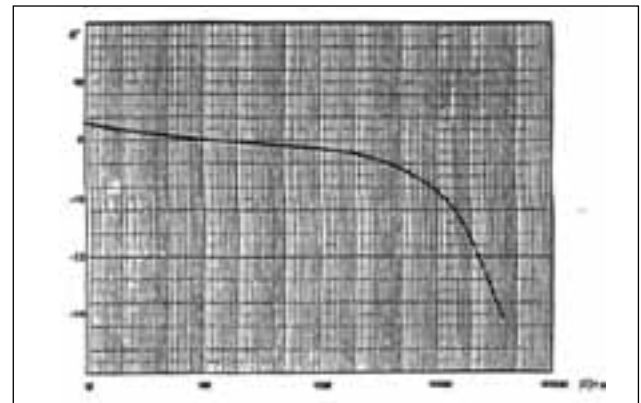
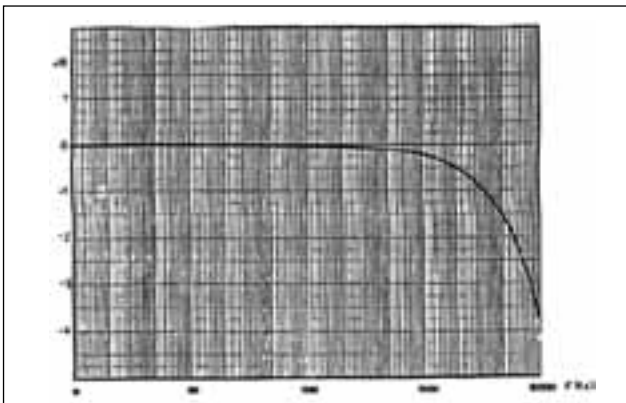

3000 A calibre

I = 100 A

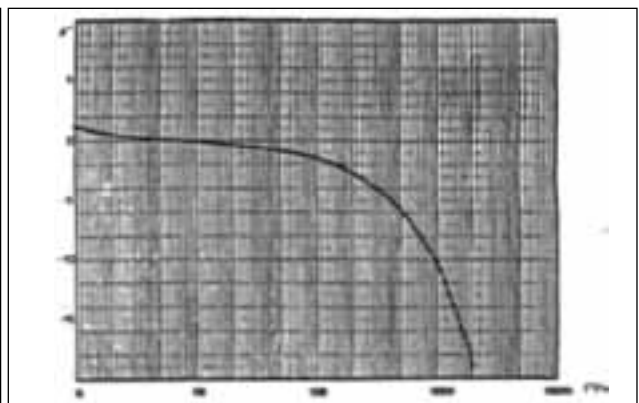
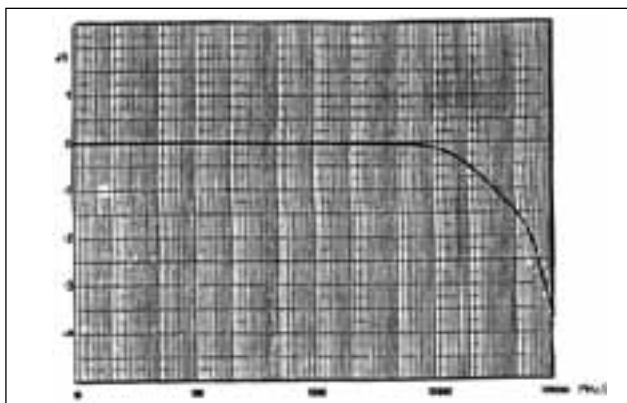

oscilloscope clamp for AC current model n insulated AC current probe

■ Response to a step ($I_p = 1$ A)

30 A calibre

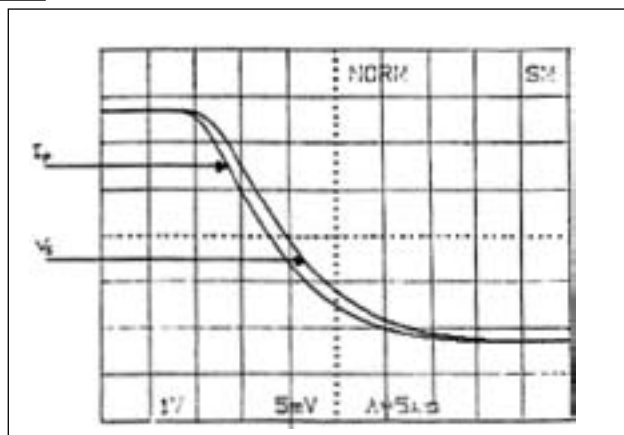
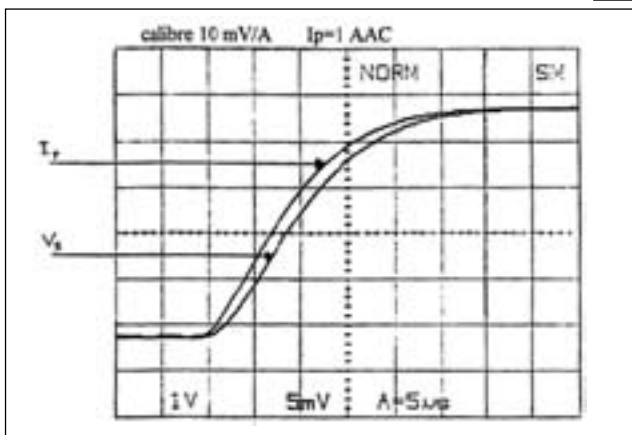

■ Response to a square signal ($I_p = 10$ A)

30 A calibre

10 Hz

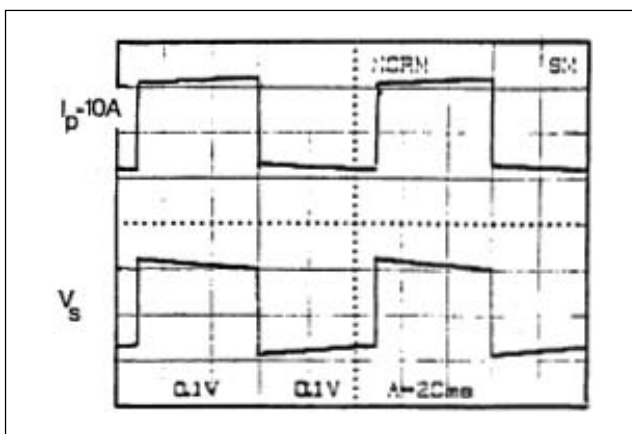

100 Hz

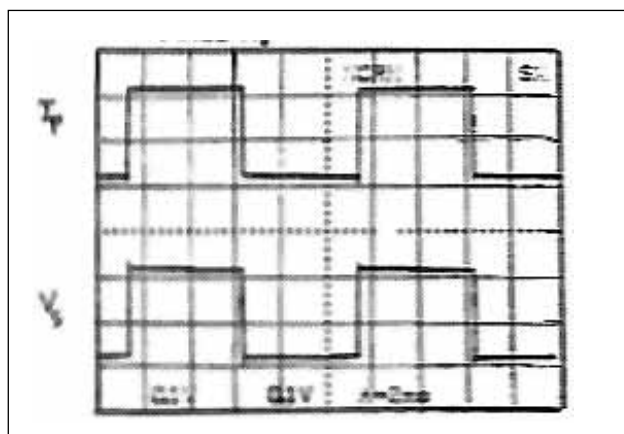

1 kHz

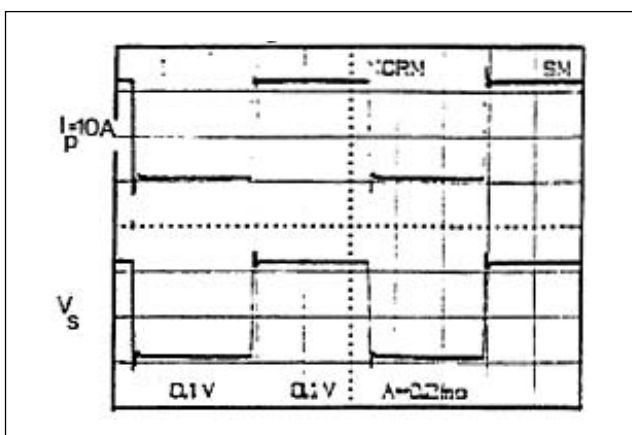

10 kHz

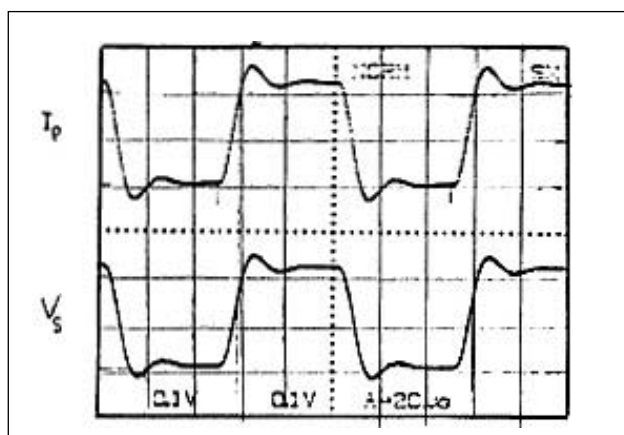

oscilloscope clamp for AC current

model D38N insulated AC current probe

D_N series

■ Influence of a DC current superimposed on the signal

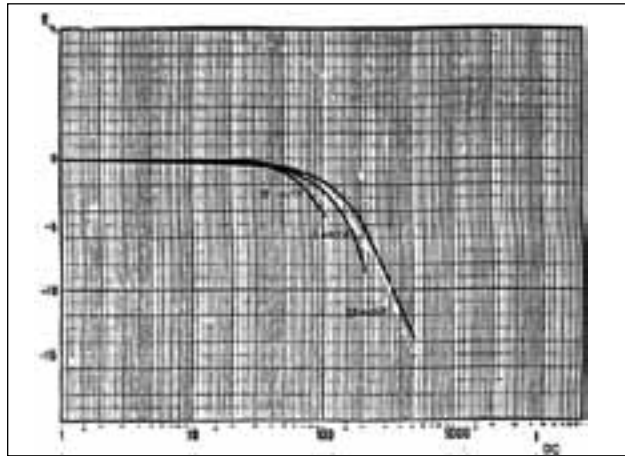

■ Maximum current according to the frequency

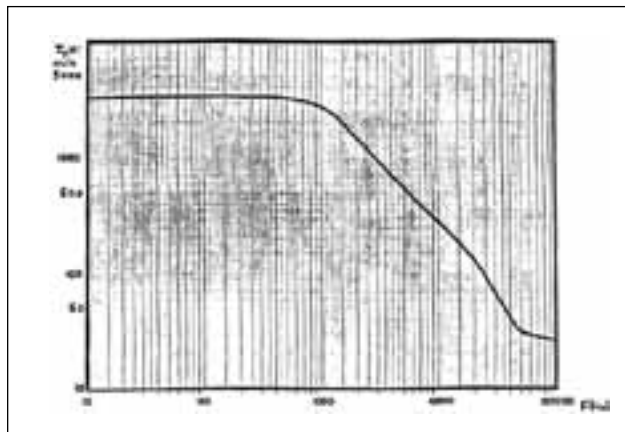

(1) Conditions of reference: 23 °C ± 3 °K, 20 % to 75 % RH, sinusoidal signal with frequency of 48 Hz at 65 Hz, external magnetic field < 40 A/m, no DC components, no external conductor with circulating current, conductor centred for measurement, load impedance >1 MΩ / < 47 pF.

(2) Out of reference domain.

To order	Reference
AC current clamp model D38N for oscilloscope, with operating manual	P01120057A



B series

The only model in the B series, the B102 is designed to measure earth leakage currents caused by insulation faults. It enables the fault to be located and diagnosed before failure occurs thus avoiding installation shutdown.

It is designed specifically for locating low-current faults on high-current circuits.

The B102 measures differential or leakage current from 500 μ A upwards and may be used to measure currents up to 400 A in continuous use (400 A max.).

The B102 has two measurement ranges, 1 mV/mA or 1 mV/A.

As a leakage current detector, the B102 can be used on single or multiphase systems whether the currents are in or out of phase, balanced or unbalanced.

The B02 may be used simply as a high-precision clamp-on current probe.

With its 115 mm jaw opening and dynamic measurement range from 500 μ A to 400 A, the B102 is a versatile instrument, highly useful in the analysis of unbalanced circuits, leakage currents and earth loop currents.

When operated in conjunction with an artificial neutral, the B102 can also be used to measure fault currents on 3-phase circuits with no neutral.

(1) AN1 artificial neutral box (see chapter 12)

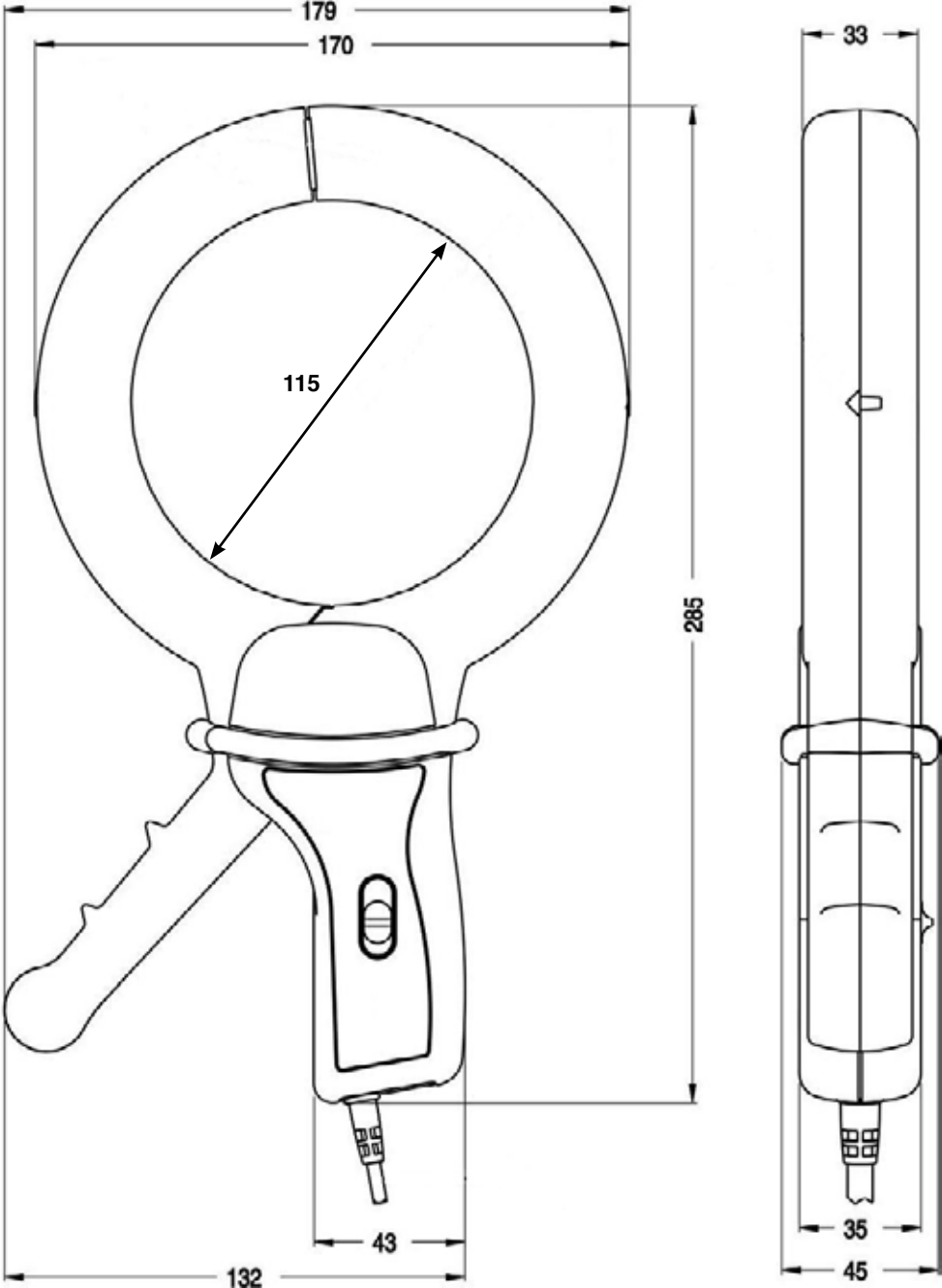

Current clamp for AC current

odel “ ” clamp for leakage currents

B100 series

Current	4 A AC	400 A AC
Output	1 mV/mA	1 mV/A

Description

The B102 clamp measures leakage currents or residual currents as low as 500 μ A and can be used with multimeters equipped with a calibre in mV AC.

The B102 clamp measures the currents flowing in earth loops as well as leakage currents. It can be used on live installations to detect insulation faults on the earth circuits of single and three-phase networks.

For three-wire three-phase systems, use the artificial neutral box.

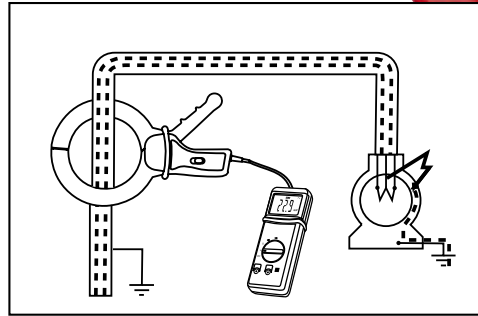

Electrical specifications

Current calibres:

0.5 mA AC...4 A AC
0.5 A AC ...400 A AC

Output signal:

1 mV AC / mA AC (4 V for 4 A)
1 mV AC / A AC (0.4 V for 400 A)

Accuracy and phase shift ⁽¹⁾:

Calibre	4 A		
Primary current	0.5 mA...10 mA	10 mA...100 mA	100 mA...4 A
Accuracy in % of output signal	$\leq 3\% + 1\text{ mV}$	$\leq 0.5\% + 0.5\text{ mV}$	$\leq 0.5\% + 0.5\text{ mV}$
Phase shift	not specified	$\leq 15^\circ$	$\leq 10^\circ$

Calibre	400 A		
Primary current	0.5 mA...10 mA	10 A...200 A	200 A...400 A
Accuracy in % of output signal	$\leq 0.5\% + 0.5\text{ mV}$	$\leq 0.35\% + 0.5\text{ mV}$	$\leq 0.35\% + 0.5\text{ mV}$
Phase shift	not specified	$\leq 1^\circ$	$\leq 0.7^\circ$

Bandwidth:

30 kHz ...1 kHz (depending on current value)

Maximum currents:

400 A AC continuous for a frequency ≤ 1 kHz:
Peak current < 1000 A

Max. voltage output:

Electronic protection limiting the voltage to 6 Vpeak max.

Influence of temperature:

Measurement: ≤ 100 ppm/K or 0.1 % of output signal per 10 °K

Influence of adjacent conductor:

0.4 mA/A typical at 50 Hz

Influence of an external field:

4 A calibre: ≤ 60 mA

400 A calibre: ≤ 0.1 A

for 400 A/m calibre at 50 Hz

Influence of conductor position in jaws:

≤ 0.1 % of the reading at 50/60 Hz (non-residual current)

≤ 0.2 % of the reading at 50/60 Hz (residual current)

Influence of a DC current superimposed on the rated AC current:

4 A calibre: ≤ 1 mA

400 A calibre: ≤ 0.1 A

for a current DC of 1 A

Influence of frequency:

4 A calibre: $\leq 2\%$

400 A calibre: $\leq 0.5\%$ from 30 Hz to 1 kHz (limited to 100 A for 1 kHz)

Influence of the measurement instrument's input impedance:

4 A calibre:

$E\% = [Ze/(Ze + 4.8) - 1] * 100$

400 A calibre:

$E\% = [Ze/(Ze + 0.0048) - 1] * 100$

Mechanical specifications

Operating temperature:

-10 °C to +55 °C

Storage temperature:

-40 °C to +70 °C

Max. jaw insertion capacity:

Cables: \varnothing 115 mm

Bars: 1 busbar 20 x 50 mm

Casing protection rating:

IP 40 with clamp closed (NF EN 60529 Ed. 95)

IP 30 with jaws open

Relative humidity for operation:

0 to 85 % RH with a linear decrease above 35°C

Operating altitude:

0 to 2,000 m

Drop test:

1 m (NF EN 61010-2-032)

Self-extinguishing capability:

Casing: V0 according to UL94

Jaws: V2 according to UL94

Dimensions:

285 x 175 x 43 mm

Weight:

1.3 kg approx.

Colours:

Casing: dark grey

Jaws: red

Output:

Cable with double insulation, length 1.5 m, terminated by 2 insulated elbowed male \varnothing 4 mm banana plugs

Safety specifications

Electrical safety:

Instrument with double insulation or reinforced insulation between the primary, the secondary and the grippable part located under the guard as per EN 61010-1 Ed. 2: 2001, EN 61010-2-031 Ed. 2002 & EN 61010-2-032 Ed. 2003

- 600 V category III, pollution degree 2

- 300 V category IV, pollution degree 2

Electromagnetic compatibility:

CE-certified equipment compliant with standard EN 61326-1 (Ed. 97) + A1 (Ed. 98) + A2 (Ed. 01)

- Emission: regulations for class B equipment (domestic use)

- Immunity: regulations for equipment operated intermittently on industrial sites

Current clamp for AC current

Model " " clamp for leakage currents

B100 series

Curves at 50 Hz

4 A calibre

400 A calibre

Linearity for AC

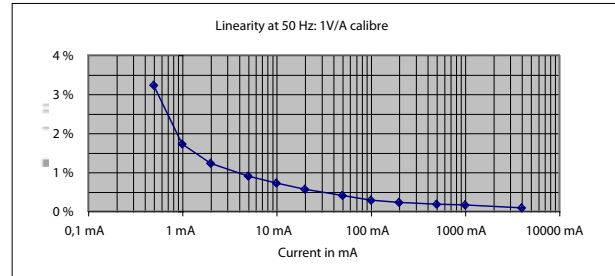
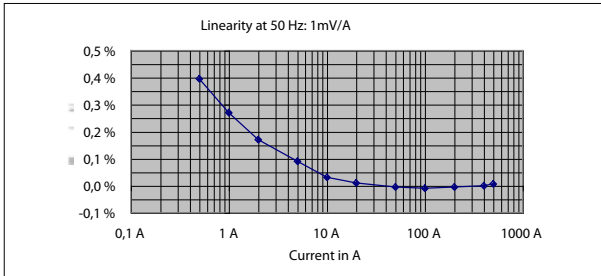

Phase shift

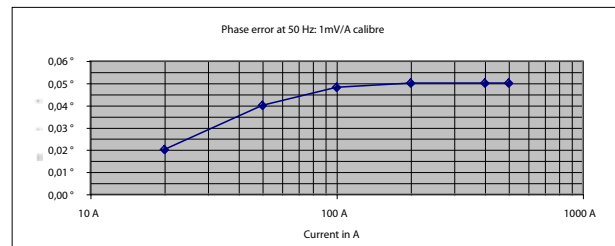
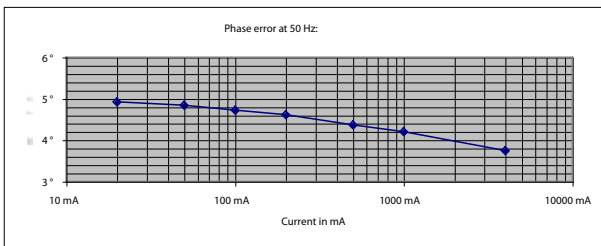

Frequency response

4 A calibre

400 A calibre

Typical error on measurement

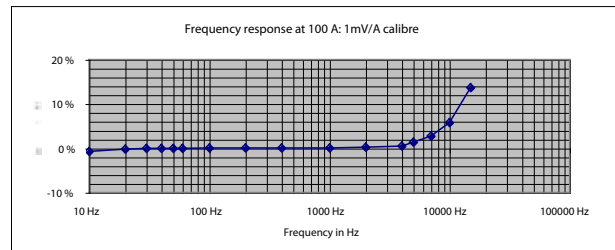
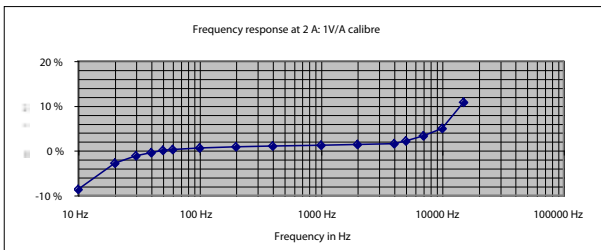

Phase shift typical

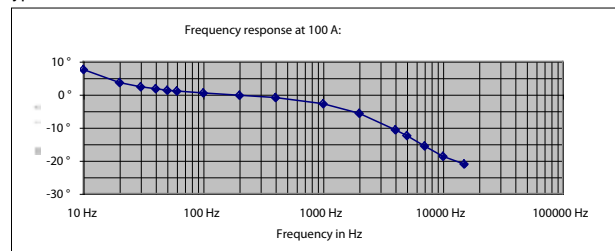
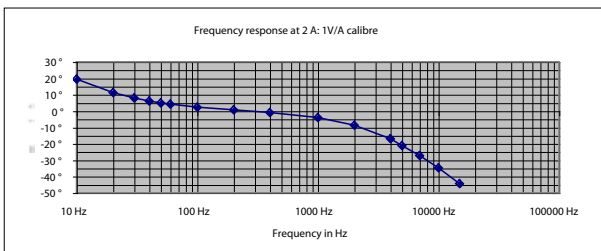

(1) Conditions of reference: 23 °C ± 3 °K, 20 % to 75 % RH, sinusoidal signal with frequency of 48 to 65 Hz, distortion factor < 1 %, no DC components, external magnetic field < 40 A/m, no AC magnetic field, no external conductor with current flowing, conductor centred for measurement, load impedance ≥ 10 MΩ / ≤ 100 pF.

To order	Reference
AC current clamp model B102 with operating manual	P01120033
Accessories: AN1 artificial neutral box (see chapter 12)	P01197201
Bag No. 11	P01100120



MiniFLEX series

Making use of the principle of Rogowski coils, the MiniFLEX models are flexible sensors offering a wide dynamic range for measuring AC currents and viewing high-speed current pulses.

The sensor's output voltage is proportional to the derivative of the current measured in the conductor and requires an electronic system for formatting.

The absence of a magnetic core at the centre of the coil brings several advantages:

- flexibility and light weight
- excellent response to rapid current changes, as it is not possible for induced Fourier currents to occur, so they do not increase the sensor's response time.
- excellent linearity due to the absence of core saturation even when there are very high current, as in the case of electric power transmission, electrical welding or applications involving high-power pulses.

The great care taken when manufacturing our sensors means they benefit from particularly homogeneous winding, with equidistant turns along the whole length of the sensor, thus ensuring good immunity against electromagnetic interference.

The MiniFLEX models are made up of a flexible sensor connected to a casing containing processing electronics which outputs a voltage with the same amplitude and form as the current measured.

MiniFLEX MA100 series:

With their small diameter and size, the sensors in the MA100 series are ideal for measuring currents in the electrical cabinets of residential or tertiary buildings or in low-power cabinets in industry.

Available with "banana" or "BNC" connection technology, the MA100 series can be connected directly to a multimeter, a wattmeter or a logger for RMS measurements at the standard industrial frequencies.

MiniFLEX MA200 series:

The MA200 series is a family of "high-frequency" sensors specially designed for viewing and measuring electrical or electrotechnical signals with wide variations and high amplitude.

These "insulated current probes for oscilloscopes" offer a bandwidth of 1 MHz and can be used to analyse currents with complex forms, transients present in electronic power supplies, welding units, etc.

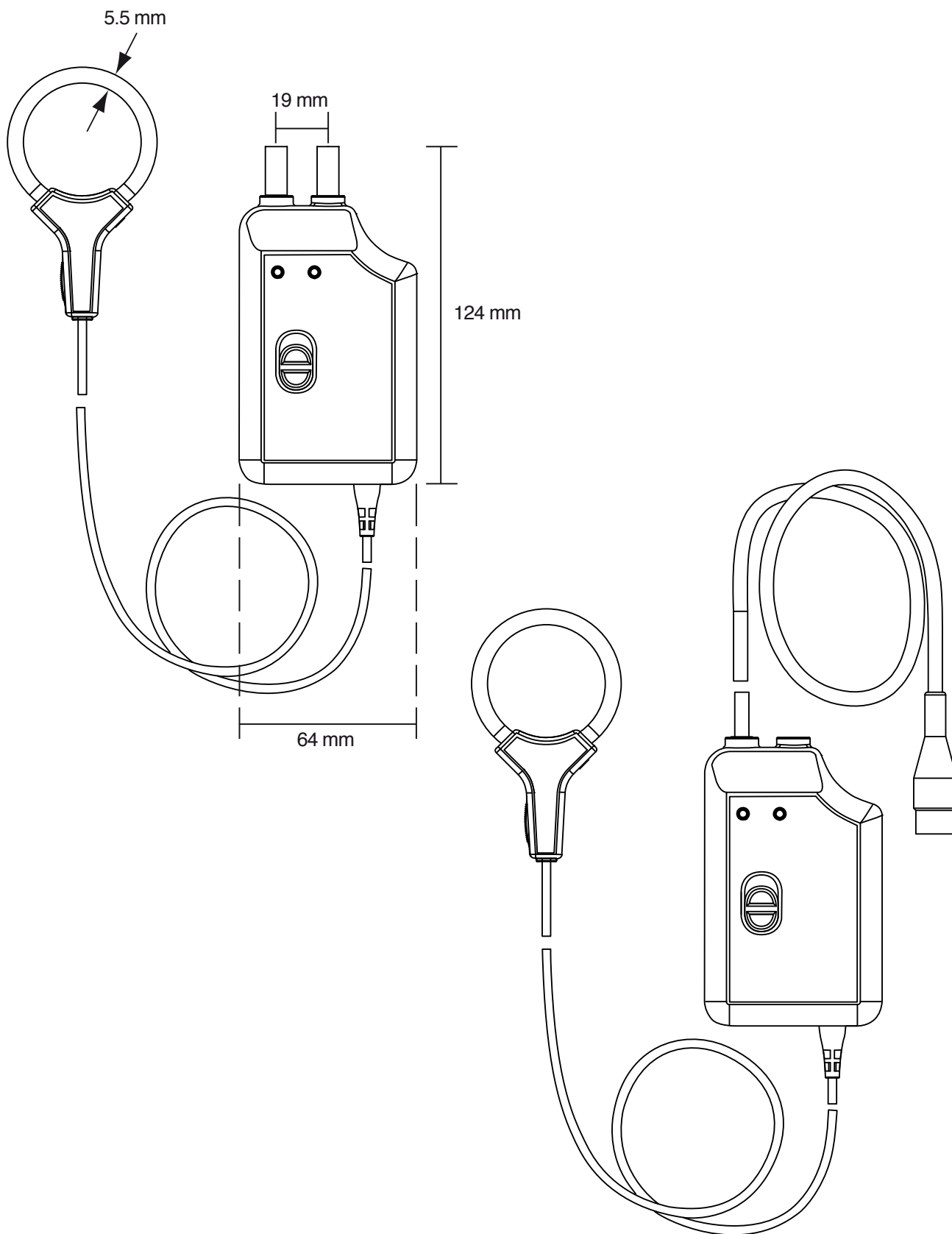

flexible probe for AC current

odel A“

MiniFLEX series

Current	30 A AC	300 A AC
Output	100 mV/A	10 mV/A

Description

The model MA100 MiniFLEX sensor is a flexible sensor comprising an active part (Rogowski coil) linked to a casing containing electronics.

Unlike a current clamp with magnetic circuits, the MiniFLEX models are flexible and are not subject to magnetic saturation constraints, so they offer excellent linearity, low phase shift and a large dynamic range for measurement (up to several kA) while remaining easy to use.

The sensors' flexibility makes it simple to clamp and measure any conductor, whatever its type (cable, busbar, strand, etc. and accessibility).

The click-lock system for opening and closing the coil is specially designed for use with safety gloves.

Depending on the model, the MA100 can be connected to the AC voltage input of:

- any multimeter with Ø 4 mm female plugs with 19 mm spacing
- any measurement instrument equipped with BNC connection technology.



Specifications for current measurement ⁽¹⁾

Calibre	30 A	300 A
Measurement range in use	0.5...30 A AC	0.5...300 A AC
Specified measurement range ⁽²⁾	5...30 A AC	5...300 A AC
Output/input ratio	100 mV/A	10 mV/A
Bandwidth at -3 dB	2 Hz...20 kHz	
Accuracy in % of output signal	≤ 1 %	
Phase shift at 50 Hz	≤ 1.5°	
Residual current (noise) at I = 0	≤ 0.5 A rms	
Output impedance	1 kΩ	

flexible probe for AC current

odel A⁴

MiniFLEX series

■ Electrical specifications ⁽¹⁾

Operating voltage:

600 V rms (Cat. IV)
1000 V rms (Cat. III)

Battery:

9 V alkaline battery (NEDA 1604A, IEC 6LR61)

Battery life:

100 hours typical

Typical consumption:

3.6 mA typical

Battery level indication:

Green LED when > 7.0 V approx.

Influence of battery voltage:

≤ 0.1 % from 9 V to 7 V

Influence of temperature:

≤ 0.2 % / 10 °K

Influence of humidity:

≤ 0.3 % from 10 % to 90 % RH without condensation

Influence of conductor position in the sensor ⁽⁵⁾:

≤ 2.5 %

Influence of sensor deformation ⁽³⁾:

≤ 1.5 %

Influence of an adjacent conductor with circulating AC current ⁽⁴⁾:

≤ 1 % or 40 dB

Common mode rejection:

- between enclosure and secondary:

≤ 65 dB

- between sensor and secondary: ≤ 88 dB

Influence of the measurement instrument's impedance Z:

0.1 % / Z (in MΩ)

■ Mechanical specifications

Clamping capacity:

Model 170 mm: Ø max 45 mm

Operating temperature:

-10 °C to +55 °C

Storage temperature:

-40 °C to +70 °C

Max. temperature of clamped conductor (measured):

≤ 90 °C

Relative humidity for operation:

0 to 85 % RH with a linear decrease above 35 °C

Operating altitude:

0 to 2,000 m

Storage altitude:

≤ 12,000 m

Casing protection rating (leakproofing):

Casing: IP50

Sensor: IP50

according to EN 60529/A1 Ed.06/2000

Shock resistance:

IK04 according to EN 50102 Ed.1995

Self-extinguishing capability:

Casing: UL94-V2

Sensor: UL94 V0

Dimensions:

Casing: 140 x 64 x 28 mm

Connector lead: 2 m (connects sensor to casing)

Ø of sensor: 5.5 mm approx.

Connection cable Ø: 3 mm approx.

Colours:

Sensor: red

Sensor closing system: dark grey

Sensor locking tab: yellow

Casing: dark grey

Output:

Depending on model:

- 2 x Ø 4 mm safety plugs with 19 mm spacing or

- Coaxial cable 40 cm long, terminated by an insulated BNC plug

■ Safety specifications

Electrical safety:

Class II equipment with double or reinforced insulation between the primary and the secondary (winding connected to the connection cable) as per EN 61010-1 and 61010-2-032:

- 1000 V Cat. III, pollution degree 2

- 600 V Cat. IV, pollution degree 2

- Type-B sensor

- 600 V Cat. III between the terminals or between the BNC output (depending on model) and the external enclosure of the casing

Electromagnetic compatibility (EMC):

Complies with the IEC 61326 (Ed. 1997) + A1 (Ed. 1998)

- Adequate immunity to disturbances for industrial environments

- Adequate immunity to disturbances for residential environments

(1) Conditions of reference: 23 °C ± 5 °K, 20 % to 75 % RH

Battery voltage: 9 V ± 0.5 V

Continuous external DC magnetic field (earth field) < 40 A/m

Absence of external AC magnetic field

External electrical field < 1 V/m

Position of conductor measured: centred in the measurement coil

Shape of measurement coil: quasi-circular

Measurement instrument input impedance (oscilloscope) ≥ 1 MΩ

Frequency and form of signal measured: 40 to 400 Hz sinusoidal.

(2) Measurement range for the specifications indicated in this document

(3) Any position, Ø of conductor measured ≥ 5 mm

(4) Adjacent conductor 1 cm from sensor, ≤ 2 % or 34 dB near click-lock system

(5) ≤ 6 % near click-lock system

To order	Reference
MiniFLEX MA100 30-300 A / 3 V, length 170 mm, output via 2 x Ø 4 mm safety plugs with 19 mm spacing, with operating manual and battery	P01120560
MiniFLEX MA100 30-300 A / 3 V, length 170 mm, insulated BNC output with BNC Ø 4 mm banana adapter, with operating manual and battery	P01120563

flexible probe for AC current

odel A“

MiniFLEX series

Current	300 A AC	3000 A AC
Output	10 mV/A	1 mV/A

■ Description

The MiniFLEX MA100 sensor is a flexible sensor comprising an active part (Rogowski coil) linked to a casing containing electronics.

Unlike a current clamp with magnetic circuits, the MiniFLEX models are flexible and are not subject to magnetic saturation constraints, so they offer excellent linearity, low phase shift and a large dynamic range for measurement (up to several kA) while remaining easy to use.

The sensors' flexibility makes it simple to clamp and measure any conductor, whatever its type (cable, busbar, strand, etc. and accessibility).

The click-lock system for opening and closing the coil is specially designed for use with safety gloves.

Depending on the model, the MA100 can be connected to the AC voltage input of:

- any multimeter with Ø 4 mm female plugs with 19 mm spacing
- any measurement instrument equipped with BNC connection technology.



■ Specifications for current measurement ⁽¹⁾

Calibre	300 A	3000 A
Measurement range in use	0.5...300 A AC	0.5...3000 A AC
Specified measurement range ⁽²⁾	5...300 A AC	5...3000 A AC
Output/input ratio	10 mV/A	1 mV/A
Bandwidth at -3 dB ⁽⁶⁾	2 Hz...20 kHz	
Accuracy in % of output signal	≤ 1 %	
Phase shift at 50 Hz	≤ 1.5°	
Residual current (noise) at I = 0	≤ 0.5 A rms	
Output impedance	1 kΩ	

flexible probe for AC current

odel A⁴

MiniFLEX series

Electrical specifications ⁽¹⁾

Operating voltage:

600 V rms (Cat. IV)
1000 V rms (Cat. III)

Battery:

9 V alkaline battery (NEDA 1604A, IEC 6LR61)

Battery life:

100 hours typical

Typical consumption:

3.6 mA typical

Battery level indication:

Green LED when > 7.0 V approx.

Influence of battery voltage:

≤ 0.1 % from 9 V to 7 V

Influence of temperature:

≤ 0.2 % / 10 K

Influence of humidity:

≤ 0.3 % from 10 % to 90 % RH without condensation

Influence of conductor position in the sensor ⁽⁵⁾:

≤ 2.5 %

Influence of sensor deformation ⁽³⁾:

≤ 1.5 %

Influence of an adjacent conductor with circulating AC current ⁽⁴⁾:

≤ 1 % or 40 dB

Common mode rejection:

- between enclosure and secondary: ≤ 65 dB
- between sensor and secondary: ≤ 88 dB

Influence of the measurement instrument's impedance Z:

0.1 % / Z (in MΩ)

Mechanical specifications

Clamping capacity:

Model 250 mm: Ø max 70 mm
Model 350 mm: Ø max 100 mm

Operating temperature:

-10 °C to +55 °C

Storage temperature:

-40 °C to +70 °C

Max. temperature of clamped conductor (measured):

≤ 90 °C

Relative humidity for operation:

0 to 85 % RH with a linear decrease above 35 °C

Operating altitude:

0 to 2,000 m

Storage altitude:

≤ 12,000 m

Casing protection rating (leakproofing):

Casing: IP50
Sensor: IP50
according to EN 60529/A1 Ed.06/2000

Shock resistance:

IK04 according to EN 50102 Ed. 1995

Self-extinguishing capability:

Casing: UL94-V2
Sensor: UL94 V0

Dimensions:

Casing: 140 x 64 x 28 mm
Connector lead: 2 m (connects sensor to casing)
Ø of sensor: 5.5 mm approx.
Connection cable Ø: 3 mm approx.

Colours:

Sensor: red
Sensor closing system: dark grey
Sensor locking tab: yellow
Casing: dark grey

Output:

Depending on model:
- 2 x Ø 4 mm safety plugs with 19 mm spacing or
- Coaxial cable 40 cm long, terminated by an insulated BNC plug

Safety specifications

Electrical safety:

Class II equipment with double or reinforced insulation between the primary and the secondary (winding connected to the connection cable) as per EN 61010-1 and 61010-2-032:
- 1000 V Cat. III, pollution degree 2
- 600 V Cat. IV, pollution degree 2
- Type-B sensor
- 600 V Cat. III between the terminals or between the BNC output (depending on model) and the external enclosure of the casing

Electromagnetic compatibility (EMC):

Complies with the IEC 61326 (Ed. 1997) + A1 (Ed. 1998)
- Adequate immunity to disturbances for industrial environments
- Adequate immunity to disturbances for residential environments

(1) Conditions of reference: 23 °C ± 5 °K, 20 % to 75 % RH

Battery voltage: 9 V ± 0.5 V

Continuous external DC magnetic field (earth field) < 40 A/m

Absence of external AC magnetic field

External electrical field < 1 V/m

Position of conductor measured: centred in the measurement coil

Shape of measurement coil: quasi-circular

Measurement instrument input impedance (oscilloscope) ≥ 1 MΩ

Frequency and form of signal measured: 40 to 400 Hz sinusoidal.

(2) Measurement range for the specifications indicated in this document

(3) Any position, Ø of conductor measured ≥ 5 mm

(4) Adjacent conductor 1 cm from sensor, ≤ 2 % or 34 dB near click-lock system

(5) ≤ 6 % near click-lock system

(6) Frequency limitation according to amplitude

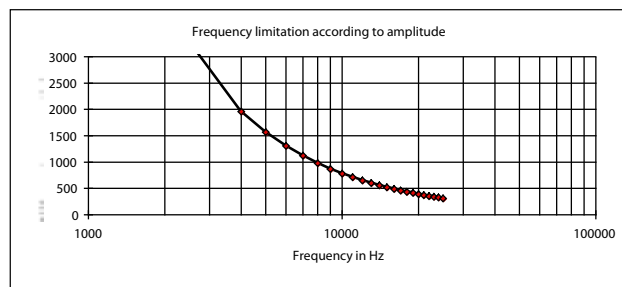

To order	Reference
MiniFLEX MA100 300-3000 A / 3 V, length 250 mm, output via 2 x Ø 4 mm safety plugs with 19 mm spacing, with operating manual and battery	P01120561
MiniFLEX MA100 300-3000 A / 3 V, length 350 mm, output via 2 x Ø 4 mm safety plugs with 19 mm spacing, with operating manual and battery	P01120562
MiniFLEX MA100 300-3000 A / 3 V, length 250 mm, insulated BNC output with BNC Ø 4 mm banana adapter, with operating manual and battery	P01120564
MiniFLEX MA100 300-3000 A / 3 V, length 350 mm, insulated BNC output with BNC Ø 4 mm banana adapter, with operating manual and battery	P01120565

odel A''

insulated AC current probe

Current	45 A peak	450 A peak
Output	100 mV/A	10 mV/A

Description

The MiniFLEX MA200 is a flexible sensor comprising an active part (Rogowski coil) linked to a casing containing electronics.

Unlike a current clamp with magnetic circuits, the MiniFLEX models are flexible and are not subject to magnetic saturation constraints, so they offer excellent linearity, low phase shift and a large dynamic range for measurement (up to several kA) while remaining easy to use.

The oscilloscope probes in the MA200 series are specially designed for viewing alternating currents in order to assess the transition and propagation times on electrotechnical equipment.

The sensors' flexibility makes it simple to clamp and measure any conductor, whatever its type (cable, busbar, strand, etc. and accessibility).

The click-lock system for opening and closing the coil is specially designed for use with safety gloves.

The casing can be connected to any oscilloscope equipped with an AC voltage input.



Specifications for current measurement ⁽¹⁾

Calibre	30 A	300 A
Measurement range in use	0.5...30 A AC (45 A peak)	0.5...300 A AC (450 A peak)
Specified measurement range ⁽²⁾	5...30 A AC (45 A peak)	5...300 A AC (450 A peak)
Output/input ratio	100 mV/A	10 mV/A
Accuracy in % of output signal	≤ 1 % + 0.3 A	
Phase shift at 1 kHz	≤ 1.5°	
Residual current (noise) at I = 0	≤ 0.5 A rms	
Output impedance	1 kΩ	

Frequency measurement specifications ⁽¹⁾

Calibre	30 A	300 A
Bandwidth at -3 dB	2 Hz...1 MHz	2 Hz...1 MHz
Rise time ⁽³⁾ (10 to 90 %)	0.3 μs (typical)	0.24 μs (typical)
Fall time ⁽⁴⁾ (10 to 90 %)	0.3 μs (typical)	0.24 μs (typical)
Propagation time ⁽⁵⁾ (to 10 %)	0.4 μs (typical)	0.3 μs (typical)
Insertion impedance at 10 kHz	< 0.05 mΩ	



odel A''

insulated AC current probe

■ Electrical specifications ⁽¹⁾

Operating voltage:

600 V rms (Cat. IV)
1000 V rms (Cat. III)

Battery:

9 V alkaline battery (NEDA 1604A, IEC 6LR61)

Battery life:

100 hours typical

Typical consumption:

3.6 mA typical

Battery level indication:

Green LED when > 7.0 V approx.

Influence of battery voltage:

≤ 0.1 % from 9 V to 7 V

Influence of temperature:

≤ 0.2 % / 10 K

Influence of humidity:

≤ 0.5 % from 10 % to 90 % RH without condensation

Influence of conductor position in the sensor ⁽⁸⁾:

≤ 2.5 %

Influence of sensor deformation ⁽⁶⁾:

≤ 1 %

Influence of an adjacent conductor with circulating AC current (7):

≤ 1.5 % or 36.5 dB

Common mode rejection:

- between enclosure and secondary:
≤ 75 dB
- between sensor and secondary: ≤ 80 dB

Influence of the measurement instrument's impedance Z:

0.1 % / Z (in MΩ)

■ Mechanical specifications

Clamping capacity:

Model 170mm: Ø max 45 mm
Model 250mm: Ø max 70 mm

Operating temperature:

-10 °C to +55 °C

Storage temperature:

-40 °C to +70 °C

Max. temperature of clamped conductor (measured):

≤ 90 °C

Relative humidity for operation:

0 to 85 % RH with a linear decrease above 35 °C

Operating altitude:

0 to 2,000 m

Storage altitude:

≤ 12,000 m

Casing protection rating (leakproofing):

Casing: IP50
Sensor: IP50
according to EN 60529/A1 Ed.06/2000

Shock resistance:

IK04 according to EN 50102 Ed. 1995

Self-extinguishing capability:

Casing: UL94-V2
Sensor: UL94 V0

Dimensions:

Casing: 140 x 64 x 28 mm
Connector lead: 2 m (connects sensor to casing)
Ø of sensor: 5.5 mm approx.
Connection cable Ø: 3 mm approx.

Colours:

Sensor: red
Sensor closing system: dark grey
Sensor locking tab: yellow
Casing: dark grey

Output:

Depending on model:
Coaxial cable 40 cm long, terminated by an insulated BNC plug

■ Safety specifications

Electrical safety:

Class II equipment with double or reinforced insulation between the primary and the secondary (winding connected to the connection cable) as per EN 61010-1 and 61010-2-032:
- 1000 V Cat. III, pollution degree 2
- 600 V Cat. IV, pollution degree 2
- Type-B sensor
- 600 V Cat. III between the BNC output and the external enclosure of the casing

Electromagnetic compatibility (EMC):

Complies with the IEC 61326 (Ed. 1997) + A1 (Ed. 1998)
- Adequate immunity to disturbances for industrial environments
- Adequate immunity to disturbances for residential environments

(1) Conditions of reference: 23 °C ± 5 °K, 20 % to 75 % RH

Battery voltage: 9 V ± 0.5 V

Continuous external DC magnetic field (earth field) < 40 A/m

Absence of external AC magnetic field

External electrical field < 1 V/m

Position of conductor measured: centred in the measurement coil

Shape of measurement coil: quasi-circular

Measurement instrument input impedance (oscilloscope) ≥ 1 MΩ

Frequency and form of signal measured: 40 to 400 Hz sinusoidal.

(2) Measurement range for the specifications indicated in this document

(3) Rise time (t_r)

(4) Fall time (t_f)

(5) Delay time (t_d)

(6) Oblong shape

(7) Adjacent conductor 1 cm from sensor ; ≤ 3 % or 30.5 dB near click-lock system

(8) ≤ 6 % near click-lock system

(9) Typical curve obtained by mathematical modelling

To order	Reference
MiniFLEX MA200 30-300 A / 3 V, length 170 mm with operating manual and battery	P01120570
MiniFLEX MA200 30-300 A / 3 V, length 250 mm with operating manual and battery	P01120571

odel A''

insulated AC current probe

170 mm loop - 30 A calibre

Frequency and phase responses ⁽⁹⁾

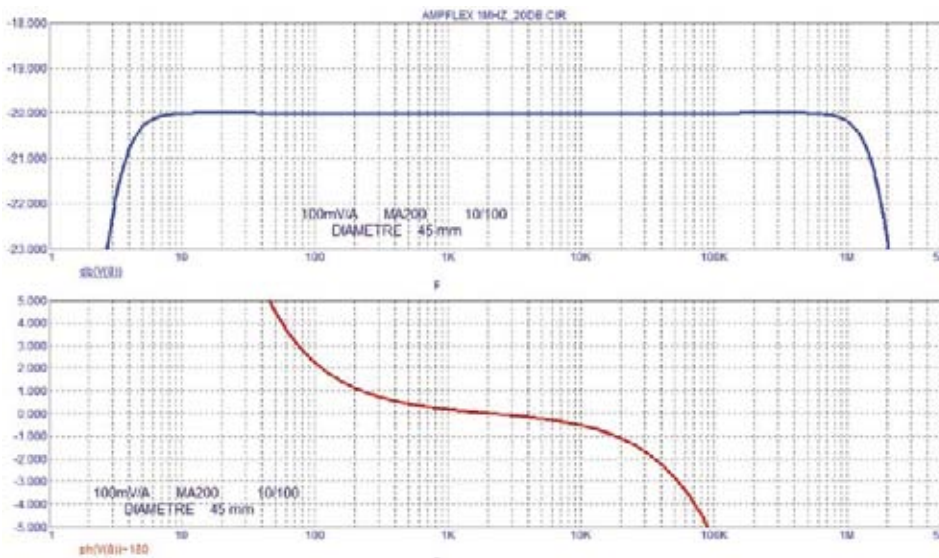

Pulse response

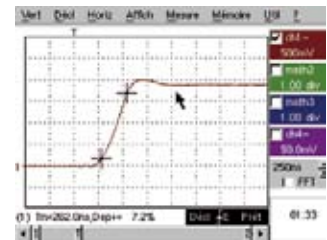

170 mm loop - 300 A calibre

Frequency and phase responses ⁽⁹⁾

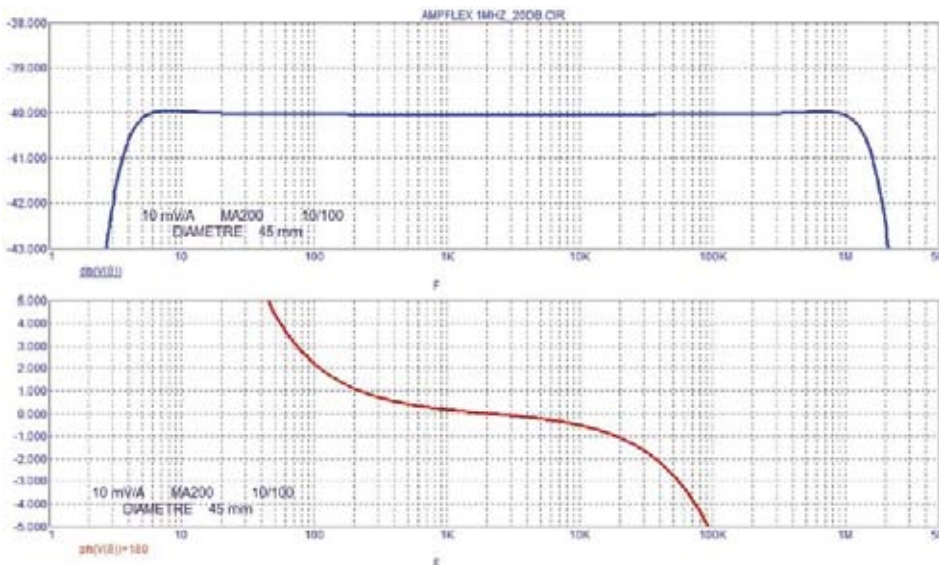

Pulse response

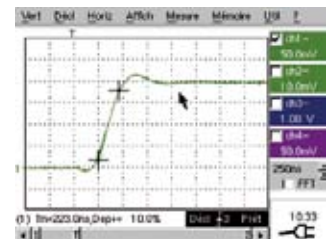

odel A''

insulated AC current probe

■ 250 mm loop - 30 A calibre

Frequency and phase responses ⁽⁹⁾

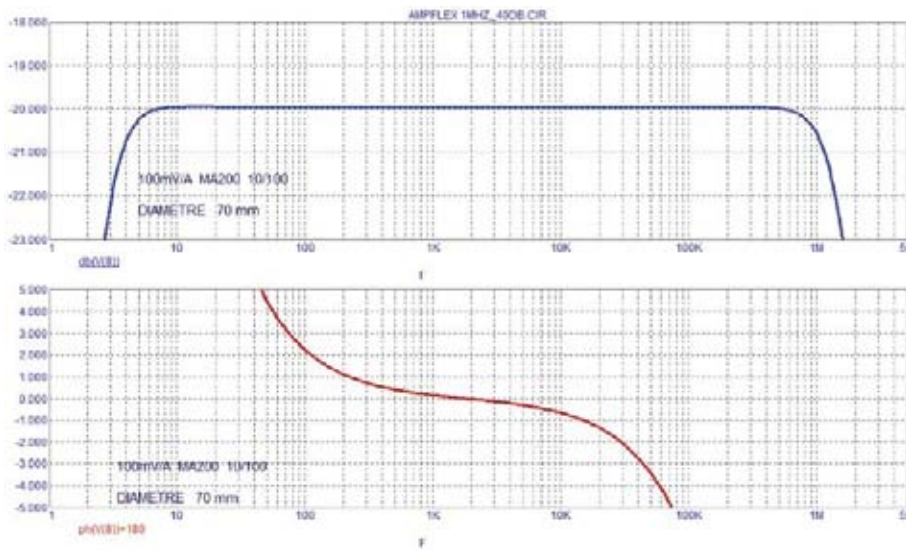

Pulse response

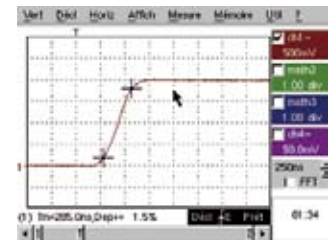

■ 250 mm loop - 300 A calibre

Frequency and phase responses ⁽⁹⁾

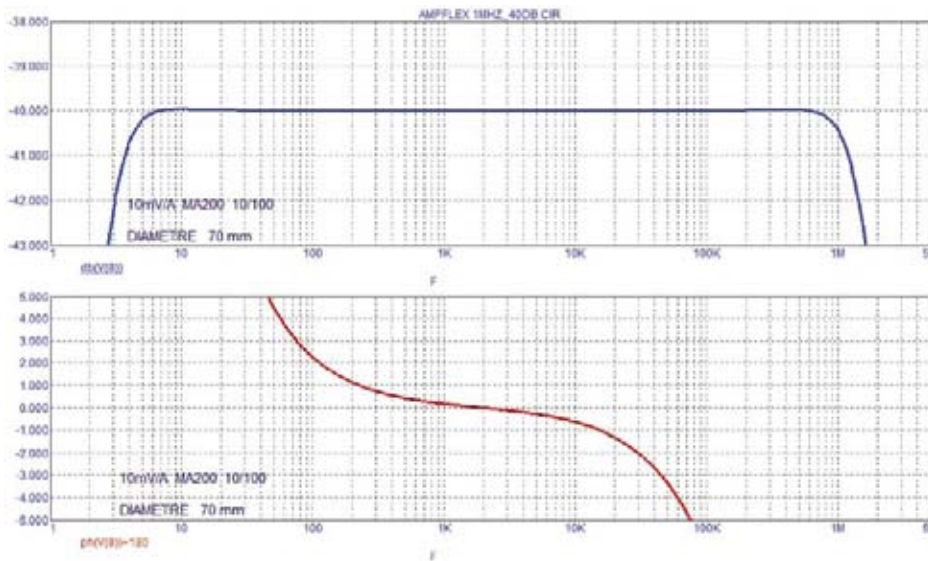

Pulse response

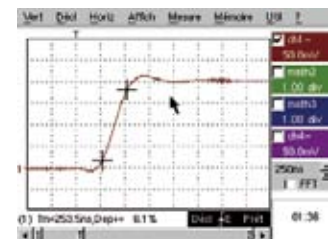

odel A''

insulated AC current probe

Current	4500 A peak
Output	1 mV/A

Description

The MiniFLEX MA200 is a flexible sensor comprising an active part (Rogowski coil) linked to a casing containing electronics.

Unlike a current clamp with magnetic circuits, the MiniFLEX models are flexible and are not subject to magnetic saturation constraints, so they offer excellent linearity, low phase shift and a large dynamic range for measurement (up to several kA) while remaining easy to use.

The oscilloscope probes in the MA200 series are specially designed for viewing alternating currents in order to assess the transition and propagation times on electrotechnical equipment.

The sensors' flexibility makes it simple to clamp and measure any conductor, whatever its type (cable, busbar, strand, etc.) and accessibility.

The click-lock system for opening and closing the coil is specially designed for use with safety gloves.

The casing can be connected to any oscilloscope equipped with an AC voltage input.



Specifications for current measurement ⁽¹⁾

Calibre	3000 A
Measurement range in use	0.5...3000 A AC (4500 A peak)
Specified measurement range ⁽²⁾	5...3000 A AC (4500 A peak)
Output/input ratio	1 mV/A
Accuracy in % of output signal	≤ 1 % + 0.3 A
Phase shift at 1 kHz	≤ 1.5°
Residual current (noise) at I = 0	≤ 0.5 A rms
Output impedance	1 kΩ

Frequency measurement specifications ⁽¹⁾

Calibre	3000 A
Bandwidth at -3 dB ⁽⁶⁾	2 Hz...1 MHz
Rise time ⁽³⁾ (10 to 90 %)	0.3 μs (typical)
Fall time ⁽⁴⁾ (10 to 90 %)	0.3 μs (typical)
Propagation time ⁽⁵⁾ (to 10 %)	0.4 μs (typical)
Insertion impedance at 10 kHz	< 0.05 mΩ

odel A''

insulated AC current probe

■ Electrical specifications ⁽¹⁾

Operating voltage:

600 V rms (Cat. IV)
1000 V rms (Cat. III)

Battery:

9 V alkaline battery (NEDA 1604A, IEC 6LR61)

Battery life:

100 hours typical

Typical consumption:

3.6 mA typical

Battery level indication:

Green LED when > 7.0 V approx.

Influence of battery voltage:

≤ 0.1 % from 9 V to 7 V

Influence of temperature:

≤ 0.6 % / 10 K

Influence of humidity:

≤ 0.5 % from 10 % to 90 % RH without condensation

Influence of conductor position in the sensor ⁽⁹⁾:

≤ 2.5 %

Influence of sensor deformation ⁽⁷⁾:

≤ 1 %

Influence of an adjacent conductor with circulating AC current ⁽⁸⁾:

≤ 1.5 % or 36.5 dB

Common mode rejection:

- between enclosure and secondary: ≤ 75 dB

- between sensor and secondary: ≤ 80 dB

Influence of the measurement instrument's impedance Z:

0.1 % / Z (in MΩ)

■ Mechanical specifications

Clamping capacity:

Model 350mm: Ø max 100 mm

Operating temperature:

-10 °C to +55 °C

Storage temperature:

-40 °C to +70 °C

Max. temperature of clamped conductor (measured):

≤ 90 °C

Relative humidity for operation:

0 to 85 % RH with a linear decrease above 35 °C

Operating altitude:

0 to 2,000 m

Storage altitude:

≤ 12,000 m

Casing protection rating (leakproofing):

Casing: IP50

Sensor: IP50

according to EN 60529/A1 Ed. 06/2000

Shock resistance:

IK04 according to EN 50102 Ed. 1995

Self-extinguishing capability:

Casing: UL94 V2

Sensor: UL94 V0

Dimensions:

Casing: 140 x 64 x 28 mm

Connector lead: 2 m (connects sensor to casing)

Ø of sensor: 5.5 mm approx.

Connection cable Ø: 3 mm approx.

Colours:

Sensor: red

Sensor closing system: dark grey

Sensor locking tab: yellow

Casing: dark grey

Output:

Coaxial cable 40 cm long, terminated by an insulated BNC plug

■ Safety specifications

Electrical safety:

Class II equipment with double or reinforced insulation between the primary and the secondary (winding connected to the connection cable) as per EN 61010-1 and 61010-2-032:

- 1000 V Cat. III, pollution degree 2

- 600 V Cat. IV, pollution degree 2

- Type-B sensor

- 600 V Cat. III between the BNC output and the external enclosure of the casing

Electromagnetic compatibility (EMC):

Complies with the IEC 61326 (Ed. 1997) + A1 (Ed. 1998)

- Adequate immunity to disturbances for industrial environments

- Adequate immunity to disturbances for residential environments

(1) Conditions of reference: 23 °C ± 5 °K, 20 % to 75 % RH
Battery voltage: 9 V ± 0.5 V
Continuous external DC magnetic field (earth field) < 40 A/m
Absence of external AC magnetic field
External electrical field < 1 V/m
Position of conductor measured: centred in the measurement coil
Shape of measurement coil: quasi-circular
Measurement instrument input impedance (oscilloscope) ≥ 1 MΩ
Frequency and form of signal measured: 40 to 400 Hz sinusoidal.

(2) Measurement range for the specifications indicated in this document

(3) Rise time (tr)

(4) Fall time (tf)

(5) Delay time (td)

(6) Frequency limitation according to amplitude

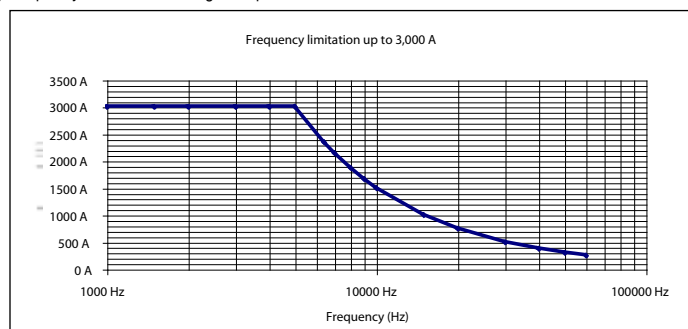

(7) Oblong shape

(8) Adjacent conductor 1 cm from sensor ; ≤ 3 % or 30.5 dB near click-lock system

(9) ≤ 6 % near click-lock system

(10) Typical curve obtained by mathematical modelling

To order	Reference
MiniFLEX MA200 3000 A / 3 V, length 350 mm with operating manual and battery	P01120572

odel A''

insulated AC current probe

■ 3000 A calibre

Frequency and phase responses (10)

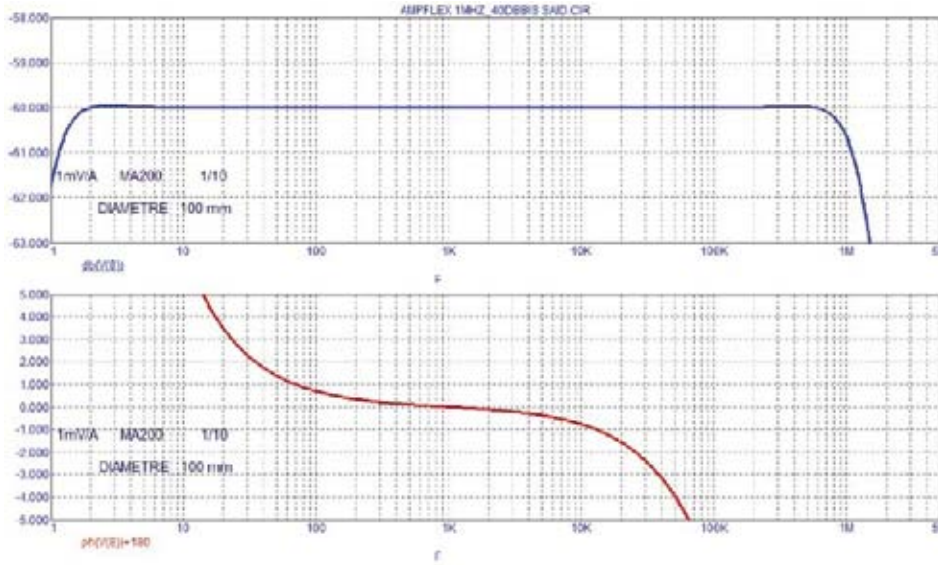

Pulse response

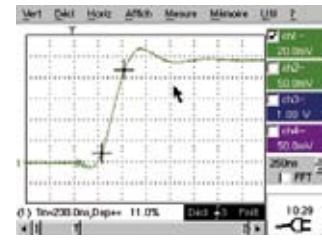

flexible probe for AC current

odel A“ “

MiniFLEX series



these products are only offered under certain conditions quantity etc to manufacturers of measurement location and detection instruments

MiniFLEX sensors offer excellent linearity, low phase shift and a large measurement range (up to several kA), as well as unrivalled simplicity of use. The MA101 series is Chauvin Arnoux's response to all the measurement instrument manufacturers seeking to integrate the MiniFLEX solution as native in their measurement products, particularly for industrial or tertiary applications involving difficult access or confined spaces.



Models produced on request	
Sensor length	From 140 mm
Connection cable length	From 50 cm
Connection	Tinned bare wires, BNC, FRB,...
Pairing	Multi-sensor use,....

Description

The MA 101 MiniFLEX sensor is a flexible sensor comprising an active part (Rogowski coil) and a connection cable. It requires additional electronics (not delivered with the sensor).

For applications where several sensors need to be used (three-phase measurements, etc.), Chauvin Arnoux carries out an additional operation during manufacturing to ensure that they are fully interchangeable.

Electrical specifications ⁽¹⁾

Voltage developed at sensor terminals:
46.5 μ V / A (-15 % / +10 %) at 50 Hz

Linearity ⁽¹⁾:
 ≤ 0.3 %

Phase shift ⁽¹⁾:
 $-90^\circ \pm 0,5^\circ$ at 50 Hz

Bandwidth:
Depends on associated electronics

Interchangeability error:
 ≤ 0.5 % (maximum error between 2 paired sensors on the same measurement point)

Operating voltage:
600 V rms or DC (Cat. IV)
1000 V rms or DC (Cat. III)

Influence of temperature:
0.05 %/10 °K from -20 °C to +60 °C

Influence of humidity:
0.1 % from 10 % to 90 % RH

Influence of conductor position with no sensor deformation:
 ≤ 1.5 %

Influence of adjacent conductor placed 1 cm from sensor:
 ≤ 0.7 % of the adjacent current at 50 Hz

Influence of sensor deformation (flattened/oblong shape): ≤ 0.5 %

Common mode rejection ⁽²⁾:
 ≥ 100 dB for a voltage of 600 V/50 Hz applied between the sensor enclosure and the secondary

Mechanical specifications

Clamping capacity:
Depends on sensor length

Operating temperature:
-20 °C to +60 °C

Storage temperature:
-40 °C to +80 °C

Max. temperature of clamped conductor (measured):
 ≤ 90 °C

Operating altitude:
0 to 2,000 m

Storage altitude:
 $\leq 12,000$ m

Casing protection rating (leakproofing):
IP50 according to EN 60529/A1 Ed.06/2000

Self-extinguishing capability:
UL94 V0

Dimensions:

\varnothing of sensor: 5.5 mm approx.
Connection cable \varnothing : 3 mm approx.

Weight:
30 g approx. per 10 cm length of sensor

Colours:
Sensor: red
Sensor closing system: dark grey
Sensor locking tab: yellow

Connection cable:
Length as requested, with 10 cm increments

Connection:
As requested: specify reference, model and pin configuration required

Safety specifications

Electrical safety:
Class II equipment with double or reinforced insulation between the primary and the secondary (winding connected to the connection cable) as per EN 61010-1 and 61010-2-032:

- 1000 V Cat. III, pollution degree 2
- 600 V Cat. IV, pollution degree 2
- Type-B sensor

Electromagnetic compatibility (EMC):
Not applicable as delivered.
Applicable only for the sensor with its associated electronics which must include EMC protection systems.
The sensor does not contain any EMC protection systems (as it is by nature an electromagnetic field sensor).

(1) Conditions of reference: 23 °C \pm 5 °K, 20 to 75 % RH, continuous external magnetic field < 40 A/m, absence of magnetic and electrical fields, frequency of signal measured 10 Hz to 100 Hz sinusoidal
(2) Ratio expressed in dB to be converted into the equivalent in Amperes while taking into account the sensor's sensitivity and the gain of the associated electronics.

To receive a quotation, please answer the following questions:	
What sensor length do you require? (140 mm minimum, with 10 mm increments) mm
What connection cable length do you require? (50 cm minimum, with 10 cm increments) cm
What connection system do you require? (the output from the sensor comprises 2 active conductors (hot point, cold point) and shielding)	None (tinned bare wires) or Specify connector reference, model and manufacturer and the wiring required
Does your application use several MA 101 sensors? If YES, is sensor interchangeability required?	YES / NO YES / NO
If YES, what is the input impedance of the equipment to which the MA 101 will be connected? Ω



AmpFLEX™ series

These flexible current probes are as at home measuring low AC currents of a few hundred mA as they are measuring high currents of several tens of kA.

Their main point of interest is their flexibility and the ease with which electrical conductors of all shapes and sizes (cables, busbars) and degrees of accessibility can be gripped.

They have a number of other advantages; they are lightweight (no magnetic circuit), they do not suffer from the saturation effect and their high level of accuracy combined with minimal phase shift make them perfect for power measurement applications.

AmpFLEX™ A100 series:

The A100 (pictured above) has a flexible toroid which connects, via a screened lead, to a small unit containing all the processing electronics and a standard 9 V battery.

The unit can be connected directly to any multimeter, wattmeter or recording device. With either one or two calibres, the A100 models give an AC voltage output of 0.1 - 1 - 10 or 100 mV/A. As well as the standard models (45, 80, or 120 cm's), there are also models available on request for which you can choose the sensor length and sensitivity.

AmpFLEX™ A101 series:

The A101 has exactly the same specification as the A100 models but comes without the electronic unit. These sensors are used by other manufacturers and integrated into their own test and measurement products.

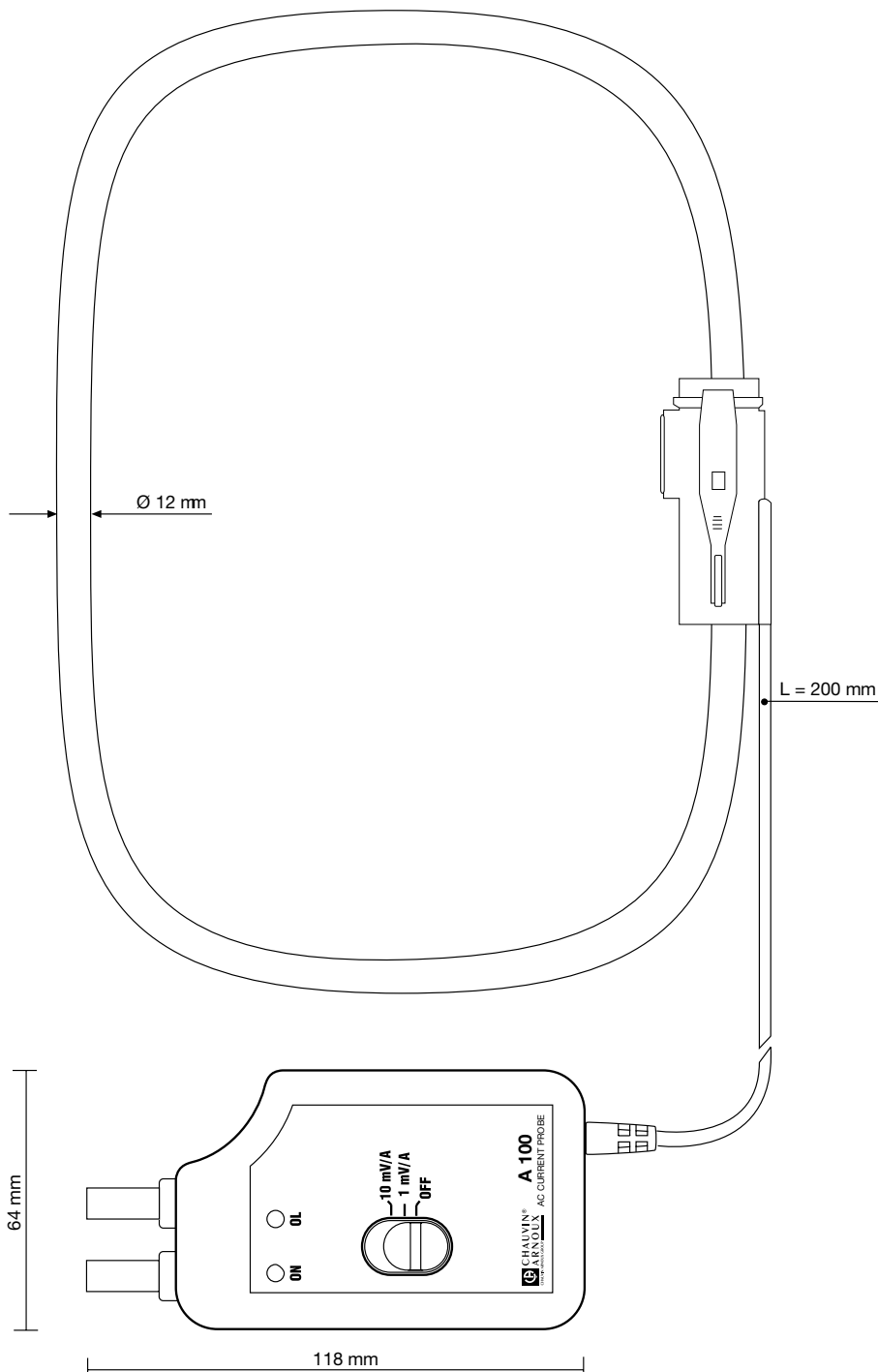

flexible probe for AC current

odel A“ ” ” ”

AmpFLEX™ series

Current	20 A AC	200 A AC
Output	100 mV/A	10 mV/A

Electrical specifications

Current calibres:

0.5 A AC ... 20 A AC

0.5 A AC ... 200 A AC

Output signal:

100 mVAC/A AC (2 V for 20 A)

10 mVAC/A AC (2 V for 200 A)

Accuracy ⁽¹⁾:

Calibre	20 A		200 A	
	Primary current	0.5 A...5 A	5...20 A	0.5 A...5 A
% Accuracy of output signal	not specified	≤ 1 %	not specified	≤ 1 %
Phase shift	≤ 1.3°	≤ 1.3°	≤ 1.3°	≤ 1.3°

Bandwidth:

10 Hz ... 20 kHz

Crest factor:

2.25 at rated current

Max. current / Max. output voltage:

No current limit, but maximum output is 4.5 V peak

Load impedance:

≥ 1 MΩ

Influence of Z load impedance:

≤ 0.1 % / Z, (Z in MΩ)

Output impedance:

1 kΩ

DC voltage shift at output:

■ 20 A calibre: ≤ 50 mV DC

■ 200 A calibre: ≤ 5 mV DC

Operating voltage:

1000 V rms

Influence of adjacent conductor:

≤ 1 % interference current at 50 Hz

(≤ 2 % near click-lock system)

Influence of conductor position in loop:

≤ 1 % (≤ 4 % near click-lock system)

Influence of sensor shape:

≤ 1 % for an oblong shape

Battery:

9 V alkaline battery (NEDA 1604A, IEC 6LR61)

Battery life:

≥ 150 hrs continuous,

≥ 1000 x 1 minute measurements

Low battery signal:

Green LED: battery OK

Flashing green LED: low battery

No green LED: battery discharged

Overload signal:

red LED

Mechanical specifications

Operating temperature:

-10 °C to +55 °C, (maximum temperature for sensor is 90 °C)

Storage temperature:

-40 °C to +70 °C

Influence of temperature:

≤ 0.5 % of output signal per 10 °K

Relative humidity for operation:

0 to 95 % RH with a linear decrease above 35 °C

Influence of relative humidity:

< 0.2 % of output signal from 10 % to 85 % RH

Operating altitude:

0 to 2,000 m

Casing protection rating:

Casing: IP40 (IEC 529)

Flexible sensor: IP65 (IEC 529)

Drop test:

1 m (IEC 68-2-32)

Shock resistance:

100 g (IEC 68-2-27)

Vibration resistance (IEC 68-2-6):

5/15/5 1.5 mm

15/25/15 1 mm

25/55/25 0.25 mm

Self-extinguishing capability:

Casing, flexible sensor and click-lock

system: UL94 V0

Dimensions:

Casing: 140 x 64 x 28 mm (overall)

Connector lead: 2 m (connects sensor to casing)

Flexible sensor: Ø 12 mm ± 0.5 mm

Weight:

Casing: < 200 g

Flexible sensor: approx. 30 g per 10 cm length

Bending radius:

≥ 15 mm

Colours:

Casing and connection leads: dark grey, red flexible sensor with dark grey click-lock system

Output:

2 safety sockets (4 mm) spacing 19 mm

Safety specifications

Electrical safety:

Double insulation or reinforced insulation between primary, secondary and outer parts of casing liable to be handled, IEC 1010-1 - 1000 V category III, pollution degree 2

Electromagnetic compatibility (EMC):

EN 50081-1: compliant

EN 50082-2:

- Electrostatic discharge: IEC 1000-4-2

- Radiated field: IEC 1000-4-3

- Fast transients: IEC 1000-4-4

- Electrical shocks: IEC 1000-4-5

- Magnetic field at 50/60 Hz: IEC 1000-4-8

(1) Conditions of reference: 23 °C ± 5 °K, 20 % to 75 % RH, battery voltage: 9 V ± 0.5 V, external DC magnetic field < 40 A/m, no external magnetic or electrical field, conductor centred for measurement, sinusoidal signal: 10 ... 100 Hz.

To order	Reference
AmpFLEX™ 20-200/2, length 45 cm with operating manual	P01120503

flexible probe for AC current

odel A“ ” ”

AmpFLEX™ series

Current	2000 A AC
Output	1 mV/A

■ Electrical specifications

Current calibre:

0.5 A AC ... 2000 A AC

Output signal:

1 mVAC/A AC (2 V for 2000 A)

Accuracy ⁽¹⁾:

Primary current	0.5 A...5 A	5 A...2000 A
% Accuracy of output signal	not specified	≤ 1 %
Phase shift	≤ 0.7°	≤ 0.7°

Bandwidth:

10 Hz ... 20 kHz

Crest factor:

2.25 at rated current

Max. current / Max. output voltage:

No current limit, but maximum output is 4.5 V peak

Load impedance:

≥ 1 MΩ

Influence of Z load impedance:

≤ 0.1 %/Z, (Z in MΩ)

Output impedance:

1 kΩ

DC voltage shift at output:

≤ 2 mV DC

Operating voltage:

1000 V rms

Influence of adjacent conductor:

≤ 1 % interference current at 50 Hz
(≤ 2 % near click-lock system)

Influence of conductor position in loop:

≤ 1 % (≤ 4 % near click-lock system)

Influence of sensor shape:

≤ 1 % for an oblong shape

Battery:

9 V alkaline battery (NEDA 1604A, IEC 6LR61)

Battery life:

≥ 150 hrs continuous,
≥ 1000 x 1 minute measurements

Low battery signal:

Green LED: battery OK

Flashing green LED: low battery

No green LED: battery discharged

Overload signal:

red LED

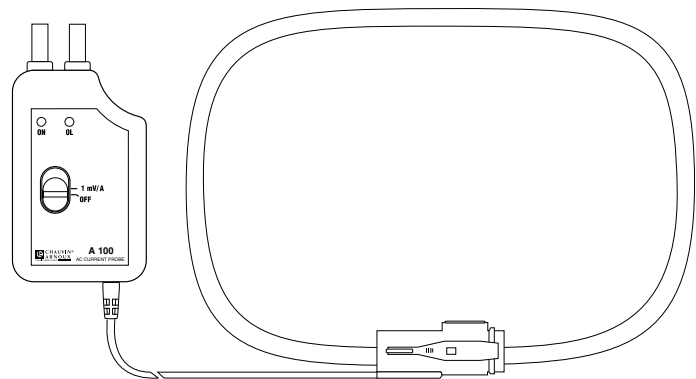

■ Mechanical specifications

Operating temperature:

-10 °C to +55 °C, (maximum temperature for sensor is 90 °C)

Storage temperature:

-40 °C to +70 °C

Influence of temperature:

≤ 0.5 % of output signal per 10 °K

Relative humidity for operation:

0 to 95 % RH with a linear decrease above 35 °C

Influence of relative humidity:

< 0.2 % of output signal from 10 % to 85 % RH

Operating altitude:

0 to 2,000 m

Casing protection rating:

Casing: IP40 (IEC 529)

Flexible sensor: IP65 (IEC 529)

Drop test:

1 m (IEC 68-2-32)

Shock resistance:

100 g (IEC 68-2-27)

Vibration resistance (IEC 68-2-6):

5/15/5 1.5 mm

15/25/15 1 mm

25/55/25 0.25 mm

Self-extinguishing capability:

Casing, flexible sensor and click-lock system:
UL94 V0

Dimensions:

Casing: 140 x 64 x 28 mm (overall)

Connector lead: 2 m (connects sensor to casing)

Flexible sensor: Ø 12 mm ± 0.5 mm

Weight:

Casing: < 200 g

Flexible sensor: approx. 30 g per 10 cm length

Bending radius:

≥ 15 mm

Colours:

Casing and connection leads: dark grey, red flexible sensor with dark grey click-lock system

Output:

2 safety sockets (4 mm) spacing 19 mm

■ Safety specifications

Electrical safety:

Double insulation or reinforced insulation between primary, secondary and outer parts of casing liable to be handled, IEC 1010-1- 1000 V category III, pollution degree 2

Electromagnetic compatibility (EMC):

EN 50081-1: compliant

EN 50082-2:

- Electrostatic discharge: IEC 1000-4-2

- Radiated field: IEC 1000-4-3

- Fast transients: IEC 1000-4-4

- Electrical shocks: IEC 1000-4-5

- Magnetic field at 50/60 Hz: IEC 1000-4-8

(1) Conditions of reference: 23 °C ± 5 °K, 20 to 75 % RH, battery voltage: 9 V ± 0.5 V, external DC magnetic field < 40 A/m, no external magnetic or electrical field, conductor centred for measurement, sinusoidal signal: 10 ... 100 Hz.

To order	Reference
AmpFLEX™ 2000/2, length 45 cm with operating manual	P01120501
AmpFLEX™ 2000/2, length 80 cm with operating manual	P01120502

flexible probe for AC current

odel A“ ” ” ”

AmpFLEX™ series

Current	200 A AC	2000 A AC
Output	10 mV/A	1 mV/A

Electrical specifications

Current calibres:
0.5 A AC ...200 A AC
0.5 A AC ...2000 A AC

Output signal:
10 mVAC/A AC (2 V for 200 A)
1 mVAC/A AC (2 V for 2000 A)

Accuracy (1):

Calibre	200 A		2000 A	
	Primary current	0.5 A...5 A	5 A...200 A	0.5 A...5 A
% Accuracy of output signal	not specified	≤ 1 %	not specified	≤ 1 %
Phase shift	≤ 0.7°	≤ 0.7°	≤ 0.7°	≤ 0.7°

Bandwidth:
10 Hz ...20 kHz

Crest factor:
2.25 at rated current

Max. current/Max. output voltage:
No current limit, but maximum output is 4.5 V peak

Load impedance:
≥ 1 MΩ

Influence of Z load impedance:
≤ 0.1 %/Z, (Z in MΩ)

Output impedance:
1 kΩ

DC voltage shift at output:
■ 200 A calibre: ≤ 5 mV DC
■ 2000 A calibre: ≤ 2 mV DC

Operating voltage:
1000 V rms

Influence of adjacent conductor:
≤ 1 % interference current at 50 Hz
(≤ 2 % near click-lock system)

Influence of conductor position in loop:
≤ 1 % (≤ 4 % near click-lock system)

Influence of sensor shape:
≤ 1 % for an oblong shape

Battery:
9 V alkaline battery (NEDA 1604A, IEC 6LR61)

Battery life:
≥ 150 hrs continuous,
≥ 1000 x 1 minute measurements

Low battery signal:
Green LED: battery OK
Flashing green LED: low battery
No green LED: battery discharged

Overload signal:
Red LED

Mechanical specifications

Operating temperature:
-10 °C to +55 °C, (maximum temperature for sensor is 90 °C)

Storage temperature:
-40 °C to +70 °C

Influence of temperature:
≤ 0.5 % of output signal per 10 °K

Relative humidity for operation:
0 to 95 % RH with a linear decrease above 35 °C

Influence of relative humidity:
< 0.2 % of output signal from 10 % to 85 % RH

Operating altitude:
0 to 2,000 m

Casing protection rating:
Casing: IP40 (IEC 529)
Flexible sensor: IP65 (IEC 529)

Drop test:
1 m (IEC 68-2-32)

Shock resistance:
100 g (IEC 68-2-27)

Vibration resistance (IEC 68-2-6):
5/15/5 1.5 mm
15/25/15 1 mm
25/55/25 0.25 mm

Self-extinguishing capability:
Casing, flexible sensor and click-lock system:
UL94 V0

Dimensions:
Casing: 140 x 64 x 28 mm (overall)
Connector lead: 2 m (connects sensor to casing)
Flexible sensor: Ø 12 mm ± 0.5 mm

Weight:

Casing: < 200 g
Flexible sensor: approx. 30 g per 10 cm length

Bending radius:
≥ 15 mm

Colours:
Casing and connection leads: dark grey, red flexible sensor with dark grey click-lock system

Output:
2 safety sockets (4 mm) spacing 19 mm

Safety specifications

Electrical safety:
Double insulation or reinforced insulation between primary, secondary and outer parts of casing liable to be handled, IEC 1010-1- 1000 V category III, pollution degree 2

Electromagnetic compatibility (EMC):
EN 50081-1: compliant
EN 50082-2:
- Electrostatic discharge: IEC 1000-4-2
- Radiated field: IEC 1000-4-3
- Fast transients: IEC 1000-4-4
- Electrical shocks: IEC 1000-4-5
- Magnetic field at 50/60 Hz: IEC 1000-4-8

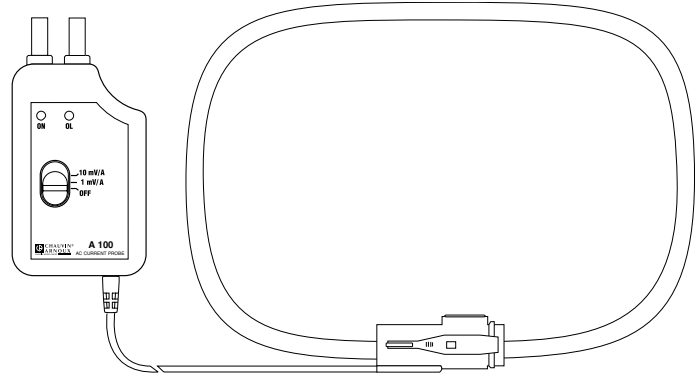

(1) Conditions of reference: 23 °C ± 5 °K, 20 % to 75 % RH, battery voltage: 9 V ± 0.5 V, external DC magnetic field < 40 A/m, no external magnetic or electrical field, conductor centred for measurement, sinusoidal signal: 10...100 Hz.

To order	Reference
AmpFLEX™ 200-2000/2, length 45 cm with operating manual	P01120504
AmpFLEX™ 200-2000/2, length 80 cm with operating manual	P01120505

flexible probe for AC current model A⁴

AmpFLEX™ series

Current	300 AAC	3000 AAC
Output	10 mV/A	1 mV/A

Electrical specifications

Current calibres:
0.5 A AC ... 300 A AC
0.5 A AC ... 3000 A AC

Output signal:
10 mVAC/A AC (3 V for 300 A)
1 mVAC/A AC (3 V for 3000 A)

Accuracy ⁽¹⁾:

Calibre	300 A		3000 A	
	Primary current	0.5 A...5 A	5 A...300 A	0.5 A...5 A
% Accuracy of output signal	not specified	≤ 1 %	not specified	≤ 1 %
Phase shift	≤ 0.7°	≤ 0.7°	≤ 0.7°	≤ 0.7°

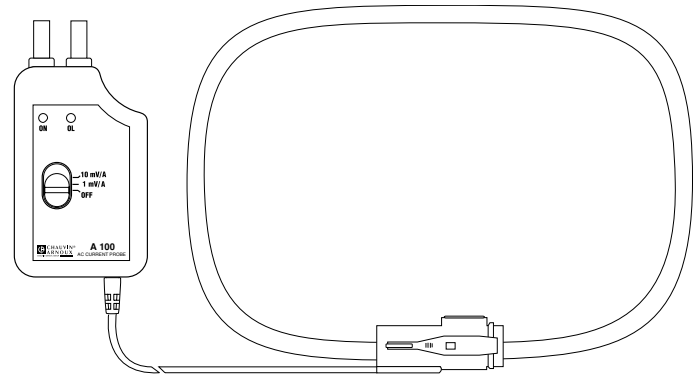

Bandwidth:

10 Hz ... 20 kHz

Crest factor:

1.5 at rated current

Max. current / Max. output voltage:

No current limit, but maximum output is 4.5 V peak

Load impedance:

≥ 1 MΩ

Influence of Z load impedance:

≤ 0.1 % / Z, (Z in MΩ)

Output impedance:

1 kΩ

DC voltage shift at output:

- 300 A calibre: ≤ 5 mV DC
- 3000 A calibre: ≤ 2 mV DC

Operating voltage:

1000 V rms

Common mode voltage:

600 V category III and pollution degree 2

Influence of adjacent conductor:

≤ 1 % interference current at 50 Hz
(≤ 2 % near click-lock system)

Influence of conductor position in loop:

≤ 1 % (≤ 4 % near click-lock system)

Influence of sensor shape:

≤ 1 % for an oblong shape

Battery:

9 V alkaline battery (NEDA 1604A, IEC 6LR61)

Battery life:

≥ 150 hrs continuous,
≥ 1000 x 1 minute measurements

Low battery signal:

Green LED: battery OK

Flashing green LED: low battery

No green LED: battery discharged

Overload signal:

Red LED

Mechanical specifications

Operating temperature:

-10 °C to +55 °C, (maximum temperature for sensor is 90 °C)

Storage temperature:

-40 °C to +70 °C

Influence of temperature:

≤ 0.5 % of output signal per 10 °K

Relative humidity for operation:

0 to 95 % RH with a linear decrease above 35 °C

Influence of relative humidity:

< 0.2 % of output signal from 10 % to 85 % RH

Operating altitude:

0 to 2,000 m

Casing protection rating:

Casing: IP40 (IEC 529)
Flexible sensor: IP65 (IEC 529)

Drop test:

1 m (IEC 68-2-32)

Shock resistance:

100 g (IEC 68-2-27)

Vibration resistance:

5/15/5 1.5 mm
15/25/15 1 mm
25/55/25 0.25 mm
(IEC 68-2-6)

Self-extinguishing capability:

Casing, flexible sensor and click-lock system:
UL94 V0

Dimensions:

Casing: 140 x 64 x 28 mm (overall)

Connector lead: 2 m (connects sensor to casing)

Flexible sensor: Ø 12 mm ±0,5 mm

Weight:

Casing: < 200 g

Flexible sensor: 30 g per 10 cm length

Bending radius:

≥ 15 mm

Colours:

Case and connection leads: dark grey, red
flexible sensor with dark grey click-lock system

Output:

2 safety sockets (4 mm) spacing 19 mm

Safety specifications

Electrical safety:

Double insulation or reinforced insulation between primary, secondary and outer parts of casing liable to be handled, IEC 1010-1-1000 V category III, pollution degree 2

Electromagnetic compatibility (EMC):

EN 50081-1: compliant

EN 50082-2:

- Electrostatic discharge: IEC 1000-4-2
- Radiated field: IEC 1000-4-3
- Fast transients: IEC 1000-4-4
- Electrical shocks: IEC 1000-4-5
- Magnetic field at 50/60 Hz: IEC 1000-4-8

(1) Conditions of reference: 23 °C ± 5 °K, 20 % to 75 % RH, battery voltage: 9 V ± 0.5 V, external DC magnetic field < 40 A/m, no external magnetic or electrical field, conductor centred for measurement, sinusoidal signal: 10 ... 100 Hz.

To order	Reference
AmpFLEX™ 300-3000/3, length 45 cm with operating manual	P01120506
AmpFLEX™ 300-3000/3, length 80 cm with operating manual	P01120507
AmpFLEX™ 300-3000/3, length 120 cm with operating manual	P01120508

flexible probe for AC current

odel A“ “ “ “

AmpFLEX™ series

Current	1000 AAC	10000 AAC
Output	1 mV/A	0.1 mV/A

Electrical specifications

Current calibres:

0.5 A AC ... 1000 A AC
0.5 A AC ... 10000 A AC

Output signal:

1 mVAC/A AC (1 V for 1000 A)
0.1 mVAC/A AC (1 V for 10000 A)

Accuracy ⁽¹⁾:

Calibre	1000 A		10000 A	
	0.5 A...5 A	5 A...1000 A	0.5 A...50 A	0.5 A...10000 A
Primary current				
% Accuracy of output signal	not specified	≤ 1 %	not specified	≤ 1 %
Phase shift	≤ 0.5°	≤ 0.5°	≤ 0.5°	≤ 0.5°

Bandwidth:

10 Hz ... [45 ... 65] ... 20 kHz

Crest factor:

4.5 at rated current

Max. current / Max. output voltage:

No current limit, but maximum output is 4.5 V peak.

Load impedance:

≥ 1 MΩ

Influence of Z load impedance:

≤ 0.1 %/Z, (Z in MΩ)

Output impedance:

1 kΩ

DC voltage shift at output:

- 1000 A calibre: ≤ 2 mV DC
- 10000 A calibre: ≤ 1 mV DC

Operating voltage: 1000 Vrms

Influence of adjacent conductor:

≤ 1 % interference current at 50 Hz
(≤ 2 % near click-lock system)

Influence of conductor position in loop:

≤ 1 % (≤ 4 % near click-lock system)

Influence of sensor shape:

≤ 1 % for an oblong shape

Battery:

9 V alkaline battery (NEDA 1604A, IEC 6LR61)

Battery life:

≥ 150 hrs continuous,
≥ 1000 x 1 minute measurements

Low battery signal:

Green LED: battery OK
Flashing green LED: low battery
No green LED: battery discharged

Overload signal:

Red LED

Mechanical specifications

Operating temperature:

-10 °C to +55 °C, (maximum temperature for sensor is 90 °C)

Storage temperature:

-40 °C to +70 °C

Influence of temperature:

≤ 0.5 % of output signal per 10 °K

Relative humidity for operation:

0 to 95 % RH with a linear decrease above 35 °C

Influence of relative humidity:

< 0.2 % of output signal from 10 % to 85 % RH

Operating altitude:

0 to 2,000 m

Casing protection rating:

Casing: IP40 (IEC 529)
Flexible sensor: IP65 (IEC 529)

Drop test: 1 m (IEC 68-2-32)

Shock resistance:

100 g (IEC 68-2-27)

Vibration resistance:

5/15/5 1.5 mm
15/25/15 1 mm
25/55/25 0.25 mm
(IEC 68-2-6)

Self-extinguishing capability:

Casing, flexible sensor and click-lock system:
UL94 V0

Dimensions:

Casing: 140 x 64 x 28 mm (overall)
Connector lead: 2 m (connects sensor to casing)
Flexible sensor: Ø 12 mm ± 0.5 mm

Weight:

- Casing: < 200 g
- Flexible sensor: approx. 30 g per 10 cm length

Bending radius:

≥ 15 mm

Colours:

Casing and connection leads: dark grey,
red flexible sensor with dark grey click-lock system

Output:

2 safety sockets (4 mm) spacing 19 mm

Safety specifications

Electrical safety:

Double insulation or reinforced insulation between primary, secondary and outer parts of casing liable to be handled, IEC 1010-1- 1000 V category III, pollution degree 2

Electromagnetic compatibility (EMC):

- EN 50081-1: compliant
- EN 50082-2:
 - Electrostatic discharge: IEC 1000-4-2
 - Radiated field: IEC 1000-4-3
 - Fast transients: IEC 1000-4-4
 - Electrical shocks: IEC 1000-4-5
 - Magnetic field at 50/60 Hz: IEC 1000-4-8

(1) Conditions of reference: 23 °C ± 5 °K, 20 % to 75 % RH, battery voltage: 9 V ± 0.5 V, external DC magnetic field < 40 A/m, no external magnetic or electrical field, conductor centred for measurement, sinusoidal signal: 10 ... 100 Hz.

To order	Reference
AmpFLEX™ 1000-10000/1, length 120 cm with operating manual	P01120509

flexible probe for AC current model A100 on request

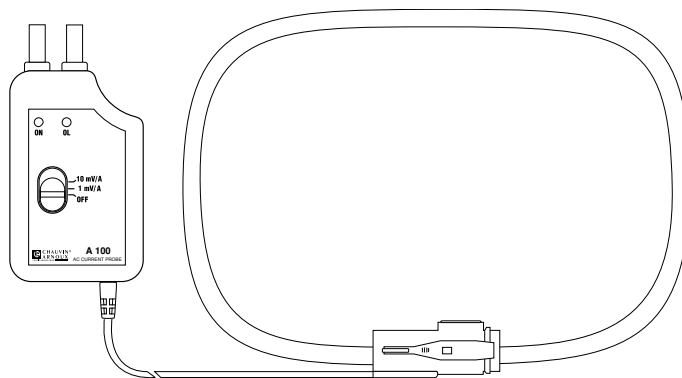

To complete the comprehensive range of standard models presented on the preceding pages, Chauvin Arnoux also offers to make special models to meet your particular needs.

In this way it is possible to define AmpFLEX™ flexible current sensors with sensitivities and lengths corresponding to your applications.

To do so, it is necessary to give a reference as follows:

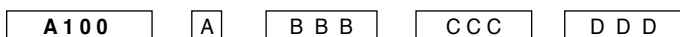

with:

A : Number of ranges

BBB : Max. range value, in Amperes

CCC : Max. range sensitivity in mV/A

DDD : Length of flexible sensor in cm (min X 40 = 40 cm, max = 990 cm) for a section of 10 cm

Currently available values:

Model	A 1 0 0	A	B B B	C C C	D D D
20-200 A/2 V	A 1 0 0	2	2 0 0	X 1 0	
2000 A/2 V	A 1 0 0	1	2 K 0	X X 1	
200-2000 A/2 V	A 1 0 0	2	2 K 0	X X 1	
300-3000 A/3 V	A 1 0 0	2	3 K 0	X X 1	
1000-10000 A/1 V	A 1 0 0	2	1 0 K	0 . 1	

Example 1:

An AmpFLEX™ A100 flexible sensor, with 2 ranges 200-2000 A and length 5 m would be represented by:

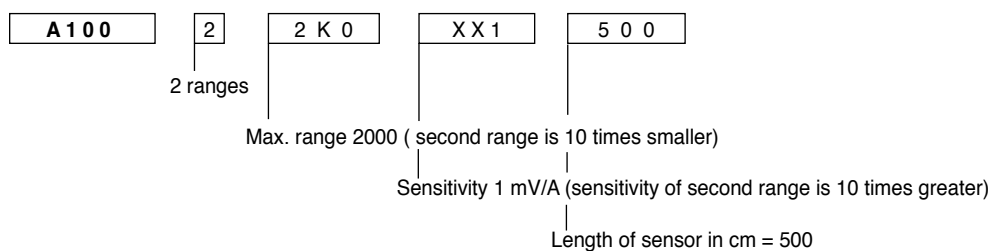

Example 2:

An AmpFLEX™ flexible sensor, range 2000 A, length 90 cm would be represented by:

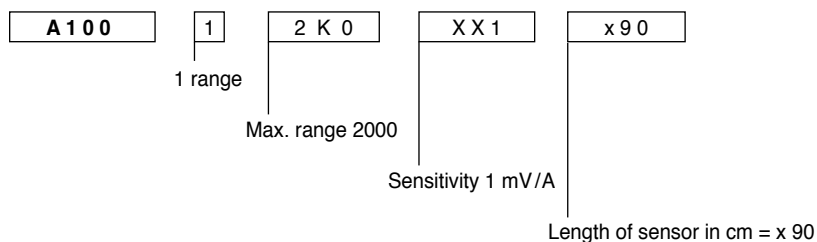

As Chauvin Arnoux is always seeking to improve its products, do not hesitate to contact us for other configurations.

flexible probe for AC current model A“ “

AmpFLEX™ series

⚠ CAUTION

These products are only offered under certain conditions (quantity, etc.) to manufacturers of measurement, location and detection instruments.

The AmpFLEX™ offers perfect linearity, low phase shift, a wide range of measurements (up to several kA) and unrivalled ease of use. The A101 series is Chauvin Arnoux's response to all the measurement instrument manufacturers wishing to integrate AmpFLEX™ solutions into their product lines.

■ Description

The A101 AmpFLEX™ sensor is composed of an active element (Rogowski coil) and a connection lead. It is necessary to add on an electronic processing system (not included), in order to complete this measurement device.

Chauvin Arnoux has added an extra step to the manufacturing process of the A101 probe which guarantees their interchangeability. This is essential in applications such as three-phase measurements where several identical probes are used.

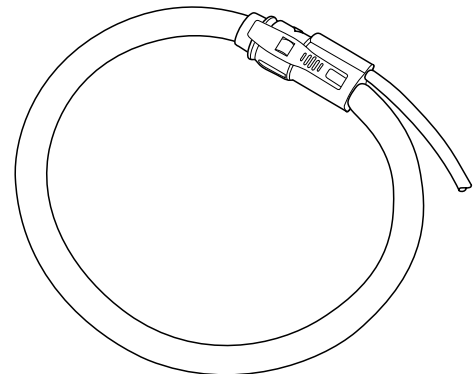

■ Electrical specifications

Voltage at sensor terminals:

46 $\mu\text{V}/\text{A}$ (-15 % ... +10 %) at 50 Hz

Linearity*:

< 0.3 %

Phase shift*:

$\leq 0.5^\circ$ at 50 Hz

Interchangeability error:

≤ 0.5 % (maximum error between 2 sensors for the same measurement point).

Frequency range:

Depends on the electronics with which it is used.

Operating voltage:

1000 V rms or DC

■ Mechanical specifications

Operating temperature:

-20 °C to +60 °C

Storage temperature:

-0 °C to + 80 °C

Max temperature of measured cable:

≤ 90 °C

Operating altitude:

0 to 2,000 m

Maximum conductor size:

Depending on sensor length.

Casing protection rating:

IP65 in accordance with EN 60529

Self-extinguishing capability:

External cover, click-lock system, connection lead: UL94 V0

Dimensions:

\varnothing of sensor: 12 mm

Weight:

Approx. 30 g per 10 cm length

Colour:

Sensor: red

Click-lock system: dark grey

Output:

According to configuration (refer to § Connections)

Connexions:

According to configuration (refer to § Connections)

■ Safety specifications

Electrical safety:

Double insulation or reinforced insulation between primary, secondary and outer parts of casing liable to be handled, IEC 1010-1 & IEC 1010-2-032, 1000 V category III, pollution degree 2

Electromagnetic compatibility (EMC):

EN 50081-1: class B

EN 50082-2:

- Electrostatic discharge: IEC 61000-4-2

- Radiated field: IEC 61000-4-3

- Fast transients: IEC 61000-4-4

- Magnetic field at 50/60 Hz: IEC 61000-4-8

* Conditions of reference: 23 °C \pm 6 K, 20 % to 75 % RH, frequency 10 Hz to 100 Hz, sinusoidal signal, no external AC magnetic field, external magnetic field ≤ 40 A/m (earth field), conductor centred for measurement.

flexible probe for AC current odel A“ “

AmpFLEX™ series

■ Configurations

Level 1

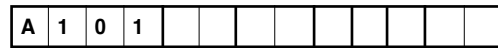

Category (fixed field)

Lead length in decimetres

Min value: **05** (50 cm)

Max value: **99** (9.9 m)

Increment per 1 dm section (10 cm)

Length of connection lead in decimetres

Min value: **05** (50 cm)

Max value: **99** (9.9 m)

Increment per section of 1 dm (10 cm)

Measurement range (refer to additional information)

0: without

2: electronic diagram CA2

1: electronic diagram CA1

3: electronic diagram CA3

or C.A 833X and C.A 823X

4: diagram suited for C.A 8310

Connections

X: lead without connection unit

C: specific lead

Calibration for interchangeability (refer to additional information)

N: without

O: with

Special feature

X1: plain sensor without CHAUVIN ARNOUX logo, with standard and AmpFLEX™ inscriptions, plain packing with instruction manual

X2: plain sensor without CHAUVIN ARNOUX logo, with standard and AmpFLEX™ inscriptions, plastic bag packing, instruction manual stapled on the plastic bag

C1: same as CHAUVIN ARNOUX sensor plain packing box with instruction manual

C2: same as CHAUVIN ARNOUX sensor plastic bag packing, instruction manual stapled on the plastic bag

Level 2



Connections (refer to additional information)

XXX1: circular lead 2 conductors + bare and tinned

BNC1: coaxial lead + insulated coaxial plug

FRB1: circular lead 2 conductors + screening with FRB connector
D01 model, type 1 (male pins)

FRB2: circular lead 2 conductors + screening with FRB connector
D01 model, type 2 (sockets)

833X: specific connections for Qualistar C.A 833X and C.A 823X

Colour of connector (refer to additional information)

XX: no connector

GN: green

BK: black

WH: white

RD: red

YE: yellow

BU: blue

+ connection point

1, 2 or 3: contact N° connected to +

X: no connector

-: for 833X and 823X connection: not concerned

- connection point

1, 2 or 3: contact N° connected to -

X: no connector

-: for 833X and 823X connection: not concerned

Connected protection

1, 2 or 3: contact N° connected to screening

X: not connected or no connector

-: for 833X and 823X connection: not concerned

Interchangeability resistors (refer to additional information)

I: included in sensor

F: resistors supplied

D: values are indicated in the manual included with AmpFLEX™ (resistors not supplied)

X: no calibration for interchangeability

Specific configuration of sensors for C.A 8310 Power & Harmonics Analyser

To complete the range of standard sensors for this product, A190 sensors of different lengths can be used (the A190 is simply a specific type of A101).

Select:

Level 1	A	1	0	1					4	C	O	C	1
Level 2	F	R	B	1					1	3	X	I	

Blank spaces refer to:

- level 1: sensor lengths and connection lead to be chosen
- level 2: colour of connector

Additional information

Measurement range (electronic diagram)

Choosing the measurement range depends on the sensitivity required and on electronic supply voltages.

Example:

For a supply voltage of ± 5 V, electronic output voltage will be limited to ± 4.5 V peak to peak, that is to say approximately 3 V RMS ($4.5 \text{ V} / \sqrt{2}$) if measured signal is sinusoidal.

The different diagrams refer to sensitivity ranges in accordance with the following chart:

Diagram	CA1	CA2	CA3
Sensitivity	0.1 mV/A...1 mV/A	1 mV/A...10 mV/A	10 mV/A...100 mV/A
Max. measurement range for a ± 5 V supply	3000 A...30000 A	300 A...3000 A	30 A...300 A
Max. measurement range for a ± 15 V supply	9000 A...90000 A	900 A...9000 A	90 A...900 A

Interchangeability calibration

For applications that require the use of several sensors, it is necessary to ensure that all the sensors used on a single measuring instrument have identical output specifications.

Calibration is carried out for a standard electronic circuit (refer to following chart) at input level (integrator).

Associated electronics

This uses the standard diagrams of the input stage, corresponding to the different measurement ranges required.

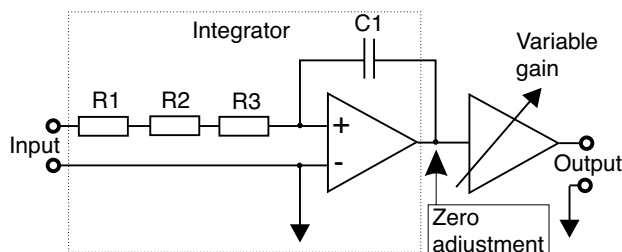

Values of integrator's resistors and capacitor according to sensitivity.

Diagram	CA1	CA2	CA3
Sensitivity	0.1 mV/A...1 mV/A	1 mV/A...10 mV/A	10 mV/A...100 mV/A
C1	100 nF	10 nF	1 nF
R1 = R2 = R3	4.12 kΩ		

C1 preferably in polycarbonate (tolerance 5 %).



R1, R2 and R3 metallic coating, tolerance 1 %, power 1/8 W temperature coefficient 50 ppm.

Standard technology or SMD.

flexible probe for AC current odel A“ “

AmpFLEX™ series

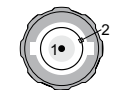
Connection

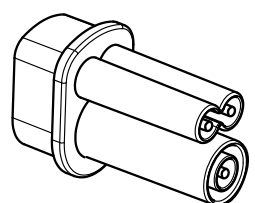
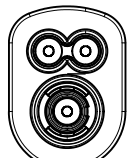
Connector	Choice of connections	Colour of the connector
BNC1 Coaxial leads + insulated coaxial plug 		BK: black RD: red ⁽¹⁾ BU: blue ⁽¹⁾
FRB1: FRB D01 model Contact: male FRB2: FRB D01 model Contact: female 		BK: black RD: red BU: blue GN: green ⁽¹⁾ WH: white YE: yellow ⁽¹⁾
Connection for C.A 833x models: IEC 61010 		BK: black RD: red BU: blue GN: green YE: yellow

(1) colour not in stock

Interchangeability resistors

In order to enable interchangeability of sensors, the calibration process involves defining the value of a resistor which will be inserted in the measurement circuit.

In fact, these resistors can be integrated into connectors FRB1 or FRB2.

Contact us for details of other types of connectors.

To order	Reference
A101 AmpFLEX without electronic unit Accessories:	Contact us
"Green" click-on adapters (set of 10)	P01101921
"Red" click-on adapters (set of 10)	P01101922
"Purple" click-on adapters (set of 10)	P01101923
"Black" click-on adapters (set of 10)	P01101924
"Blue" click-on adapters (set of 10)	P01101925
"Yellow" click-on adapters (set of 10)	P01101926
"Brown" click-on adapters (set of 10)	P01101927
"White" click-on adapters (set of 10)	P01101928
"Grey" click-on adapters (set of 10)	P01101929
9 assorted colours (9 sets of 2)	P01101930
Coloured click-on adapters C.A 8310 ("blue", "red", "black" set of 2)	P01101931



K series

The K series is a new product range with exceptional measurement capabilities.

Extremely compact in design, these “micro-probes” are designed for highly accurate measurement of very low currents.

Their small dimensions and shape make them ideal for probing into tight spaces where access is limited, as is the case on most switchboards, 4-20 A process loops or vehicle wiring looms for example.

These “K” series current probes make excellent work companions for multimeters and any other instrument able to make use of their high sensitivity, dynamic range and ability to indicate the shapes of signals and waveforms.

They give an AC+DC output signal that is proportional to the measured current, without needing to change the range or filter the signal. RMS measurements are possible with DC+AC components.

There are two different types of K series current probes available.

Model K1 gives a 1 mV/mA output and lends itself to a variety of different applications, oriented towards low-current measurement.

Model K2 has a greater level of sensitivity with its 10 mV/mA output.

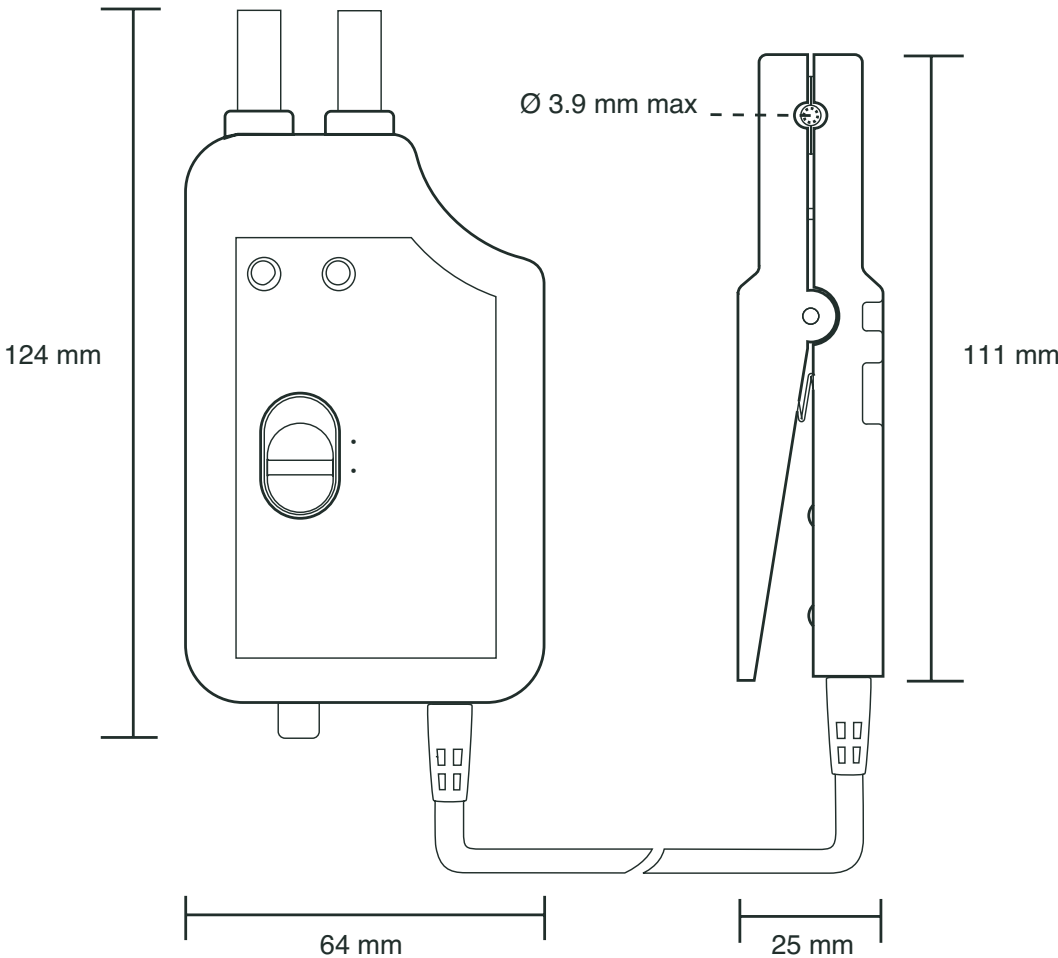

AC dC current probe odel “

K series

Current	4500 mA DC 3000 mA AC
Output	1 mV/mA

■ Description

The K1 model measures currents as low as 100 µA AC or DC.
The clamp provides a proportional output signal enabling direct readings on multimeters.

■ Electrical specifications

Current calibres:
1 mA DC...± 4.5 A DC
1 mA rms...3 A rms (sinusoidal)
1 mA...4.5 A peak, square and steps
Output (output voltage): 1 mV/mA

Resolution:
DC: 50 µA typical
AC: 100 µA typical

Accuracy ⁽¹⁾:

DC current

Primary current	1 mA...10 mA	10 mA...120 mA	120 mA...4500 mA
Accuracy in % of output signal	2 % ± 0.2 mV	2 % ± 0.1 mV	1 %

AC current from 45 Hz to 65 Hz

Primary current	1 mA...10 mA	10 mA...120 mA	120 mA...3000 mA
Accuracy in % of output signal	3 % ± 0.3 mV	3 % ± 0.1 mV	1 %

Frequency response:

DC to 2kHz (to -3 dB)

Load impedance:

≥ 1 MΩ and ≤ 100 pF

Output noise:

< 100 µV, DC to 3 kHz

Output impedance:

220 Ω

Inductance of clamp:

< 1 µH

Rise time:

< 200 µs, 10 % to 90 %

Fall time:

< 200 µs, 90 % to 10 %

Influence of adjacent conductors

(50 Hz at 23 mm from the clamp):

< 100 µA/A

Influence of earth field:

< 120 µA

Battery:

Alkaline 9 V, NEDA 1604,
6LR61 or IEC 6 LF22

Battery level indication:

Green LED when battery voltage > 6.5 V

Battery charge life:

Approximately 20 hours

Overload indication:

Red LED indicating momentary or continuous overload

Max. current:

200 A AC or DC with current limitation according to with frequency, above 400 Hz

■ Mechanical specifications

Operating temperature:

-10 °C to +55 °C

Storage temperature:

-40 °C to +80 °C

Influence of temperature:

< 1000 ppm/°K or 1 %/10 °C

Humidity:

< 95 % for < 35 °C, 75 % at +55 °C

Operating altitude:

0 to 2,000 m

Adjustment of DC zero:

approximately ±25 mA by turning the button on the bottom of the housing

Max. jaw insertion capacity:

Ø 3.9 mm

Protection rating:

IP 40 in accordance with IEC 529

Drop test:

1.0 m in accordance with IEC 68-2-32

Impacts:

100 g in accordance with IEC 68-2-27

Vibration:

in accordance with IEC 68-2-6

Frequency range:

5 to 15 Hz, amplitude: 1.5 mm

15 to 25 Hz: amplitude: 1 mm

25 to 55 Hz: amplitude: 0.25 mm

Dimensions:

Electronic module: 124 x 64 x 28 mm

Probe: 111 x 15 x 25 mm

Cable length:

1.5 m

Weight:

250 g

Colour:

Dark grey

Output:

Two 4 mm safety terminals 19 mm apart.

■ Safety specifications

Operating voltage:

300 V in accordance with IEC 1010-1 Cat. II

Electromagnetic compatibility:

Immunity (EN 50082-1): class A

DC: 15 mV for 0

AC (60 Hz): 2 dB from 10 mA...4.5 A

Emissivity (EN 50081-1): negligible

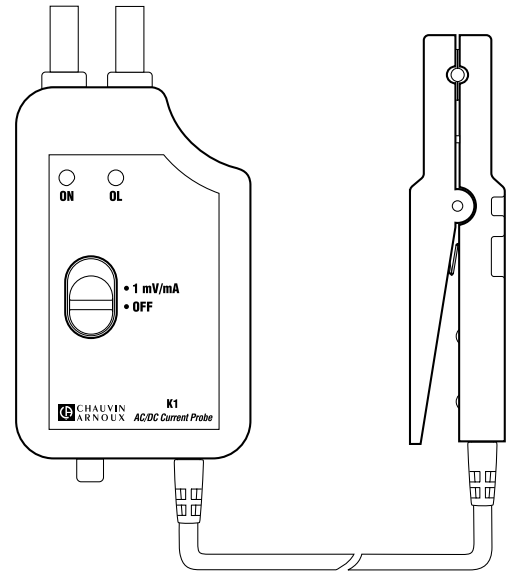

(1) Conditions of reference: 23 °C ± 3 °C, 20 % to 75 % RH, batteries 9 V ± 0.1 V, earth's magnetic field < 40 A/m, no AC field, DC or sinusoidal current from 45 Hz to 65 Hz

To order	Reference
AC/DC current clamp model K1 in carrying case with battery and user's manual	P01120067A

Current	450 mA DC 300 mA AC
Output	10 mV/mA

■ Description

The K2 model measures currents as low as 100 µA AC or DC.
The probe has a proportional output for direct readings on multimeters.

■ Electrical specifications

Current calibres:

0.1 mA DC...± 450 mA DC
0.1 mA rms...300 mA rms (sinusoidal)
0.1 mA peak...450 mA peak, square signal and steps

Output (output voltage):

10 mV/mA

Resolution:

DC: 50 µA typical
AC: 100 µA typical

Accuracy ⁽¹⁾:

DC current

Primary current	0.1 mA...1 mA	1 mA...12 mA	12 mA...450 mA
Accuracy in % of output signal	3 % ± 2 mV	2 % ± 2 mV	1 %

AC current from 45 Hz to 65 Hz

Primary current	0.1 mA...1 mA	1 mA...12 mA	12 mA...300 mA
Accuracy in % of output signal	3 % ± 0.5 mV	2 % ± 0.5 mV	1 %

Frequency response:

DC to 1.5 kHz (to -3 dB)

Load impedance:

≥ 1 MΩ and ≤ 100 pF

Output noise:

< 100 µV DC to 1.5 kHz

Output impedance:

200 Ω

Inductance of clamp:

< 1 µH

Rise time:

< 200 µs, 10 % to 90 %

Fall time:

< 200 µs, 90 % to 10 %

Influence of adjacent conductors:

(50 Hz at 23 mm from the clamp):
< 100 µA /A

Influence of earth field:

< 120 µA, 0...max

Battery:

Alkaline 9 V, NEDA 1604, 6LR61
or IEC 6 LF22

Battery level indication:

Green LED when battery voltage > 6.5 V

Battery charge life:

Approximately 20 hours

Overload indication:

Red LED indicating momentary or continuous overload

Max. current:

100 A AC rms or DC with current limitation
according to with frequency, above 800 Hz

■ Mechanical specifications

Operating temperature:

-10 °C to +55 °C

Storage temperature:

-40 °C to +80 °C

Influence of temperature:

< 500 ppm/°K or 0.5 % / 10 °C

Humidity:

< 95 % at < 35 °C, 75 % at 55 °C

Operating altitude:

0 to 2,000 m

Adjustment of DC zero:

approximately ±15 mA by turning the button
on the bottom of the housing (10 turns)

Max. jaw insertion capacity:

Ø 3.9 mm

Protection rating:

IP40 in accordance with IEC 529

Drop test:

1.0 m in accordance with IEC 68-2-32

Impacts:

100 g in accordance with IEC 68-2-27

Vibration:

in accordance with IEC 68-2-6

Frequency range:

5 Hz...15 Hz, amplitude: 1.5 mm
15 Hz...25 Hz: amplitude: 1 mm
25 Hz...55 Hz: amplitude: 0.25 mm

Dimensions (electronic module):

124 x 64 x 28 mm

Dimension (probe):

111 x 15 x 25 mm

Cable length:

1.5 m

Weight:

250 g

Colour:

Dark grey

Output:

Two 4 mm safety terminals 19 mm apart.
(standard)

■ Safety specifications

Operating voltage:

300 V in accordance with IEC 1010-1 Cat. II

Electromagnetic compatibility:

Immunity (EN 50082-1): class A
DC: 15 mV for 0
AC (60 Hz): 2 dB from 10 mA...4.5 A
Emissivity (EN 50081-1): negligible

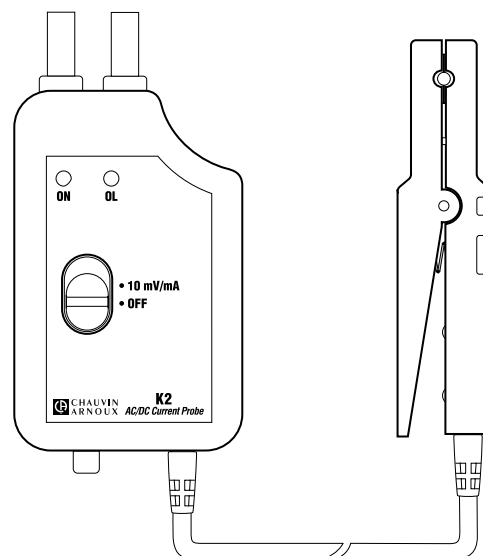

(1) Conditions of reference: 23 °C ± 3 °C, 20 °C to 75 % RH, batteries 9 V ± 0.1 V, earth's magnetic field < 40 A/m, no AC field, DC or sinusoidal current from 45 Hz to 65 Hz

To order	Reference
AC/DC current clamp model K2 in carrying case with battery and user's manual	P01120074A



E_N series

The E_N series clamps use Hall-effect technology for the measurement of AC and DC currents from several milliamps to over 100 A.

These clamps' narrow, elongated design makes them ideal for measurements in cable bundles or in other confined areas like circuit boards, motor controls or motor vehicle electrical circuits.

Their low phase shifting also ensures excellent performance for power measurements.

These clamps have a voltage output (mv) and their ability to measure AC and DC signals is useful for true RMS measurements.

Model E6N is the most sensitive for low current measurements.

The E series clamps all make excellent work mates for multimeters, recorders and logging equipment, etc. Model E3N can even be connected directly to an oscilloscope.

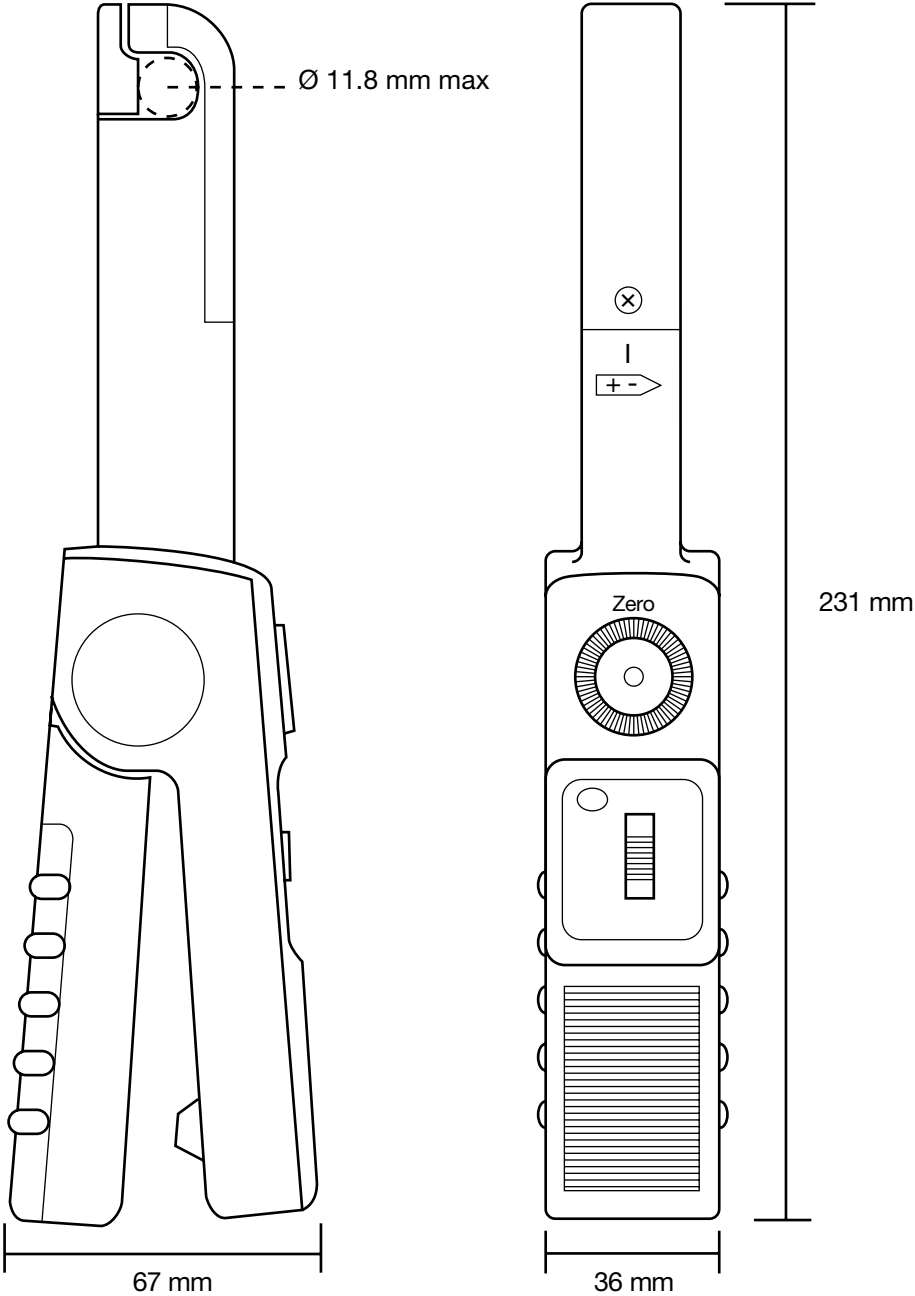

AC dC current clamp odel "n

EN series

Current	2 A AC/DC	150 A AC/DC
Output	1 mV/mA	1 mV/A

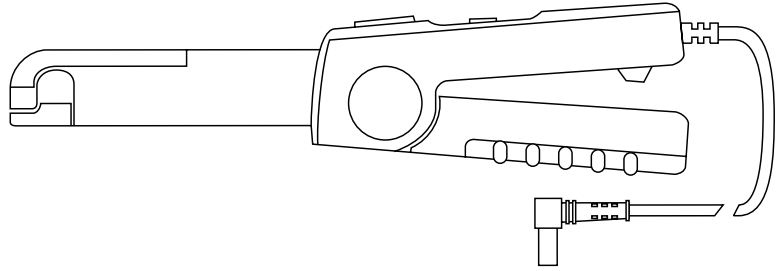

Electrical specifications

Current range:

50 mA...150 A AC/DC over two calibres

Output signal:

1 mV/mA and 1 mV/A AC or DC

Accuracy and phase shift ⁽¹⁾:

Calibre	1 mV/mA (1 V/A)	1 mV/A
Current range	50 mA...2 A DC 50 mA...1.5 AAC	500 mA...150 A
Accuracy in % of output signal	2% ± 20 mV	500 mA...100 A AC/DC: 1.5% ± 30 µV 100 A...150 A DC: 3% 100 A...120 A AC: 3%
Frequency range	DC...65 Hz: 3°	DC...65 Hz: 1°
Phase shift	not specified	not specified
Min load impedance	≥ 10 kΩ	≥ 2 kΩ
Noise	DC...1 Hz: 3 mV 1 Hz...10 kHz: 10 mV 10 kHz...100 kHz: 18 mV	DC...1 Hz: 3 µV 1 Hz...10 kHz: 10 µV 10 kHz...100 kHz: 18 µV

Operating voltage:

600 V rms max

Common mode voltage:

600 V rms max

Battery:

9 V alkaline (NEDA 1604A, IEC 6LR61)

Battery life:

70 hours typical

Typical consumption:

6 mA

Battery level indicator:

Green LED when > 6.5 V

Mechanical specifications

Operating temperature:

0° to +50 °C

Storage temperature:

-30 °C to +80 °C

Influence of temperature:

< 0.2 % per °C

Relative humidity for operation:

+10 °C to +30 °C:

85 ± 5 % RH (without condensation)

+40 °C to +50 °C:

45 ± 5 % RH (without condensation)

Operating altitude:

0 to 2,000 m

Max. jaw insertion capacity:

11.8 mm

Zero adjustment:

20 turn potentiometer (± 1.5 A min)

Drop test:

1 m on a 38 mm container of oak on concrete, test in accordance with IEC 1010

Shock resistance:

100 g, in accordance with IEC 68-2-27

Vibration resistance:

10/55/10 Hz, 0.15 mm
test in accordance with IEC 68-2-6

Casing protection rating:

IP20 in accordance with IEC 529

Self-extinguishing capability:

Casing: UL94 V2

Dimensions:

231 x 36 x 67 mm

Weight:

330 g with batteries

Colour:

Dark grey

Output:

1.5 m two-wire lead with double or reinforced insulation terminated by 2 elbowed male safety plugs (4 mm)

Safety specifications

Electrical safety:

600 V category III, pollution 2

300 V category IV, pollution 2

Electromagnetic compatibility (EMC):

EN 50081-1: class B

EN 50082-2:

- Electrical discharge IEC 1000-4-2

- Radial field IEC 1000-4-3

- Fast transients IEC 1000-4-4

- Magnetic field at 50/60 Hz IEC 1000-4-8

(1) Conditions of reference: 23 °C ±5 °K, 20 to 75 % RH, 48 to 65 Hz, external magnetic field < 40 A/m, no current-carrying conductor nearby, centred test sample, load impedance 1 MΩ

To order	Reference
AC/DC current clamp model E1N with battery and user's manual	P01120030A

odel n insulated AC dC current probe

Current	10 A peak	100 A peak
Output	100 mV/A	10 mV/A

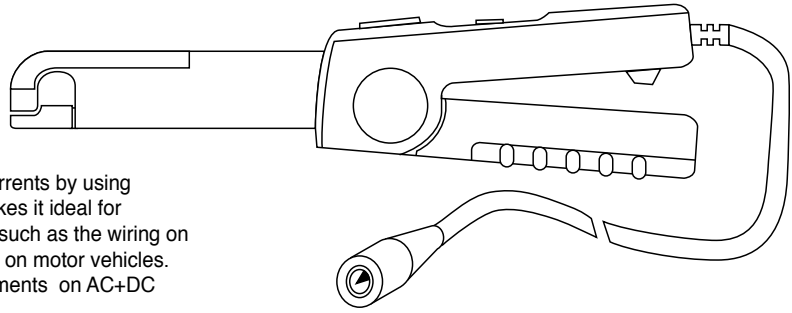

Description

The E3N clamp is designed to measure AC and DC currents by using Hall-effect technology. Its narrow, elongated shape makes it ideal for measurements in cable bundles or in confined spaces such as the wiring on switchboards, motor control units and electrical circuits on motor vehicles. It is particularly appreciated for its True RMS measurements on AC+DC signals. It offers 2 different sensitivities.

Electrical specifications

Current calibres:

0.1 A AC...20 A AC (60 A peak)
0.5 A AC...200 A AC (600 A peak)

Output signal:

100 mV AC+DC / A AC+DC (1 V for 10 A)
10 mV AC+DC / A AC+DC (1 V for 100 A)

Accuracy and phase shift ⁽¹⁾:

Calibre	10 A	100 A	
Current range	50 mA...10 A peak	50 mA...40 A peak	40 A...100 A peak
Accuracy in % of output signal	≤ 3 % + 5 mV	≤ 4 % + 500 μV	≤ 15 %
Phase shift	≤ 1.5°	≤ 1°	≤ 1°

Bandwidth:

DC...100 kHz (-3 dB) (depending on current value)

Rise/fall time from 10 % to 90 %:

- 10 A calibre: 3 μs
- 100 A calibre: 4 μs

10 % delay time:

- 10 A calibre: 2.7 μs
- 100 A calibre: 1.8 μs

Insertion impedance (at 10 kHz / 50 kHz):

< 1.3 mΩ / < 10 mΩ

DC zero adjustment:

20 turns of potentiometer

Typical output noise level (peak-peak) from DC to 100 kHz:

- 10 A calibre: 6 mV
- 100 A calibre: 600 μV

Battery:

9 V alkaline (NEDA 1604A, IEC 6LR61)

Battery life:

55 hours typical

Typical consumption:

8.6 mA typical / 12 mA max.

Battery level indicator:

Green LED when > 6.5 V

Overload indicator:

Red LED indicates the measured current is too high for the selected range

Influence of temperature:

≤ 2000 ppm /°C

Influence of conductor position in jaws:

≤ 0.5 % of output signal at 1 kHz

Common mode voltage (600 V max) for AC measurements (typical / max):

- 10 A calibre:
at 50 Hz: 3.48 mA/100 V / 5 mA/100 V
at 400 Hz: 25.91 mA/100 V / 50 mA/100 V
- 100 A calibre: not measurable

Mechanical specifications

Clamping capacity:

Cable: Ø max 11.8 mm

Output:

Via 2 m coaxial cable terminated by BNC insulated plug.

Dimensions:

231 x 67 x 36 mm

Weight:

330 g with battery

Operating temperature:

0° to +50 °C

Storage temperature:

-30 °C to +80 °C

Relative humidity for operation:

0 to 85 % RH with a linear decrease above 35°C

Operating altitude:

0 to 2,000 m

Casing protection rating:

IP20 (IEC 529)

Drop test:

1 m (IEC 68-2-32)

Shock resistance:

100 g / 6 ms / half-period (IEC 68-2-27)

Vibration resistance:

10/55/10 Hz, 0.15 mm (IEC 68-2-6)

Self-extinguishing capability:

UL94 V2

Colour:

Dark grey

Safety specifications

Electrical safety:

Instrument with double insulation or reinforced insulation between the primary, the secondary and the grippable part located under the guard as per IEC 1010-1 & IEC 1010-2-032

- 600 V category III, pollution degree 2
- 300 V category IV, pollution degree 2

Electromagnetic compatibility (EMC):

EN 50081-1: class B

EN 50082-2:

- Electrostatic discharge IEC 1000-4-2:

- Fast transients IEC 1000-4-4:

- 1 kV level 2 performance criterion B
- 2 kV level 3 performance criterion B

- Magnetic field at the network frequency (IEC 1000-4-8):
field of 400 A/m at 50 Hz: < 1 A

odel n insulated AC dC current probe

Curves

100 A calibre

Linearity with DC

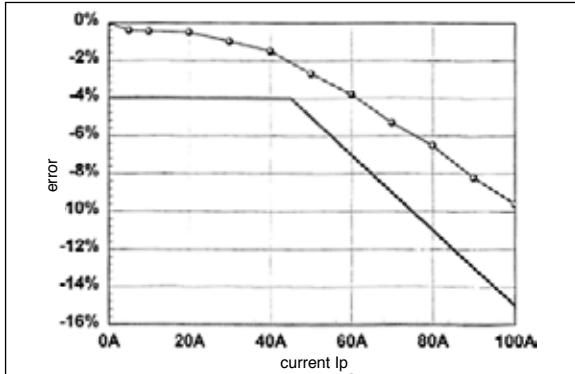

Frequency response

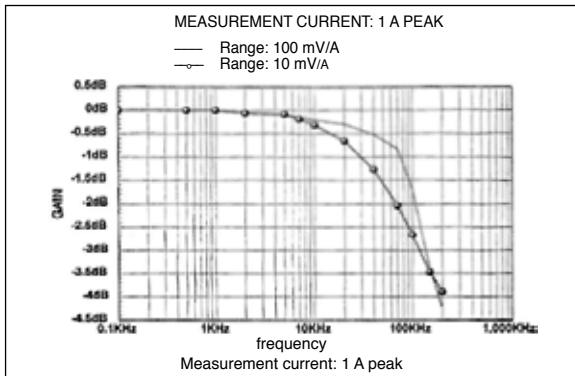

Phase shift

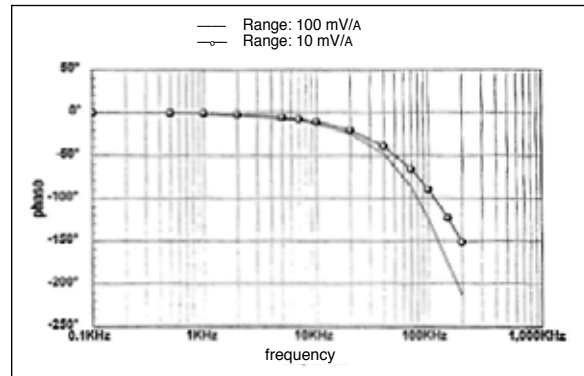

Immunity regarding an external conductor

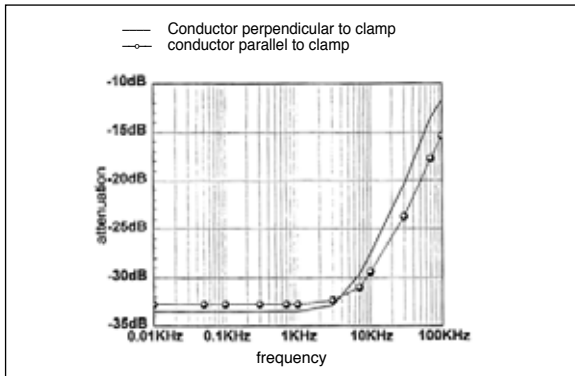

Limitation of measurable current according to the frequency

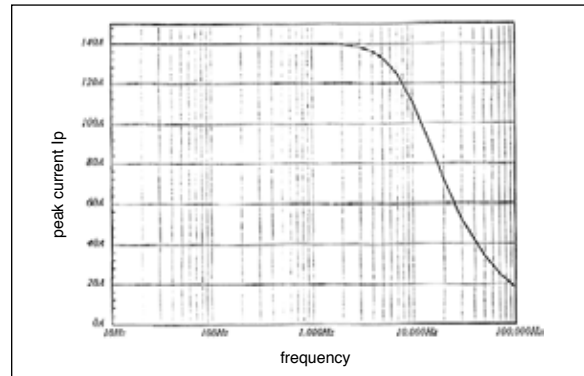

odel n insulated AC dC current probe

Curves

100 A calibre

1 A peak

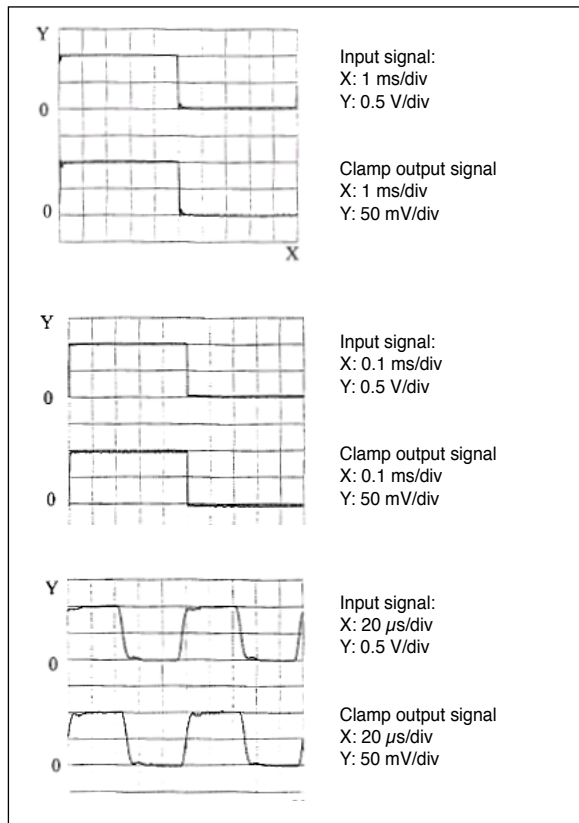

2 A peak

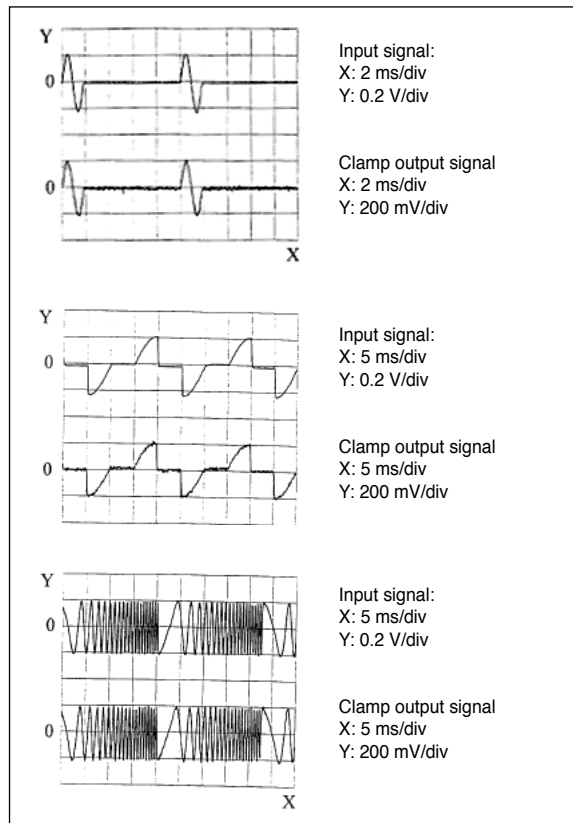

0.1 A peak

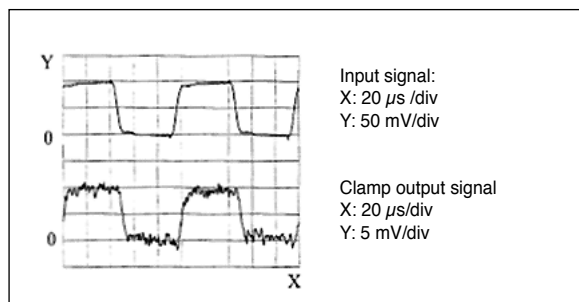

odel n insulated AC dC current probe

Curves

10 A calibre

10 A peak

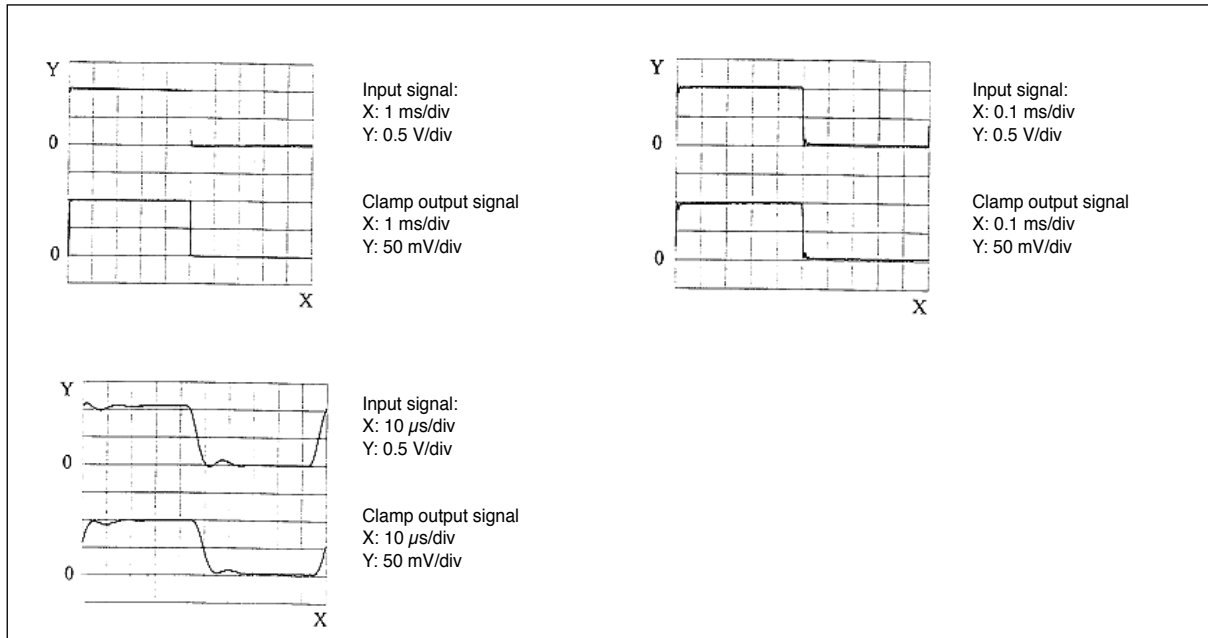

Insertion impedance

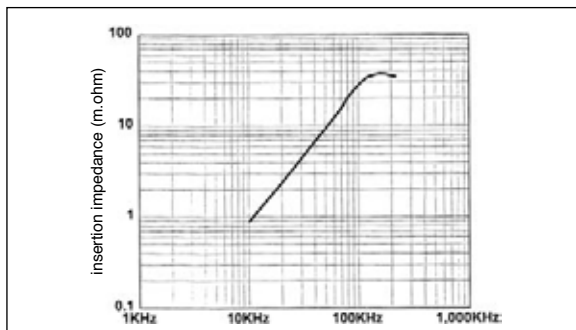

(1) Conditions of reference: 23 °C ± 5 °K, 20 % to 75 % RH, power supply voltage 8 V ± 0.1 V DC sinusoidal signal with frequency of DC at 1 kHz, external magnetic field < 40 A/m, no DC components, no external conductor with circulating current, conductor centred for measurement, load impedance >1 MΩ / < 100 pF.

To order	Reference
Oscilloscope clamp for AC/DC current model E3N , with battery and user's manual	P01120043A
Oscilloscope clamp for AC/DC current model E3N , with mains power pack, battery and user's manual	P01120047

Calibre	2 A AC/DC	80 A AC/DC
Output	1 mV/mA	10 mV/A

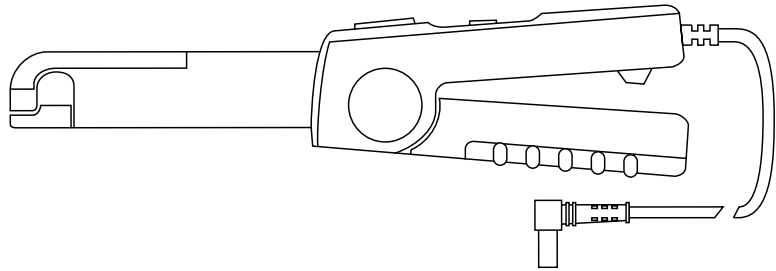

■ Electrical specifications

Current range:

5 mA...80 A AC/DC over two calibres

Output signal:

1 mV/mA and 10 mV/A AC or DC

Accuracy and phase shift ⁽¹⁾:

Calibre	1 mV/mA (1 V/A)	10 mV/A
Current range	5 mA...2 A DC 5 mA...1.5 A AC	20 mA...80 A DC 20 mA...80 A AC
% Accuracy of output signal	2 % ± 5 mV	20 mA...50 A DC: 4 % ± 200 μV 50 A to 80 A DC: 12 % 20 mA...40 A AC: 4 % ± 200 μV 40 A to 60 A AC: 12 %
Frequency range	DC...2 kHz	DC...8 kHz
Phase shift	DC...65 Hz: 1°	DC...65 Hz: 1°
Min load impedance	> 10 kΩ	> 2 kΩ
Noise	DC...1 Hz: 2 mV 1 Hz...10 kHz: 10 mV 10...100 kHz: 10 mV	DC...1 Hz: 20 μV 1 Hz...10 kHz: 100 μV 10...100 kHz: 100 μV

Overload:

120 A continuous

Operating voltage:

600 V rms max

Common mode voltage:

600 V rms max

Battery:

9 V alkaline (NEDA 1604A, IEC 6LR61)

Battery life:

70 hours typical

Typical consumption:

6 mA

Battery level indicator:

Green LED when > 6.5 V

Operating altitude:

0 to 2,000 m

Max. jaw insertion capacity:

11.8 mm

Zero adjustment:

20 turns of potentiometer (± 1.5 A min)

Drop test:

1 m on a 38 mm container of oak on concrete, test in accordance with IEC 1010

Shock resistance:

100 g, in accordance with IEC 68-2-27

Vibration resistance:

10/55/10 Hz, 0.15 mm test in accordance with IEC 68-2-6

Casing protection rating:

IP20 in accordance with IEC 529

Self-extinguishing capability:

Casing: UL94 V2

Dimensions:

231 x 36 x 67 mm

Weight:

330 g with batteries

Colour:

Dark grey

Output:

Via 1.5 m two-wire cable with reinforced or double insulation, terminated by two elbowed 4 mm male safety plugs.

■ Safety specifications

Electrical safety:

600 V category III, pollution: 2

300 V category IV, pollution: 2

Electromagnetic compatibility (EMC):

EN 50081-1: class B

EN 50082-2:

- Electrical discharge IEC 1000-4-2

- Radial field IEC 1000-4-3

- Fast transients IEC 1000-4-4

- Magnetic field at 50/60 Hz IEC 1000-4-8

■ Mechanical specifications

Operating temperature:

0 °C to +50 °C

Storage temperature:

-30 °C to +80 °C

Influence of temperature:

< 0.2 % per °C

Relative humidity for operation:

+10 °C to +30 °C:

85 ± 5 % RH (without condensation)

+40 °C to +50 °C:

45 ± 5 % RH (without condensation)

(1) Conditions of reference: 23 °C ±5 °K, 20 to 75 % RH, 48 to 65 Hz, external magnetic field < 40 A/m, no current-carrying conductor nearby, centred test sample, load impedance 1 MΩ

To order	Reference
AC/DC current clamp model E6N with battery and user's manual	P01120040A



PAC series

The PAC series is a range of professional AC/DC current clamps.

There are two different jaw designs available for clamping cables and small busbars.

The PAC series clamps operate on the Hall effect principle, allow current measurement up to 1500 A DC and 1000 A AC. The electronics and the batteries are all located in the clamp handles. There are two sensitivity levels available: 1 mV/A and 10 mV/A.

A push button operates the automatic DC zeroing on models PAC 11, 12, 21 and 22.

Models PAC 10 and PAC 20 have potentiometer-operated zero adjustment.

TRMS measurement with the DC component is possible using a multimeter or power meter with suitable capabilities.

Models PAC 12 and PAC 22 are designed for use with oscilloscopes and other BNC-input instruments.

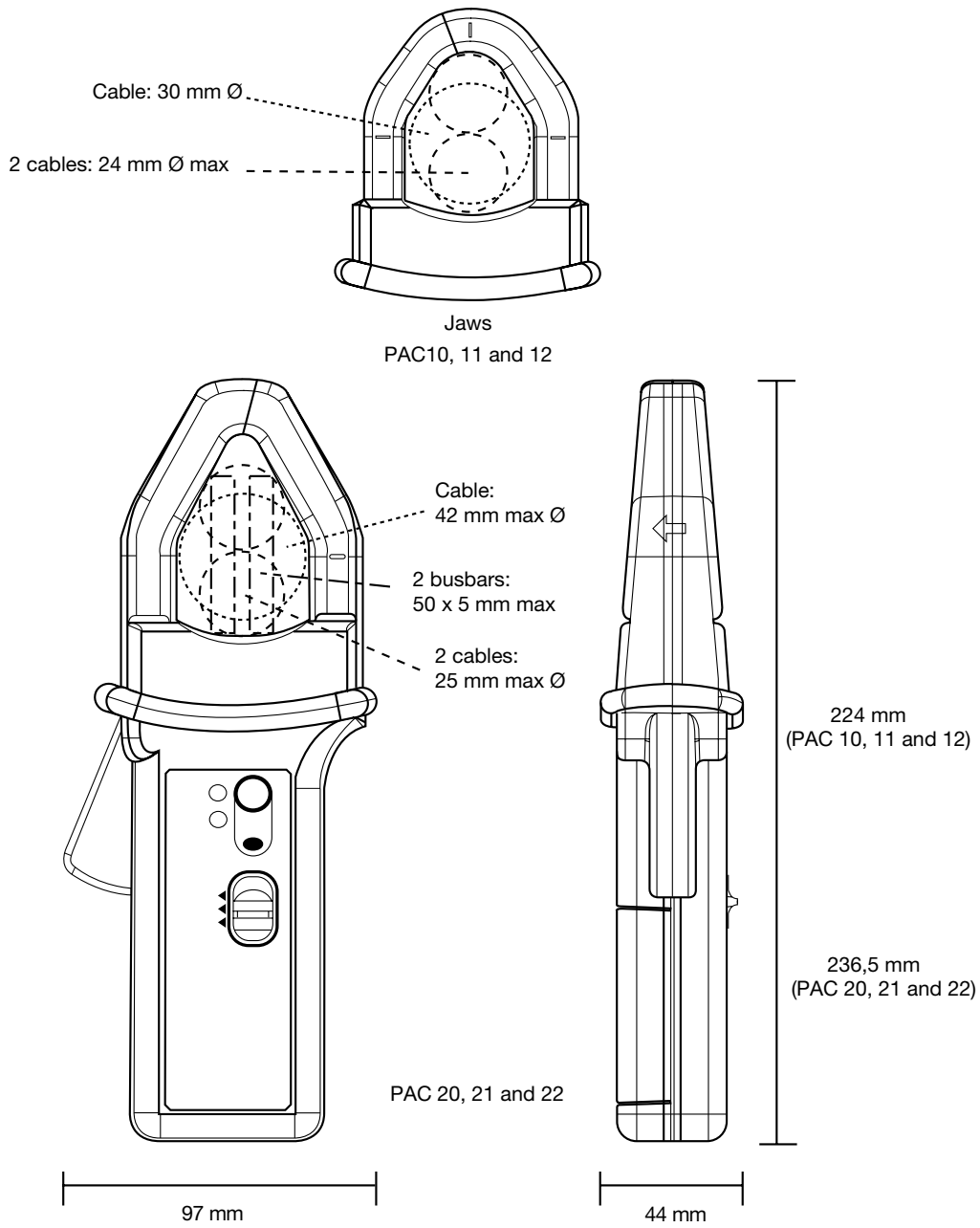

Current clamp for AC dC current

odel AC

PAC series

Current	400 A AC 600 A DC
Output	1 mV/A

Description

Model PAC10 operates using the Hall effect, for precise measurement of AC or DC currents.

It has a mV output so that a direct reading may be made on a multimeter or logging equipment, etc.

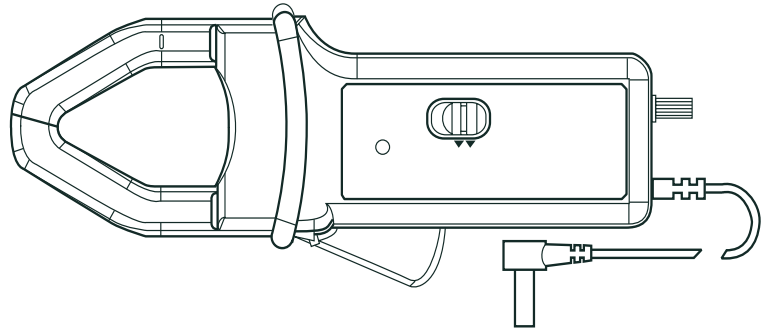

Electrical specifications

Current calibres:
0.5 A AC to 400 A AC (600 A peak)
0.5 A AC to 600 A DC

Output signal: 1 mV/A

Accuracy ⁽¹⁾:

Current range	1 A ... 100 A	100 A ... 400 A
Accuracy in % of output signal	1.5 % ± 1 mV	2 % 400 A ... 600 A DC: 2.5 %

Phase shift ⁽¹⁾:

Current range	10 A ... 200 A	200 A ... 400 A
Phase shift 45 Hz...65 Hz	< 2.5°	< 2°

Overload:

2000 A DC and 1000 A AC up to 1 kHz

Bandwidth:

DC...5 kHz

Noise:

DC at 1 kHz: < 1 mV
DC at 5 kHz: < 1.5 mV
0.1 Hz at 5 kHz: < 500 µV

Load impedance:

1 MΩ and ≤ 100 pF

Insertion impedance:

0.39 mΩ at 50 Hz, 58 mΩ at 1000 Hz

Rise time and fall time:

< 100 µs from 10 % to 90 % of the voltage value

Operating voltage:

600 V rms

Common mode voltage:

600 V rms

Influence of adjacent conductor:

< 10 mA/A at 50 Hz

Influence of conductor position in jaws:

0.5 % of the reading

Battery:

9 V alkaline (NEDA 1604 A, IEC 6LR61)

Low battery signal:

Green LED when the battery voltage > 6.5 V

Battery life:

120 hours with Alkaline battery

Mechanical specifications

Operating temperature:

-10 °C to +55 °C

Storage temperature:

-40 °C to +80 °C

Relative humidity for operation:

+10 °C to +35 °C: 90 ± 5 % RH (without condensation)
+40 °C to +55 °C: 70 ± 5 % RH (without condensation)

Influence of temperature:

< 300 ppm/°K or 0.3 %/10 °K
< 0.3 A/°K

Influence of humidity:

10 % to 90 % RH at reference temperature:
< 0.1 %

Operating altitude:

0 to 2,000 m

DC zero adjustment:

±12 A (10-turn potentiometer)

Max. jaw insertion capacity:

1 cable Ø 30 mm or 2 cables Ø 24 mm

Casing protection rating:

IP30 in accordance with IEC 529

Drop test:

1 m on a 38 mm container of oak on concrete, test in accordance with IEC 1010

Shock resistance:

100 g, in accordance with IEC 68-2-27

Vibration resistance:

Test in accordance with IEC 68-2-6

Frequency range:

5 Hz to 15 Hz: amplitude: 1.5 mm
15 Hz to 25 Hz: amplitude: 1 mm
25 Hz to 55 Hz: amplitude: 0.25 mm

Self-extinguishing capability:

Casing and jaws: UL94 V0

Dimensions:

224 x 97 x 44 mm

Weight:

440 g

Colours:

Dark grey and red jaws

Output:

via 1.5 m double insulated cable with 4 mm male safety plug

Safety specifications

Electrical safety:

double or reinforced insulation between the primary, the secondary and outer casing in accordance with IEC 1010-1-2 (indoor use).
600 V category III, pollution 2
300 V category IV, pollution 2

Electromagnetic compatibility (EMC):

EN 50081-1: class B
EN 50082-2:
- Electrical discharge IEC 1000-4-2
- Radial field IEC 1000-4-3
- Fast transients IEC 1000-4-4
- Magnetic field at 50/60 Hz IEC 1000-4-8

(1) Conditions of reference: 18 °C at 28 °C, 20 % to 75 % RH, 48 to 65 Hz, external magnetic field < 40 A/m, no DC component, no current-carrying conductor nearby, centred test sample, charge ≥ 1 MΩ and ≤ 100 pF, reset to zero before measurement (only DC) DC to 65 Hz, batteries 9 V ± 0.1 V

To order	Reference
AC/DC current clamp model PAC10 with battery and user's manual	P01120070
AC/DC current clamp model PAC10 in carrying case with battery and user's manual	P01120070D

odel AC““

Current	40 A AC 60 A DC	400 A AC 600 A DC
Output	10 mV/A	1 mV/A

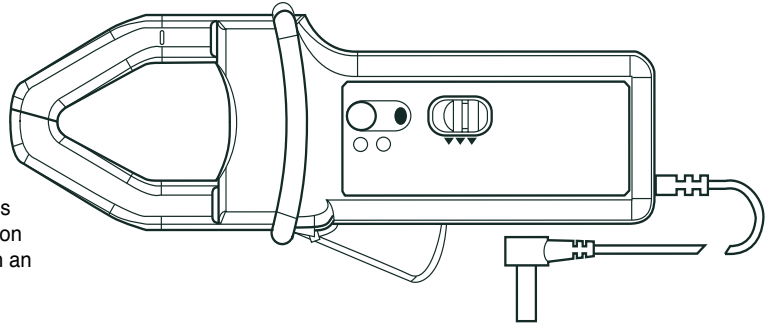

Description

The PAC11 model accurately measures AC or DC currents using the Hall-effect principle. This clamp with mV output on BNC (direct reading on multimeters, etc.) is equipped with an automatic DC zero system.

Electrical specifications

Calibre	60 A	600 A
Current range	0.2 A ... 40 A (60 A peak) 0.4 A ... 60 A DC	0.5 A ... 400 A (600 A peak) 0.5 A ... 600 A DC
Output signal	10 mV/A	1 mV/A
% Accuracy of output signal ⁽¹⁾	0.5 A...40 A: 1.5 % ±5 mV 40 A...60 A DC: 1.5 %	0.5 A...100 A: 1.5 % ±1 mV 100 A...400 A DC: 2 % 400 A...600 A DC: 2.5 %
Phase shift (45...65 Hz) ⁽¹⁾	10 A...20 A: < 3° 20 A...40 A: < 2°	10 A...100 A: < 2° 100 A...400 A: < 1.5°
Noise	DC...1 kHz: < 8 mV DC...5 kHz: < 12 mV 0.1 Hz...5 kHz: < 2 mV	DC...1 kHz: < 1 mV DC...5 kHz: < 1.5 mV 0.1 Hz...5 kHz: < 500 μV
Rise/fall time	≤ 100 μs from 10 % to 90 % of the voltage value	≤ 70 μs from 10 % to 90 % of the voltage value

Overload:

2000 A DC and 1000 A AC up to 1 kHz

Bandwidth:

DC...10 kHz at -3 dB

Load impedance:

≥ 1 MΩ and ≤ 100 pF

Insertion impedance:

0.39 mΩ at 50 Hz, 58 mΩ at 1000 Hz

Operating voltage:

600 V rms

Common mode voltage:

600 V rms

Influence of adjacent conductor:

< 10 mA/A at 50 Hz

Influence of conductor position in jaws:

0.5 % of the reading

Battery:

9 V alkaline (NEDA 1604 A, IEC 6LR61)

Low battery signal:

Green LED when the battery voltage > 6.5 V

Battery life:

50 hours with Alkaline battery.

Overload indicator:

Red LED

Auto switch-off: 0 minute

Mechanical specifications

Operating temperature:

-10 °C to +55 °C

Storage temperature:

-40 °C to +80 °C

Relative humidity for operation:

+10 °C to +35 °C:

90 ± 5 % RH (without condensation)

+40 °C to +55 °C:

70 ± 5 % RH (without condensation)

Influence of temperature:

< 300 ppm/°K or 0.3 %/10 °K

< 0.3 A/°K

Influence of humidity:

10 % to 90 % RH at reference temperature:

< 0.1 %

Operating altitude:

0 to 2,000 m

DC zero adjustment:

Automatically operated by button (± 10 A)

Max. jaw insertion capacity:

1 cable Ø 30 mm or 2 cables Ø 24 mm or

2 busbars 31.5 x 10 mm

Casing protection rating:

IP30 in accordance with IEC 529

Drop test:

1 m on a 38 mm container of oak on concrete, test in accordance with IEC 1010

Shock resistance:

100 g, in accordance with IEC 68-2-27

Vibration resistance:

Test in accordance with IEC 68-2-6

Frequency range:

5 Hz to 15 Hz: amplitude: 1.5 mm

15 Hz to 25 Hz: amplitude: 1 mm

25 Hz to 55 Hz: amplitude: 0.25 mm

Self-extinguishing capability:

Casing and jaws: UL94 V0

Dimensions:

224 x 97 x 44 mm

Weight:

440 g

Colours:

Dark grey and red jaws

Output:

Via 1.5 m double insulated cable with 4 mm male safety plug

Safety specifications

Electrical safety:

double or reinforced insulation between the

primary, the secondary and outer casing in

accordance with IEC 1010-1-2 (indoor use).

600 V category III, pollution 2

300 V category IV, pollution 2

Electromagnetic compatibility (EMC):

EN 50081-1: class B

EN 50082-2:

- Electrical discharge IEC 1000-4-2

- Radial field IEC 1000-4-3

- Fast transients IEC 1000-4-4

- Magnetic field at 50/60 Hz

IEC 1000-4-8

(1) Conditions of reference: 18° at 28°C, 20 to 75 % RH, 48 to 65 Hz, external magnetic field < 40 A/m, no DC component, no current-carrying conductor nearby, centred test sample, charge ≥ 1 MΩ and ≤ 100 pF, reset to zero before measurement (only DC) DC to 65 Hz, batteries 9 V ±0.1 V

To order	Reference
AC/DC current clamp model PAC11 with battery and user's manual	P01120068
AC/DC current clamp model PAC11 in carrying case with battery and user's manual	P01120068D

odel AC

Current	40 A AC 60 A DC	400 A AC 600 A DC
Output	10 mV/A	1 mV/A

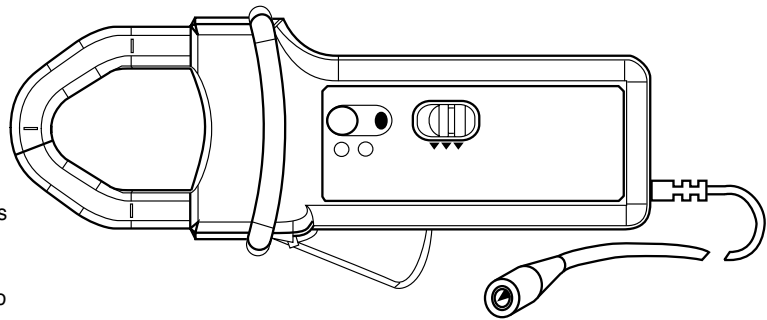

Description

The PAC12 model accurately measures AC or DC currents by using the Hall-effect principle.

This clamp with mV output on BNC (direct reading on oscilloscopes, etc.) is equipped with an automatic DC Zero system.

Electrical specifications

Current calibres:

0.2 A AC...40 A AC (60 A peak) / 0.4 A DC...60 A DC
0.5 A AC...400 A AC (600 A peak) / 0.5 A DC...600 A DC

Output signal:

10 mV AC+DC / A AC+DC (0.6 V for 60 A)
1 mV AC+DC / A AC+DC (0.6 V for 600 A)

Accuracy and phase shift ⁽¹⁾:

60 A calibre

Primary current	0.5 A...10 A	10 A...20 A	20 A...40 A	40 A...60 A (only DC)
Accuracy in % of output signal	≤ 1.5 % + 5 mV	≤ 1.5 % + 5 mV	≤ 1.5 % + 5 mV	≤ 1.5 %
Phase shift	Not specified	≤ 3°	≤ 2.2°	-

600 A calibre

Primary current	0.5 A...10 A	10 A...100 A	100 A...300 A	300 A...400 A	400 A...600 A (only DC)
% Accuracy of output signal	≤ 1.5 % + 1 mV	≤ 1.5 % + 1 mV	≤ 2 %	≤ 2 %	≤ 2.5 %
Phase shift	Not specified	≤ 2.2°	≤ 2.2°	≤ 1.5°	-

Bandwidth:

DC...10 kHz (-3 dB) (depending on current value)

Rise/fall time from 10 % to 90 %:

29 μs

10 % delay time:

15 μs

Insertion impedance (at 400 Hz / 10 kHz):

< 2.7 mΩ / < 72 mΩ

Maximum currents:

3000 A DC or 1000 A AC continuous for a frequency ≤ 1 kHz (limitation proportional to the inverse of one third of the frequency above that)

DC zero adjustment:

Automatic

60 A calibre:

± 10 A in 25 to 40 mA increments

600 A calibre:

± 10 A in 25 to 40 mA increments

Typical output noise level (peak-peak) from DC to 100 kHz:

60 A calibre:

DC to 1 kHz: ≤ 8 mV or 0.8 A DC

DC to 5 kHz: ≤ 12 mV or 1.2 A DC

0.1 Hz to 5 kHz: ≤ 2.0 mV rms or 0.2 A rms

600 A calibre:

DC to 1 kHz: ≤ 1 mV or 1 A DC

DC to 5 kHz: ≤ 1.5 mV or 1.5 A DC

1 Hz to 5 kHz: ≤ 500 μV rms or 0.5 A rms

Battery:

9 V alkaline (NEDA 1604A, IEC 6LR61)

Battery life:

50 hours typical

Typical consumption:

10 mA typical / 14 mA max.

Battery level indicator:

Green LED

Overload indicator:

Red LED indicates if measured current is too high for the selected range

Influence of power supply voltage:

≤ 0.1 % of the reading

Influence of temperature:

Measurement: ≤ 300 ppm/K or 0.3 % of output signal per 10 °K

DC zero: 40 mA/10 °K

Influence of relative humidity:

< 0.5 % of output signal

Influence of adjacent conductor at 23 mm:

≤ 10 mA/A at 50 Hz

Influence of external field:

≤ 1.3 A pour 400 A/m

Influence of Ø 20 mm conductor position in jaws:

DC at 440 Hz: ≤ 0.5 % of the reading

DC at 1 kHz: ≤ 1 % of the reading

DC at 2 kHz: ≤ 3 % of the reading

DC at 5 kHz: ≤ 10 % of the reading

Influence of frequency ⁽²⁾:

< 1 % of output signal from 65 Hz...440 Hz

< 3.5 % of output signal from 440 Hz...2 kHz

3 dB % of output signal from 2 kHz...10 kHz

Common mode rejection:

> 65 dB A/V at 50 Hz

Remanence:

0 to 50 A DC: 0.8 A typical

0 to 100 A DC: 1.3 A typical

0 to 200 A DC: 2.1 A typical

0 to 400 A DC: 3.3 A typical

0 to 600 A DC: 4.0 A typical

oscilloscope clamp for AC dC current odel AC“”

PAC series

■ Mechanical specifications

Max. jaw opening:
31 mm

Clamping capacity:

Cables: Ø 30 mm
 Ø 24 mm x 2
Bars: 1 busbar 50 x 10 mm
 2 busbars 31.5 x 10 mm
 3 busbars 25 x 8 mm
 4 busbars 25 x 5 mm

Output:

Coaxial cable 2 m long, terminated by an insulated BNC connector

Dimensions:

224 x 97 x 44 mm

Weight:

440 g with battery

Operating temperature:

-10 °C to +55 °C

Storage temperature:

-40 °C to +80 °C

Relative humidity for operation:

0 to 85 % RH with a linear decrease above 35 °C

Operating altitude:

0 to 2,000 m

Casing protection rating:

IP40 (IEC 529)

Drop test:

1 m (IEC 68-2-32)

Shock resistance:

100 g / 6 ms / half-period (IEC 68-2-27)

Protection against impacts:

IK04 0.5 J (EN 50102)

Vibration resistance:

5-15 Hz: 1.5 mm peak
15-25 Hz: 1 mm peak
25-55 Hz: 0.25 mm peak
(IEC 68-2-6)

Self-extinguishing capability:

UL94 V2

Colours:

Dark grey casing with red jaws

■ Safety specifications

Electrical safety:

Instrument with double insulation or reinforced insulation between the primary, the secondary and the grippable part located under the guard as per IEC 1010-1 & IEC 1010-2-032

- 600 V category III, pollution degree 2
- 300 V category IV, pollution degree 2

Electromagnetic compatibility (EMC):

EN 50081-1: class B

EN 50082-2:

- Electrostatic discharge IEC 1000-4-2:
 - 4 kV in contact, performance criterion B
 - 8 kV in the air, performance criterion B
- Radiated field IEC 1000-4-3:
 - 3 V/m level 2: influence < 5 % of measurement range
- Fast transients IEC 1000-4-4:
 - 1 kV performance criterion B
- Magnetic field at the network frequency IEC 1000-4-8:
 - field of 30 A/m at 50 Hz level 4 performance criterion A
- Conducted disturbances (IEC 1000-4-6):
 - 3 V performance criterion A

(1) Conditions of reference: 23 °C ± 5 °K, 20 % at 75 % RH, power supply voltage 9 V ± 0.1 V DC sinusoidal signal with frequency of DC to 65 Hz, external magnetic field < 40 A/m, no DC components, no external conductor with circulating current, conductor centred for measurement, load impedance > 1 MΩ / < 100 pF.

(2) Out of reference domain.

To order	Reference
AC/DC current clamp model PAC12 for oscilloscope with battery and user's manual	P01120072

Curves

60 A calibre

600 A calibre

Linearity with DC

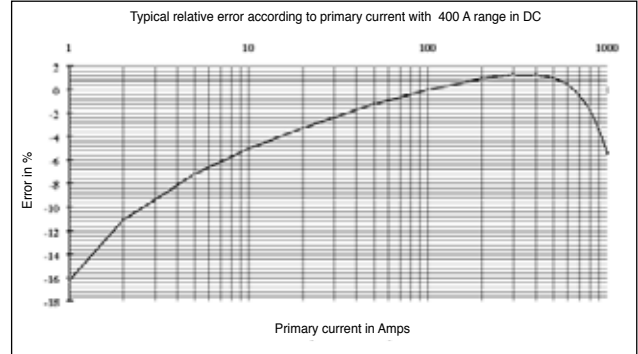
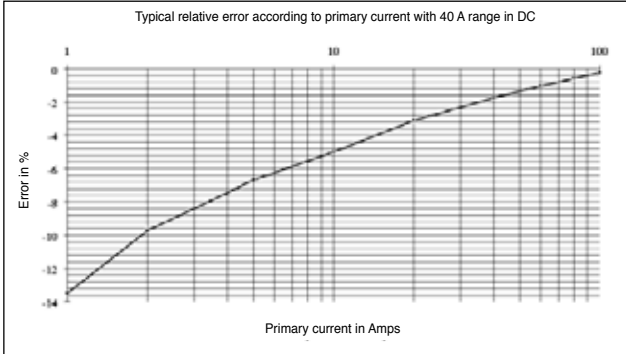

Linearity for AC

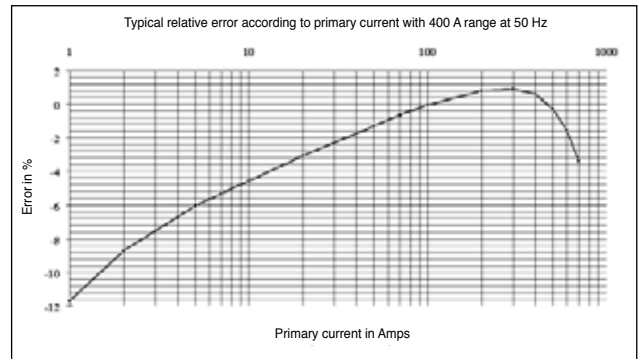
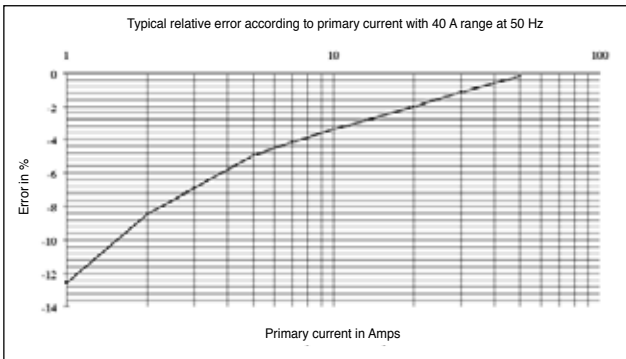

Phase shift

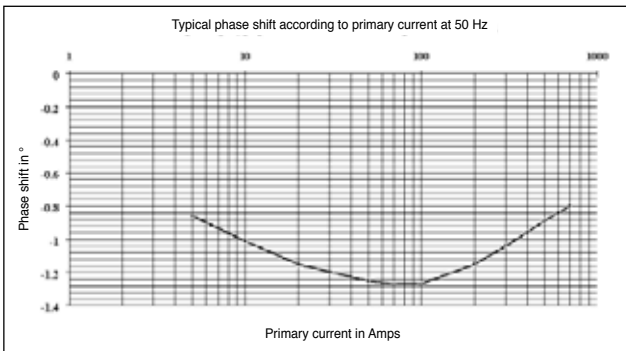

Limitation of measurable current according to the frequency

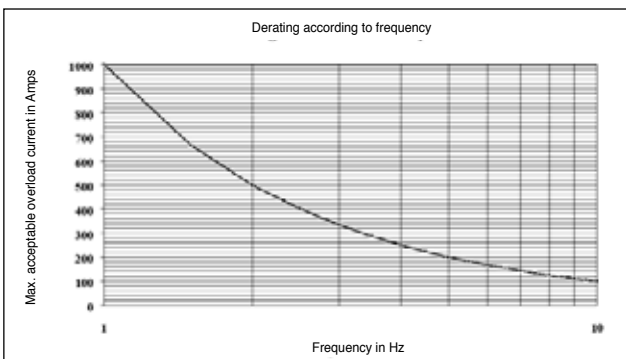

oscilloscope clamp for AC dC current

odel AC

PAC series

Curves

600 A calibre

Frequency response

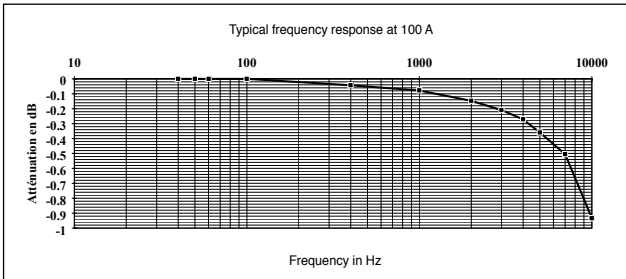

Attenuation according to the frequency

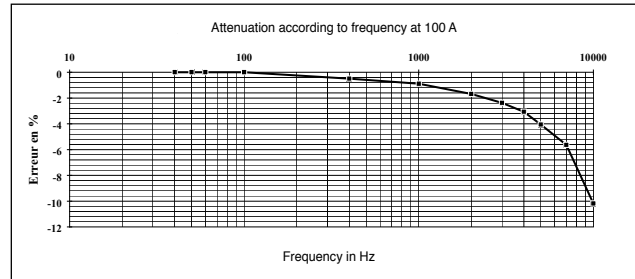

60 A calibre

600 A calibre

Pulse response

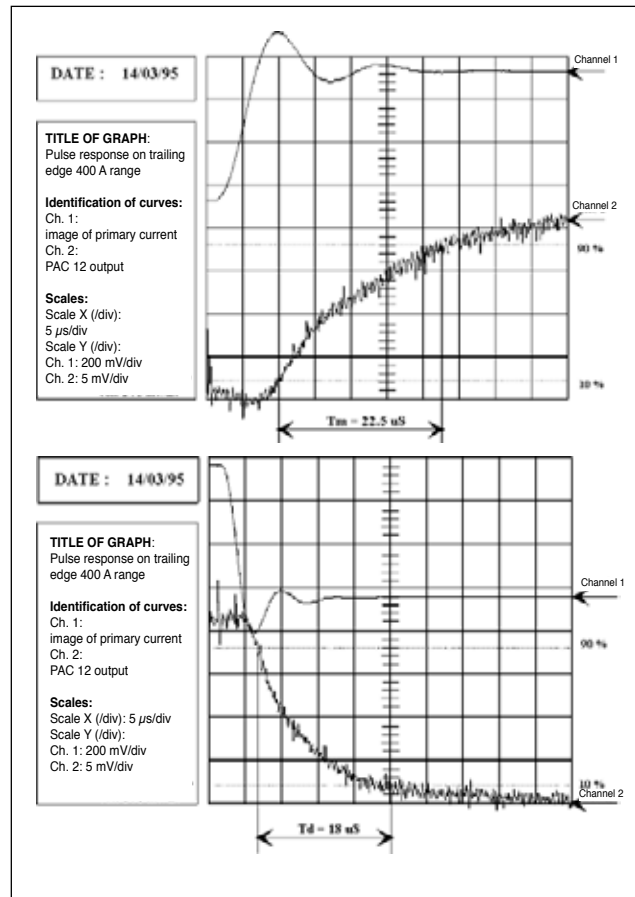
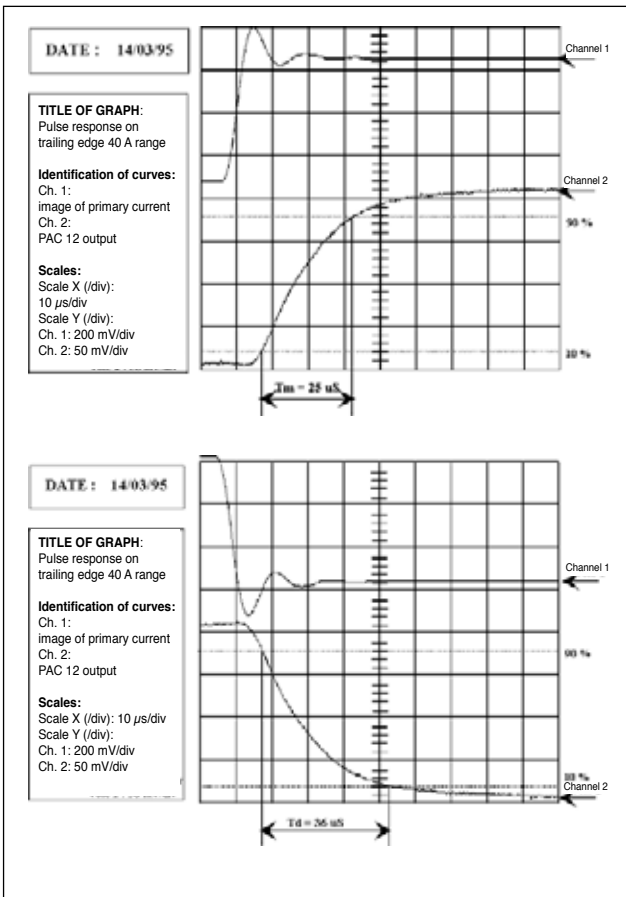

Current clamp for AC dC current

odel AC

PAC series

Current	1000 A AC 1400 A DC
Output	1 mV/A

Description

The PAC20 model accurately measures AC or DC currents by using the Hall-effect principle.

This clamp has a mV output so that direct readings may be made with a multimeter or logging equipment, etc.

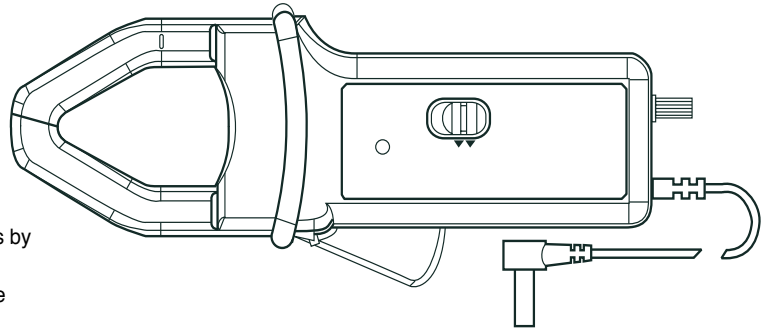

Electrical specifications

Current calibres:

0.5 A...1000 A AC (1400 A peak)

0.5 A...1400 A DC

Output signal:

1 mV/A

Accuracy ⁽¹⁾:

Current range	1 A ...100 A	100 A ...800 A	800 A...1000 A
Accuracy in % of output signal	1.5 % ± 1 mV	2.5 %	4 % 1000 A ...1400 A DC: 4 %

Phase shift ⁽¹⁾:

Current range	10 A ... 200 A	200 A ... 1000 A
Phase shift 45 Hz...65 Hz	< 2.5°	< 2°

Overload:

3000 A DC and 2000 A AC up to 1 kHz

Bandwidth:

DC...5 kHz

Noise:

DC...1 kHz: < 1 mV

DC...5 kHz: < 1.5 mV

0.1 Hz...5 kHz: < 500 µV

Load impedance:

> 100 kΩ at 100 pF

Insertion impedance:

0.39 mΩ at 50 Hz, 58 mΩ at 1000 Hz

Rise/fall time:

Rise:

< 100 µs from 10 % to 90 % of the voltage value

Fall:

< 100 µs from 10 % to 90 % of the voltage value

Operating voltage:

600 V rms

Common mode voltage:

600 V rms

Influence of adjacent conductor:

< 10 mA/A at 50 Hz

Influence of conductor position in jaws:

0.5 % of the reading

Battery:

9 V alkaline (NEDA 1604 A, IEC 6LR61)

Low battery signal:

Green LED when the battery voltage > 6.5 V

Battery life:

120 hours with Alkaline battery

Mechanical specifications

Operating temperature:

-10 °C to +55 °C

Storage temperature:

-40 °C to +80 °C

Relative humidity for operation:

+10 °C to +35 °C: 90 ± 5 % RH (without condensation)

+40 °C to +55 °C: 70 ± 5 % RH (without condensation)

Influence of temperature:

< 300 ppm/°K or 0.3 %/10 °K
< 0.3 A/°K

Influence of humidity:

10 %...90 % RH at reference temperature:
< 0.1 %

Operating altitude:

0 to 2,000 m

Zero adjustment:

±12 A (10-turn potentiometer)

Max. jaw insertion capacity:

1 cable Ø 42 mm, 2 cables Ø 25.4 mm or 2 busbars 50 x 5 mm

Casing protection rating:

IP30 in accordance with IEC 529

Drop test:

1 m on a 38 mm container of oak on concrete, test in accordance with IEC 1010

Shock resistance:

100 g, in accordance with IEC 68-2-27

Vibration resistance:

Test in accordance with IEC 68-2-6

Frequency range:

5 to 15 Hz: amplitude: 1.5 mm

15 to 25 Hz: amplitude: 1 mm

25 to 55 Hz: amplitude: 0.25 mm

Self-extinguishing capability:

Casing and jaws: UL 94 V0

Dimensions:

236.5 x 97 x 44 mm

Weight:

520 g

Colours:

Dark grey and red jaws

Output:

via 1.5 m double insulated cable with 4 mm male safety plug

Safety specifications

Electrical safety:

double or reinforced insulation between the primary the secondary and outer casing in accordance with IEC 1010-1-2 (indoor use).

600 V category III, pollution 2

300 V category IV, pollution 2

Electromagnetic compatibility (EMC):

EN 50081-1: class B

EN 50082-2:

- Electrical discharge IEC 1000-4-2

- Radial field IEC 1000-4-3

- Fast transients IEC 1000-4-4

- Magnetic field at 50/60 Hz

IEC 1000-4-8

(1) Conditions of reference: 18 °C at 28 °C, 20 % to 75 % RH, 48 Hz to 65 Hz, external magnetic field < 40 A/m, no DC component, no current-carrying conductor nearby, centred test sample, charge ≥ 1 MΩ and ≤ 100 pF, reset to zero before measurement (only DC) DC to 65 Hz, battery 9 V ±0.1 V

To order	Reference
AC/DC current clamp model PAC20 with battery and user's manual	P01120071
AC/DC current clamp model PAC20 in carrying case with battery and user's manual	P01120071D

odel AC”“

Current	100 A AC 150 A DC	1000 A AC 1500 A DC
Output	10 mV/A	1 mV/A

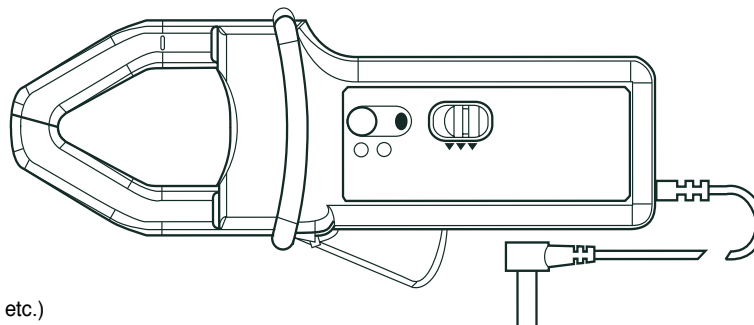

■ Description

The PAC21 model accurately measures AC or DC currents using the Hall-effect principle.

This clamp with mV output (direct reading on multimeters, etc.) is equipped with an automatic DC zero system.

■ Electrical specifications

Calibre	150 A	1400 A
Current range	0.2 A ... 100 A (150 A peak) 0.4 A ... 150 A DC	0.5 A ... 1000 A (1400 A peak) 0.5 A ... 1400 A DC
Output signal	10 mV/A	1 mV/A
% Accuracy of output signal ⁽¹⁾	0.5 A...20 A: 1.5 % ±5 mV 20 A...100 A DC: 1.5 % 100 A...150 A DC: 2.5 %	0.5 A...100 A: 1.5 % ±1 mV 100 A...800 A DC: 2.5 % 800 A...1000 A DC: 4 % 1000 A...1400 A DC: 4 %
Phase shift (45...65 Hz) ⁽¹⁾	10 A...20 A: < 3° 20 A...100 A: < 2°	10 A...200 A: < 2° 200 A...1000 A: < 1.5°
Noise	DC...1 kHz: < 8 mV DC...5 kHz: < 12 mV 0.1 Hz...5 kHz: < 2 mV	DC...1 kHz: < 1 mV DC...5 kHz: < 1.5 mV 0.1 Hz...5 kHz: < 500 μV
Rise/fall time	≤ 100 μs from 10 % to 90 % of the voltage value	≤ 70 μs from 10 % to 90 % of the voltage value

Overload:

3000 A DC and 2000 A AC up to 1 kHz

Bandwidth:

DC...10 kHz at -3 dB

Load impedance:

≥ 1 MΩ and ≤ 100 pF

Insertion impedance:

0.39 mΩ at 50 Hz, 58 mΩ at 1000 Hz

Operating voltage:

600 V rms

Common mode voltage:

600 V rms

Influence of adjacent conductor:

< 10 mA/A at 50 Hz

Influence of conductor position in jaws:

0.5 % of the reading

Battery:

9 V alkaline (NEDA 1604 A, IEC 6LR61)

Low battery signal:

Green LED when the battery voltage > 6.5 V

Battery life:

50 hours Alkaline battery

Overload indicator:

red LED

Auto switch-off:

10 minutes

■ Mechanical specifications

Operating temperature:

-10 °C to +55 °C

Storage temperature:

-40 °C to +80 °C

Relative humidity for operation:

+10 °C to +35°C: 90 ± 5 % RH (without condensation)

+40 °C to +55 °C: 70 ± 5 % RH (without condensation)

(without condensation)

Influence of temperature:

< 300 ppm/°K or 0.3 %/10 °K

< 0.3 A/°K

Influence of humidity:

10 % to 90 % RH at reference temperature:

< 0.1 %

Operating altitude:

0 to 2,000 m

Zero adjustment:

± 10 A by pushbutton

Max. jaw insertion capacity:

1 cable Ø 42 mm, 2 cables Ø 25.4 mm or

2 busbars 50 x 5 mm

Casing protection rating:

IP30 in accordance with IEC 529

Drop test:

1 m on a 38 mm container of oak on concrete, test in accordance with IEC 1010

Shock resistance:

100 g, in accordance with IEC 68-2-27

Vibration resistance:

test in accordance with IEC 68-2-6

Frequency range:

5 to 15 Hz: amplitude: 1.5 mm

15 to 25 Hz: amplitude: 1 mm

25 to 55 Hz: amplitude: 0.25 mm

Self-extinguishing capability:

Casing and jaws: UL94 V0

Dimensions:

236.5 x 97 x 44 mm

Weight:

520 g

Colours:

Dark grey and red jaws

Output:

Via 1.5 m double insulated cable with 4 mm male safety plug

■ Safety specifications

Electrical safety:

double or reinforced insulation between the primary, the secondary and outer casing in accordance with IEC 1010-1-2 (indoor use).

600 V category III, pollution 2

300 V category IV, pollution 2

Electromagnetic compatibility (EMC):

EN 50081-1: class B

EN 50082-2:

- Electrical discharge IEC 1000-4-2

- Radial field IEC 1000-4-3

- Fast transients IEC 1000-4-4

- Magnetic field at 50/60 Hz

IEC 1000-4-8

(1) Conditions of reference: 18 °C at 28 °C, 20 % to 75 % RH, 48 Hz to 65 Hz, external magnetic field < 40 A/m, no DC component, no current-carrying conductor nearby, centred test sample, charge ≥ 1 MΩ and ≤ 100 pF, reset to zero before measurement (only DC) DC to 65 Hz, battery 9 V ±0.1 V

To order	Reference
AC/DC current clamp model PAC21 with battery and user's manual	P01120069
AC/DC current clamp model PAC21 in carrying case with battery and user's manual	P01120069D

odel AC"'" insulated current probe

Current	100 A AC 150 A DC	1000 A AC 1400 A DC
Output	10 mV/A	1 mV/A

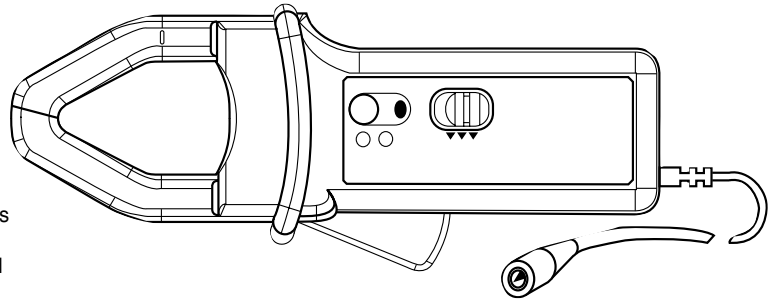

■ Description

The PAC22 model accurately measures AC or DC currents using the Hall-effect principle. This clamp with mV output on BNC (direct reading on oscilloscopes, etc.) is equipped with an automatic DC zero system.

■ Electrical specifications

Current calibres:

0.2 A AC...100 A AC (150 A peak) / 0.4 A DC...150 A DC

0.5 A AC...1000 A AC (1400 A peak) / 0.5 A DC...1400 A DC

Output signal:

10 mV AC+DC / A AC+DC (1.5 V for 150 A)

1 mV AC+DC / A AC+DC (1.4 V for 1400 A)

Accuracy and phase shift ⁽¹⁾:

150 A calibre

Primary current	0.5 A...10 A	10 A...20 A	20 A...100 A	100 A...150 A (only DC)
Accuracy in % of output signal	≤ 1.5 % + 5 mV	≤ 1.5 % + 5 mV	≤ 1.5 %	≤ 1.5 %
Phase shift	Not specified	≤ 3°	≤ 2.2°	-

1400 A calibre

Primary current	0.5 A...10 A	10 A...100 A	100 A...200 A	200 A...800 A	800 A...1000 A	1000 A...1400 A (only DC)
Accuracy in % of output signal	≤ 1.5 % + 1 mV	≤ 1.5 % + 1 mV	≤ 2.5 %	≤ 2.5 %	≤ 4 %	≤ 4 %
Phase shift	Not specified	≤ 2°	≤ 2°	≤ 1.5°	≤ 1.5°	-

Bandwidth:

DC...10 kHz (-3 dB) (depending on current value)

Rise/fall time from 10 % to 90 %:

24 μs

10 % delay time:

15 μs

Insertion impedance (at 400 Hz / 10 kHz)

< 2.7 mΩ / < 67 mΩ

Maximum currents:

3000 A DC or 1000 A AC continuous for a frequency ≤ 1 kHz (limitation proportional to the inverse of one third of the frequency above that)

DC zero adjustment:

Automatic

■ 60 A calibre:

± 10 A in 25 mA to 40 mA increments

■ 600 A calibre:

± 10 A in 25 mA to 40 mA increments

Typical output noise level (peak-peak) from DC to 100 kHz:

■ 150 A calibre:

DC to 1 kHz: ≤ 8 mV or 0.8 A DC

DC to 5 kHz: ≤ 12 mV or 1.2 A DC

0.1 Hz to 5 kHz: ≤ 2.0 mV rms or 0.2 Arms

■ 1400 A calibre:

DC to 1 kHz: ≤ 1 mV or 1 A DC

DC to 5 kHz: ≤ 1.5 mV or 1.5 A DC

1 Hz to 5 kHz: ≤ 500 μV rms or 0.5 A rms

Output impedance:

100 Ω

Battery:

9 V alkaline (NEDA 1604A, IEC 6LR61)

Battery life: 50 hours typical

Typical consumption:

10 mA typical / 14 mA max.

Battery level indicator:

Green LED

Overload indicator:

Red LED indicates the measured current is too high for the selected range

Influence of power supply voltage:

≤ 0.1 % of the reading

Influence of temperature:

Measurement: ≤ 300 ppm/K or 0.3 % of output signal per 10 °K

DC zero: 40 mA/10 °K

Influence of relative humidity:

< 0.5 % of output signal

Influence of adjacent conductor at 23 mm:

≤ 10 mA/A at 50 Hz

Influence of external field:

≤ 1.3 A for 400 A/m

Influence of Ø 20 mm conductor position in jaws:

DC to 440 Hz: ≤ 0.5 % of the reading

DC to 1 kHz: ≤ 1 % of the reading

DC to 2 kHz: ≤ 3 % of the reading

DC to 5 kHz: ≤ 10 % of the reading

Influence of frequency ⁽²⁾:

< 1 % of output signal from 65 Hz to 440 Hz

< 3.5 % of output signal from 440 Hz to 2 kHz

3 dB % of output signal from 2 kHz to 10 kHz

Common mode rejection:

> 65 dB A/V at 50 Hz

Remanence:

0 to 100 A DC: 1 A typical

0 to 250 A DC: 1,7 A typical

0 to 500 A DC: 2.5 A typical

0 to 1000 A DC: 3.6 A typical

0 to 1400 A DC: 4.4 A typical

odel AC''' insulated current probe

■ Mechanical specifications

Max. jaw opening:
31 mm

Clamping capacity:

Cables: Ø 25.4 mm x 2
Bars: 1 busbar 50 x 12.5 mm
2 busbars 50 x 5 or 31.5 x 10 mm
3 busbars 25 x 8 mm
4 busbars 25 x 5 mm

Output:

Coaxial cable 2 m long, terminated by an insulated BNC connector

Dimensions:

236.5 x 97 x 44 mm

Weight:

520 g with battery

Operating temperature:

-10 °C to +55 °C

Storage temperature:

-40 °C to +80 °C

Relative humidity for operation:

0 to 85 % RH with a linear decrease above 35 °C

Operating altitude:

0 to 2,000 m

Casing protection rating:

IP40 (IEC 529)

Drop test:

1 m (IEC 68-2-32)

Shock resistance:

100 g / 6 ms / half-period (IEC 68-2-27)

Protection against impacts:

IK04 0.5 J (EN 50102)

Vibration resistance:

5-15 Hz: 1.5 mm peak
15-25 Hz: 1 mm peak
25-55 Hz: 0.25 mm peak
(IEC 68-2-6)

Self-extinguishing capability:

UL94 V2

Colours:

Dark grey casing with red jaws

■ Safety specifications

Electrical safety:

Instrument with double insulation or reinforced insulation between the primary, the secondary and the grippable part located under the guard as per IEC 1010-1 & IEC 1010-2-032

- 600 V category III, pollution degree 2
- 300 V category IV, pollution degree 2

Electromagnetic compatibility (EMC):

EN 50081-1: class B

EN 50082-2:

- Electrostatic discharge IEC 1000-4-2:
 - 4 kV in contact, performance criterion B
 - 8 kV in the air, performance criterion B
- Radiated field IEC 1000-4-3:
 - 3 V/m level 2: influence < 5 % of measurement range
- Fast transients IEC 1000-4-4:
 - 1 kV performance criterion B
- Magnetic field at the network frequency (IEC 1000-4-8):
 - field of 30 A/m at 50 Hz level 4 performance criterion A
- Conducted disturbances (IEC 1000-4-6):
 - 3 V performance criterion A

(1) Conditions of reference: 23 °C ± 5 °K, 20 % at 75 % RH, power supply voltage 9 V ± 0.1 V DC sinusoidal signal with frequency of DC to 65 Hz, external magnetic field < 40 A/m, no DC components, no external conductor with circulating current, conductor centred for measurement, load impedance > 1 MΩ / < 100 pF.

(2) Out of reference domain.

To order	Reference
Current clamp for AC/DC current model PAC22 for oscilloscope with battery and user's manual	P01120073

Current clamp for AC dC current

odel AC''' insulated current probe

PAC series

Curves

150 A calibre

1400 A calibre

Linearity in DC

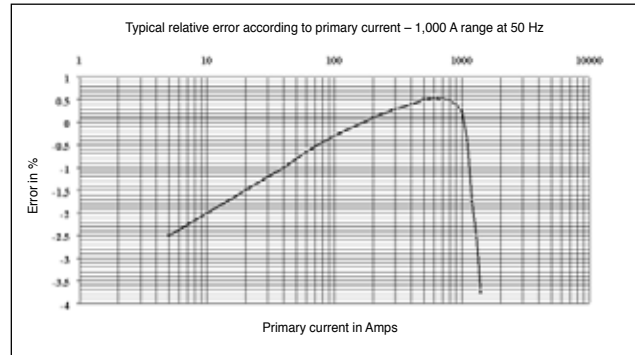
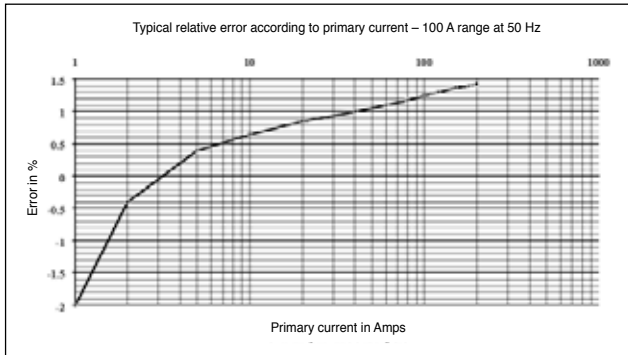

Linearity in AC

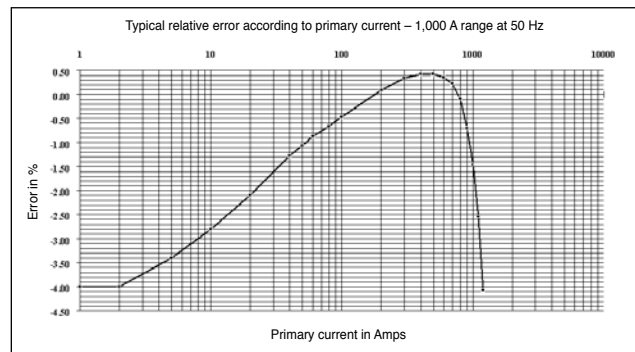
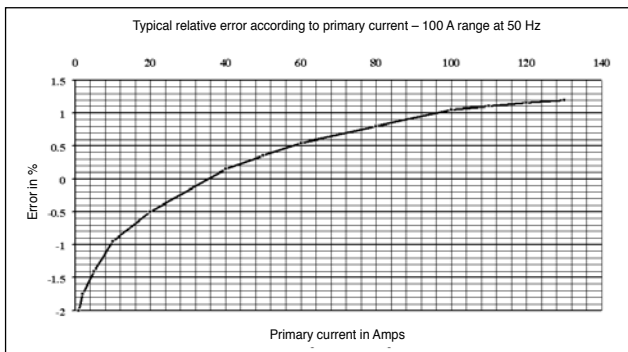

Phase shift

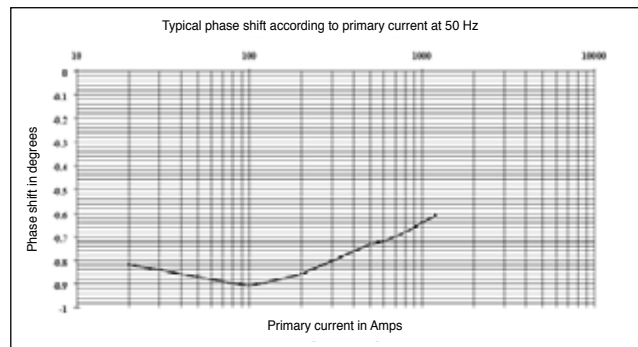

Limitation of measurable current according to the frequency

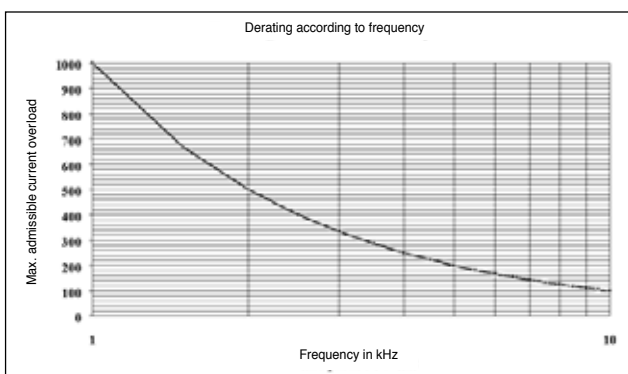

odel AC insulated current probe

Curves

Frequency response

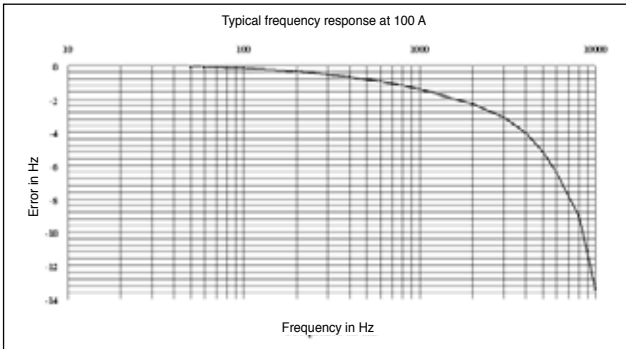

150 A calibre

Attenuation according to frequency

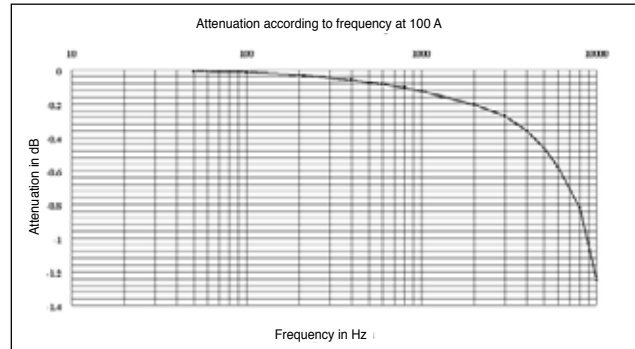

1400 A calibre

Pulse response

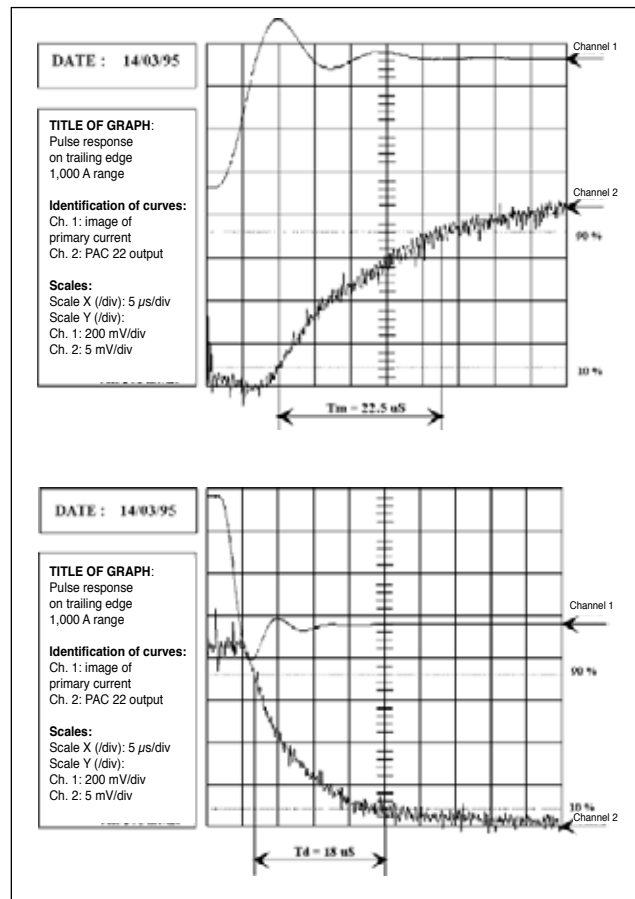
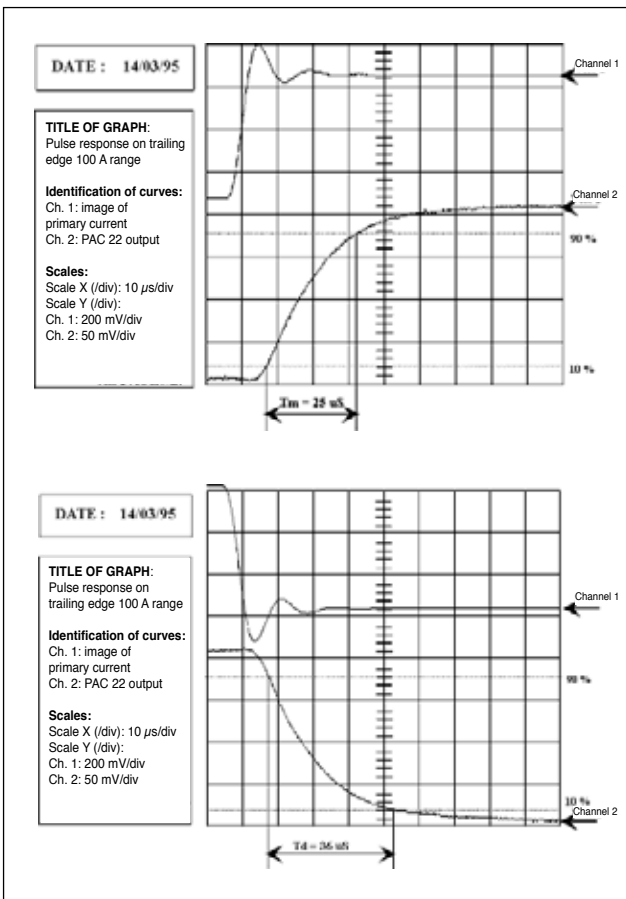



Clamp accessories

Having made test, control and measurement instruments for over a century now, Chauvin Arnoux products are the result of years of experience in the field. A knowledge of measurement techniques and daily experience in safety practices has led to the development of an entire range of practical and safety-conscious test accessories. Throughout the range, from the artificial neutral to the BNC/ female safety socket, or silicone leads with banana plugs (straight or elbowed), the IEC 61010 standard is the benchmark by which all products are judged.

However, even a device that complies with this standard does not guarantee complete safety, so make sure that you are equipped with suitable accessories with which you can verify that your equipment meets the most demanding safety standards.

Mains adapters

For unlimited operation of your current clamps, replace the battery with the mains adapter.

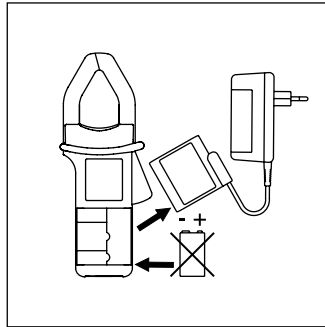

For PAC clamp

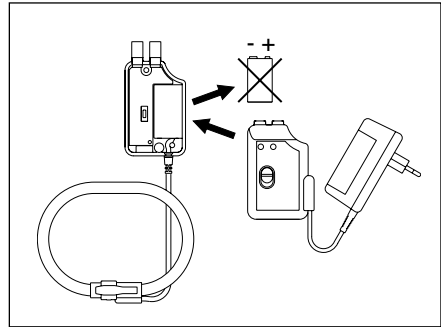

For AmpFLEX™ and MiniFLEX clamps and K clamps

To order	Reference
Mains adapter for K clamp	P01101966
Mains adapter for AmpFLEX A100	P01101968
Mains adapter for PAC clamp	P01101967
Mains adapter for E clamp	P01101965
Mains adapter for MA 100 clamp	P01112086
Mains adapter for MA200 clamp	P01112087

Leads and adapters



Standard PVC leads
 Straight male plug Ø 4 mm
 Elbowed male plug Ø 4 mm
 15 A / 1.5 m
 600 V CAT IV
 1,000 V CAT III



Banana-BNC leads
 Insulated BNC
 Male plug Ø 4 mm
 with rear connection
 500 V CAT III



BNC / banana adapter
 Male BNC
 Female sockets
 500 V CAT I
 150 V CAT III



BNC / banana adapter
 Male BNC
 Male plugs
 500 V CAT I
 150 V CAT III

To order	Reference
Standard PVC leads (1 red + 1 black)	P01295289Z
Banana-BNC leads	AG-1066Z
BNC/banana adapter (set of 2)	P01101846
BNC/banana adapter (set of 2)	P01101847

Artificial neutral box odel An[®]

Accessories

■ Description

This instrument is designed for use with MN73, C173 and B102 leakage-current detection clamps to enable fault current measurements on 3-phase circuits without a neutral conductor.

There is a switch for selecting the test rate so that the MN73, C173 and B clamps can be used with digital or analogue multimeters.

A built-in buzzer indicates when the artificial neutral is connected to the earth. Three LEDs indicate when a voltage is present on each of the 3 phases and during measurement.

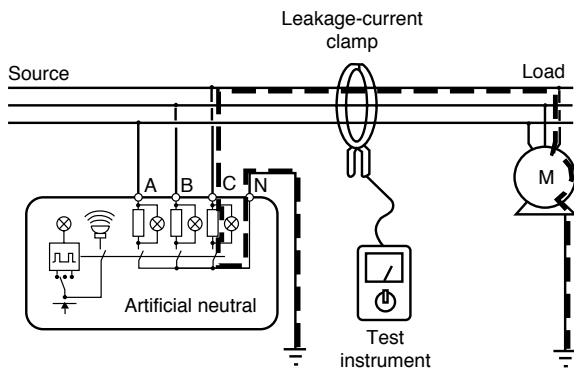

■ Electrical specifications

Operating voltage:
30 V at 600 V

Frequency range:
45 at 65 Hz

Resistance per phase:
3.9 k Ω \pm 5 %

Make/break period:
Slow position: 0.5 s
Fast position: 2.3 s

Battery:
12 V DC, 8 x 1.5 V "AA" batteries

Consumption:
180 mA

Battery life:
40 hours

■ Mechanical specifications

Reference temperature:
23 °C \pm 3 °C

Operating temperature:
0 °C to +50 °C, between 10 % and 90 % RH

Storage temperature:
-40 °C to +70 °C, between 10 % and 90 % RH

Self-extinguishing capability:
UL94 V0

Colour:
yellow

Dimensions:
220 x 136 x 150 mm

Weight:
1.3 Kg

■ Safety specifications

Dielectric test:
6 kV between the lead and the unit

Operating voltage:
600 V rms

To order	Reference
AN1 artificial neutral box with shoulder bag, batteries, set of leads, croc-clips and user's manual	P01298005
Accessories: spare shoulder bag n. 2	P01197201

Date : ____ / ____ / ____

ADDRESS DETAILS	
Surname: _____	Profession: _____
First name: _____	Sector of industry: _____
Company: _____	_____
Address: _____	_____
_____	_____
Town: _____	_____
Post code: _____	Tel: _____
Country: _____	Fax: _____

APPLICATION DETAILS
Description/comments: _____

DESIRED SPECIFICATION				
Type of measurement:	AC	DC	AC + DC	
Measurement range:	from _____ A to _____ A			
Accuracy:	_____ % of output signal			
Bandwidth:	from _____ Hz to _____ Hz			
Output signal:	AAC	V AC	V DC	
Number of calibres: _____	1 calibre: _____ A	Sensitivity: _____ /A		
	2 calibre: _____ A	Sensitivity: _____ /A		
	3 calibre: _____ A	Sensitivity: _____ /A		
Operating open circuit (or working) voltage of the installation where the measurements are to be carried out:				
230 V	400 V	600 V	1000 V	Other: _____ V
Diameter of measured conductor: _____ mm or dimensions: _____ x _____ mm				
Temperature of conductor in use: from _____ ° to _____ ° °C °F				
Output connector:	Colour:			
Safety sockets Ø 4 mm	Jaws:	Red CHAUVIN ARNOUX (standard)		
Length of lead 1.5 m + safety plug Ø 4 mm		Other: _____		
2 m coaxial lead with isolated BNC	Casing:	Grey CHAUVIN ARNOUX (standard)		
Other: _____		Other: _____		

DELIVERY FORMAT	
Without instruction manual	Packaging
With CHAUVIN ARNOUX instruction manual (standard)	Standard CHAUVIN ARNOUX cardboard box
With customized operating instructions	Plain cardboard box
CHAUVIN ARNOUX product marking (standard)	Other: _____
Customized brand markings (supply all plans, diagrams, logo, etc. necessary for personalisation)	_____

YOUR ORDER	
First delivery quantity: _____	Desired delivery time: _____
Quantity per year: _____	Frequency of deliveries: _____

FAX THIS PAGE TO: +33 1 46 27 73 89

CHAUVIN ARNOUX

From hand-held testers to electric power quality monitors, the Chauvin Arnoux Test & Measurement Division designs, develops and manufactures hand-held measurement instrumentation for electrical tradesmen, installers, industries and administrations (French Railroad Authority, education, French Electricity Board, automobile, telecommunications, etc.). Chauvin Arnoux® brand multimeters and testers have been specially oriented towards the requirements of the electrotechnics sectors, while Metrix® brand analyzers and oscilloscopes are aimed primarily at the electronics sectors.

Tel: +33 1 44 85 44 38 - Fax: +33 1 46 27 95 59 - www.chauvin-arnoux.fr

ENERDIS

Enerdis offers all the fixed switchboard equipment required by the electrical industry and the tertiary sector for measurement, inspection, data logging, metering and supervision on MV/LV electrical networks.

The Chauvin Arnoux® and Enerdis® brands both serve the whole range of professions in the electricity sector, including switchboard operators, industrial installers and electricity companies.

Tel: +33 1 75 60 10 30 - Fax: +33 1 46 66 62 49 - www.enerdis.com

PYRO-CONTRÔLE

Pyro-Contrôle designs, manufactures and commercializes temperature sensors and industrial temperature measurement and control systems.

From "made-to-measure" sensors to standardized products, the Pyro-Contrôle® and Chauvin Arnoux® brands are widely recognized in particularly demanding industries such as the chemicals sector, petrochemicals, glass-making, ceramics, metallurgy and nuclear energy.

Tel: +33 4 72 14 15 55 - Fax: +33 4 72 14 15 41 - www.pyro-controle.com

Chauvin Arnoux

A LOCAL SERVICE FOR A BETTER SERVICE

A centralized
contact

CHAUVIN ARNOUX
190, rue Championnet
75876 PARIS Cedex 18
www.chauvin-arnoux.fr

France
Tel.: 01 44 85 44 85
Fax: 01 46 27 73 89
info@chauvin-arnoux.fr

International
Tel.: +33 1 44 85 44 38
Fax: +33 1 46 27 95 59
export@chauvin-arnoux.fr

Contacts
in your country

MIDDLE EAST
Chauvin Arnoux Middle East
PO Box 60-154
1241 2020 JAL EL DIB (Beirut)
LEBANON
Tel.: (01) 89 04 25
Fax: (01) 89 04 24
camie@chauvin-arnoux.com
www.chauvin-arnoux.com

UNITED KINGDOM
Chauvin Arnoux Ltd
Unit 1 Nelson Ct, Flagship Sq,
Shaw Cross Business Pk
Dewsbury, West Yorkshire - WF12 7TH
Tel.: 01924 460 494
Fax: 01924 455 328
info@chauvin-arnoux.co.uk
www.chauvin-arnoux.com

USA
Chauvin Arnoux Inc
d.b.a AEMC Instruments
200 Foxborough Blvd.
Foxborough - MA 02035
Tel.: (508) 698-2115
Fax: (508) 698-2118
sales@aemc.com
www.aemc.com

Chauvin Arnoux

10 subsidiaries
Worldwide

AUSTRIA
Chauvin Arnoux Ges.m.b.H
Tel.: +43 1 61 61 9 61
Fax: +43 1 61 61 9 61-61
vie-office@chauvin-arnoux.at
www.chauvin-arnoux.at

CHINA
Shanghai Pu-Jiang
Enerdis Instruments Co. Ltd
Tel.: +86 21 65 21 51 96
Fax: +86 21 65 21 61 07
info@chauvin-arnoux.com.cn

GERMANY
Chauvin Arnoux GmbH
Tel.: +49 07851 99 26-0
Fax: +49 07851 99 26-60
info@chauvin-arnoux.de
www.chauvin-arnoux.de

ITALY
AMRA SpA
Tel.: +39 039 245 75 45
Fax: +39 039 481 561
info@amra-chauvin-arnoux.it
www.chauvin-arnoux.it

MIDDLE EAST
Chauvin Arnoux Middle East
Tel.: +961 1 890 425
Fax: +961 1 890 424
camie@chauvin-arnoux.com
www.chauvin-arnoux.com

SPAIN
Chauvin Arnoux Ibérica SA
Tel.: +34 902 20 22 26
Fax: +34 93 459 14 43
comercial@chauvin-arnoux.es
www.chauvin-arnoux.es

SCANDINAVIA
CA Mätssystem AB
Tel.: +46 8 50 52 68 00
Fax: +46 8 50 52 68 10
info@camatsystem.com
www.camatsystem.com

SWITZERLAND
Chauvin Arnoux AG
Tel.: +41 44 727 75 55
Fax: +41 44 727 75 56
info@chauvin-arnoux.ch
www.chauvin-arnoux.ch

UNITED KINGDOM
Chauvin Arnoux Ltd
Tel.: +44 1924 460 494
Fax: +44 1924 455 328
info@chauvin-arnoux.co.uk
www.chauvin-arnoux.com

USA
Chauvin Arnoux Inc
d.b.a AEMC Instruments
Tel.: +1 (508) 698-2115
Fax: +1 (508) 698-2118
sales@aemc.com
www.aemc.com